

Centre Number						Candidate Number				
Surname										
Other Names										
Candidate Signature										

For Examiner's Use	
Examiner's Initials	
Pages	Mark
3	
4 – 5	
6 – 7	
8 – 9	
10 – 11	
12 – 13	
14 – 15	
16 – 17	
18 – 19	
20 – 21	
22 – 23	
24 – 25	
TOTAL	



General Certificate of Secondary Education  
Foundation Tier  
June 2013

# Applications of Mathematics (Linked Pair Pilot)

# 93702F

# F

Unit 2      Geometry and Measures

Friday 14 June 2013      9.00 am to 10.30 am

<p><b>For this paper you must have:</b></p> <ul style="list-style-type: none"> <li>• a calculator</li> <li>• mathematical instruments.</li> </ul>	
---	--

### Time allowed

- 1 hour 30 minutes

### Instructions

- Use black ink or black ball-point pen. Draw diagrams in pencil.
- Fill in the boxes at the top of this page.
- Answer **all** questions.
- You must answer the questions in the spaces provided. Do not write outside the box around each page or on blank pages.
- Do all rough work in this book. Cross through any work that you do not want to be marked.
- If your calculator does not have a  $\pi$  button, take the value of  $\pi$  to be 3.14 unless another value is given in the question.

### Information

- The marks for questions are shown in brackets.
- The maximum mark for this paper is 80.
- The quality of your written communication is specifically assessed in Questions 4, 13 and 17.  
These questions are indicated with an asterisk (\*).
- You may ask for more answer paper, graph paper and tracing paper. These must be tagged securely to this answer book.
- You are expected to use a calculator where appropriate.

### Advice

- In all calculations, show clearly how you work out your answer.



J U N 1 3 9 3 7 0 2 F 0 1

WMP/Jun13/93702F

# 93702F

**Formulae Sheet: Foundation Tier**

**Area of trapezium** =  $\frac{1}{2}(a+b)h$

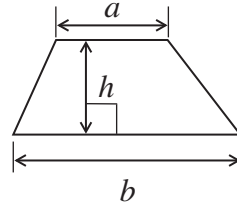

**Volume of prism** = area of cross-section  $\times$  length

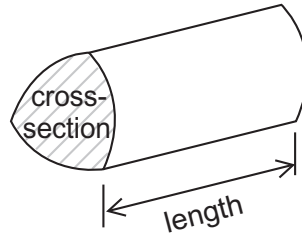

Answer **all** questions in the spaces provided.

1 Here is a sign on a fairground ride.

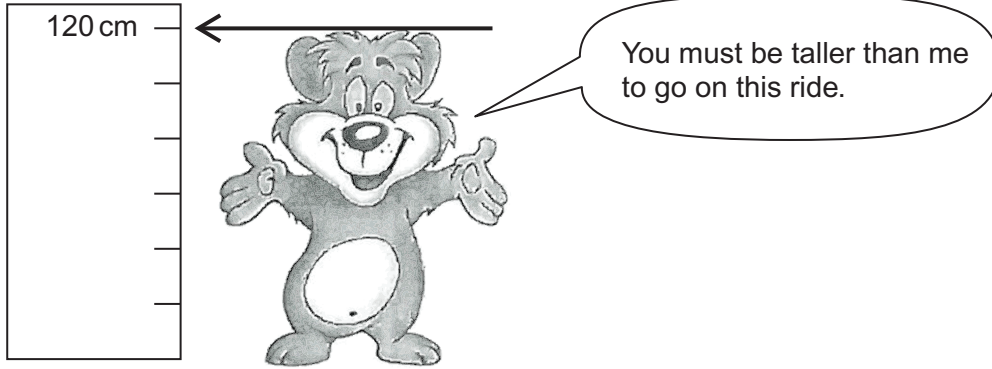

Joe

My height is 1 metre 26 centimetres.

Is Joe tall enough to go on the ride?  
 You **must** show your working.

.....

.....

.....

.....

(2 marks)

Turn over ►



2 In a puzzle, you put shapes together to make a rectangle.

The puzzle is shown on a centimetre grid.

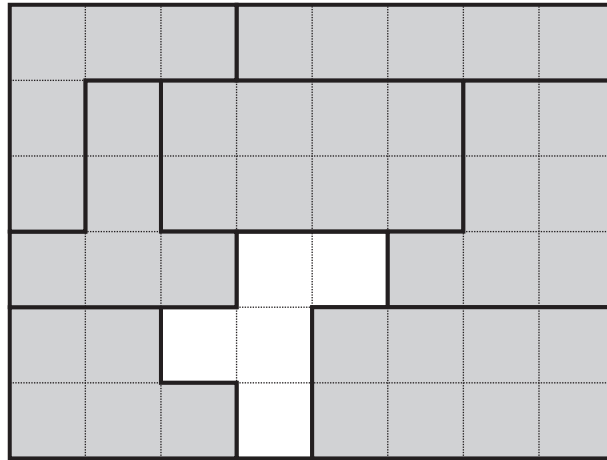

2 (a) One more shape will complete the puzzle.

Circle **two** shapes, either of which would complete the puzzle.

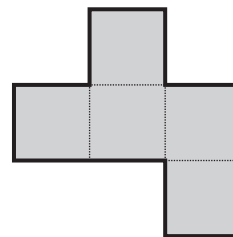
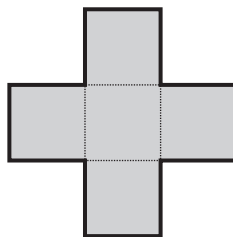
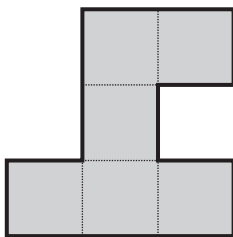
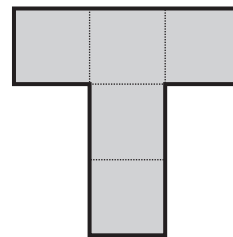
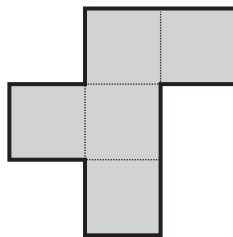
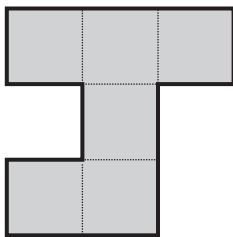

(2 marks)



2 (b) Here is one of the shapes.

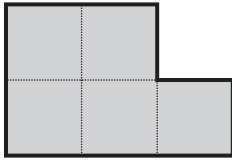

Work out the **perimeter** of this shape.

.....

Answer ..... cm (1 mark)

**Turn over for the next question**



- 3** Teachers in a school have pigeon holes for their post.

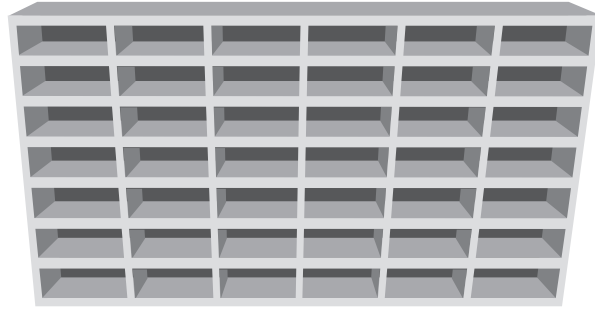

The diagram below represents the pigeon holes.

7						Kate
6		Tom				
5						
4				Emma		
3						
2						Dave
1						
	A	B	C	D	E	F

- 3 (a)** Tom has pigeon hole B6.

Which pigeon hole does Emma have?

Answer ..... (1 mark)

- 3 (b)** Kim has pigeon hole A5.

Write her name in the correct place on the diagram above.

(1 mark)



- 3 (c)** Sunil has a pigeon hole that is in
- the same column as Dave and Kate
  - the row between Tom and Emma.

Which pigeon hole does Sunil have?

Answer ..... (2 marks)

- 3 (d)** There are 39 teachers in the school.  
Each teacher has one pigeon hole.

How many of the pigeon holes are **not** used?

.....

.....

.....

.....

Answer ..... (2 marks)

**Turn over for the next question**



4 Here is some information about a football match.

City versus Rovers  
Attendance 28 375

4 (a) Write 28 375 to the nearest thousand.

Answer ..... (1 mark)

4 (b) Write 28 375 to the nearest hundred.

Answer ..... (1 mark)

\*4 (c) Molly goes to the match.

The match starts at 5.30 pm.  
It finishes 1 hour 45 minutes later.  
It will take her 3 hours 30 minutes to travel home.



Molly

The TV highlights start at 10 pm.

Will Molly be home by 10 pm?  
You **must** show your working.

.....  
.....  
.....  
.....  
.....  
.....

(4 marks)





5 Straight paths  $AB$ ,  $BC$ ,  $CD$  and  $DA$  are shown on the square grid.

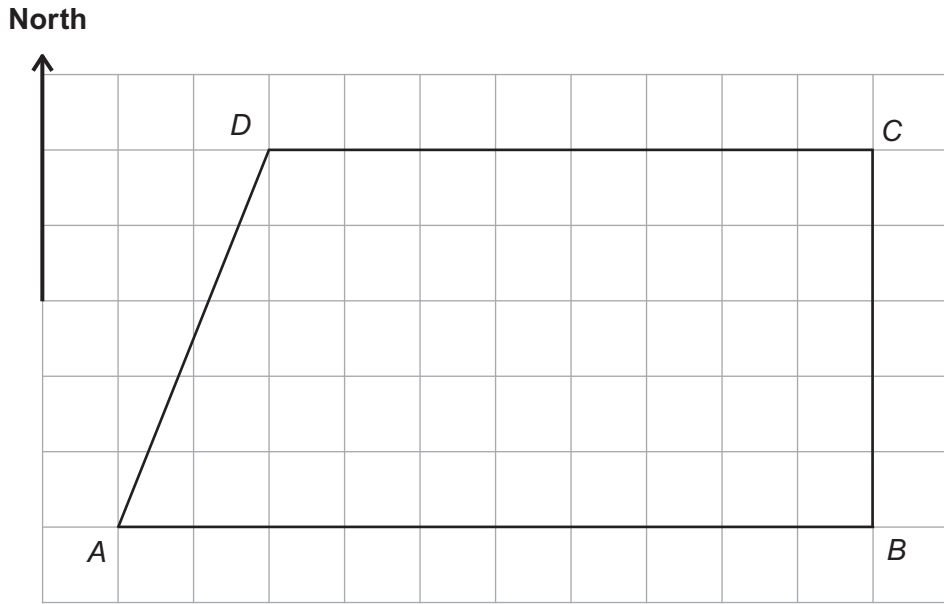

5 (a) Are these statements true or false?  
Tick a box for each statement.

	True	False
$A$ is due East of $B$	<input type="checkbox"/>	<input type="checkbox"/>
$B$ is due South of $C$	<input type="checkbox"/>	<input type="checkbox"/>

(2 marks)

5 (b) Which path is parallel to  $AB$ ?

Answer ..... (1 mark)

5 (c) Which path is at right angles to  $AB$ ?

Answer ..... (1 mark)

5 (d) Another straight path joins the midpoint of  $AB$  to the midpoint of  $DC$ .

Draw this path on the diagram.

(2 marks)



6

A Maths Club has a competition.

### Design a logo

The logo **must** have

- a large circle with **radius** between 4 cm and 8 cm
- a small circle with **diameter** between 45 mm and 55 mm
- the circles touching
- a **square** inside the small circle
- an **isosceles triangle** inside the large circle
- a **chord** inside the small circle.

This is Sam's design.

The dots show the centres of the circles.

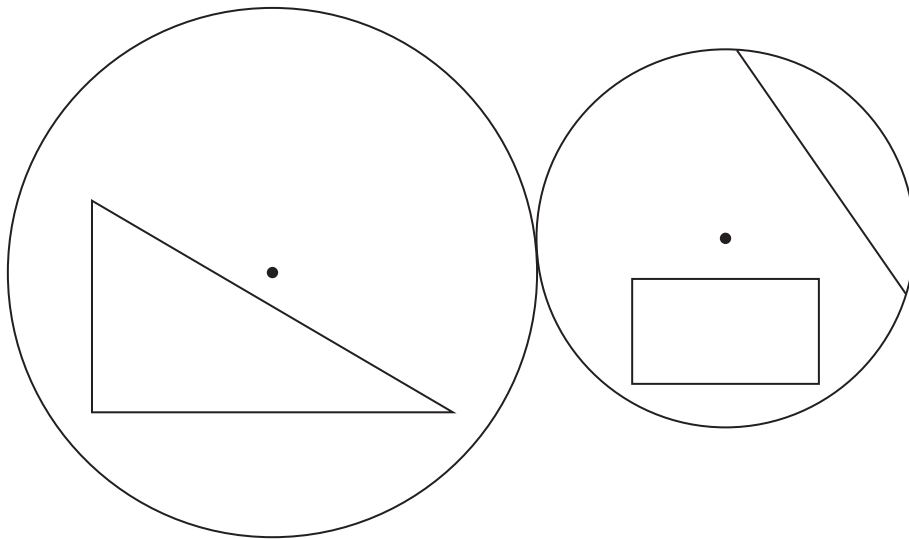

Check Sam's design.

Write YES or NO against each item in the list.  
One has been done for you.

- |   |       |
|---|-------|
| • A large circle with <b>radius</b> between 4 cm and 8 cm     | ..... |
| • A small circle with <b>diameter</b> between 45 mm and 55 mm | ..... |
| • The circles touching  | YES   |
| • A <b>square</b> inside the small circle                     | ..... |
| • An <b>isosceles triangle</b> inside the large circle        | ..... |
| • A <b>chord</b> inside the small circle                      | ..... |

(5 marks)

Turn over for the next question



7 Alan is on holiday in France.

7 (a) He sees this sign.

Paris 120 kilometres

How many miles is this?  
Use 8 kilometres = 5 miles

.....  
.....

Answer ..... miles (2 marks)

7 (b) He puts 48 litres of petrol in his car.

How many gallons is this?  
Use 1 litre = 0.22 gallons

.....  
.....

Answer ..... gallons (2 marks)



7 (c) This graph shows a journey he made to the coast.

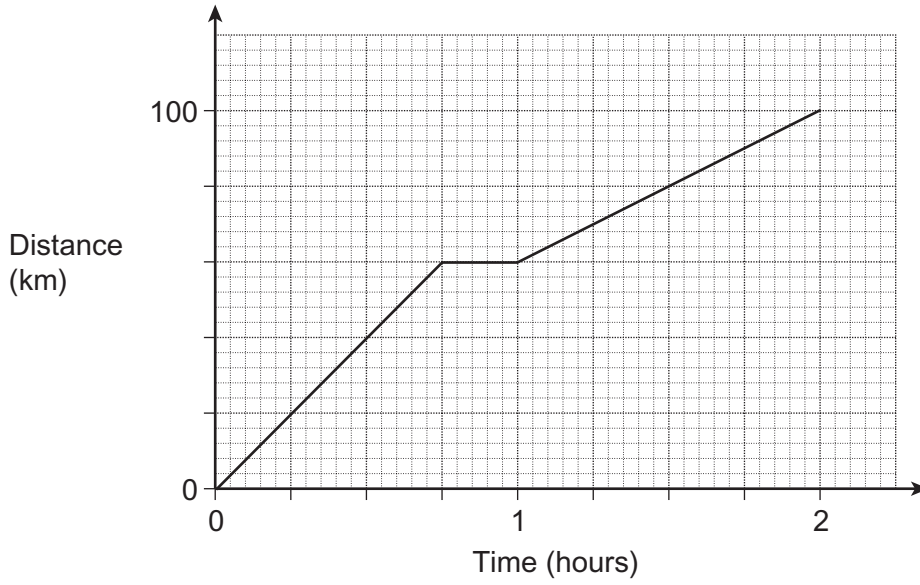

During the journey he stopped at a café.

For how long did he stop?  
State the units of your answer.

Answer ..... (2 marks)

Turn over for the next question



- 8** A wall is to be covered with 20 square tiles.  
The tiles are all the same size.  
The tiles are either white or black.

- 8 (a)** Shade **two more** black tiles so that the wall has exactly one line of symmetry.

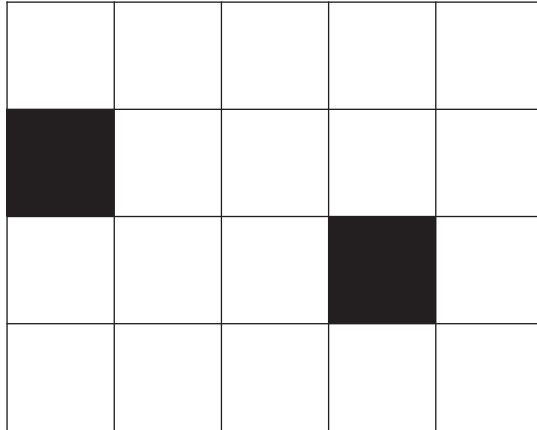

(2 marks)

- 8 (b)** Shade **four more** black tiles so that this wall has two lines of symmetry.

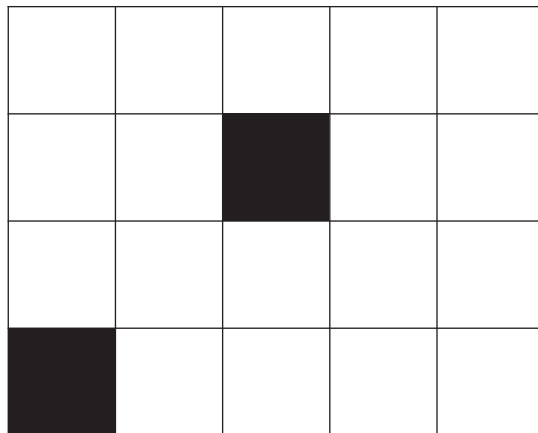

(2 marks)



**8 (c)** Shade **two more** black tiles so that this wall has rotational symmetry of order 2.

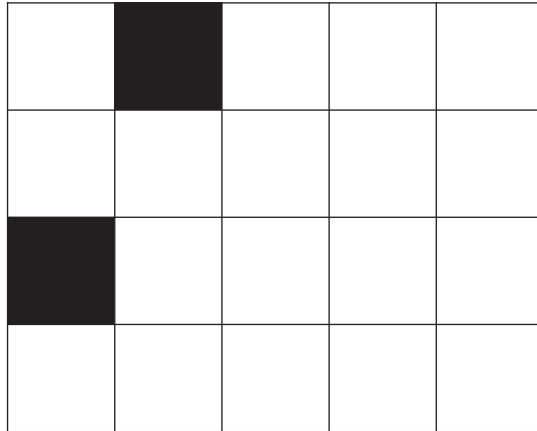

(2 marks)

**Turn over for the next question**



9 Mike wants to buy 20 litres of paint.

Shop A sells paint in 1-litre tins.



9 (a) How much would Mike pay for 20 litres of paint at Shop A?

.....

£ ..... (1 mark)

9 (b) Shop B sells the same paint in 5-litre tins.

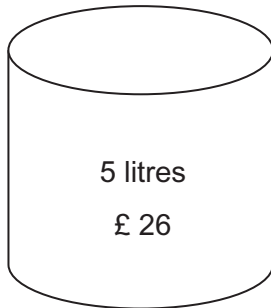

Mike says,

"It is cheaper to buy 20 litres of paint from Shop B."

Work out how much cheaper.

.....  
.....  
.....  
.....  
.....

£ ..... (3 marks)





**10** Howard has 460 marbles.  
157 are red  
148 are white  
the rest are blue.

After buying 20 more marbles, he has an **equal** number of each colour.

How many **blue** marbles did he buy?

.....

.....

.....

.....

.....

.....

.....

.....

.....

.....

.....

.....

.....

.....

.....

.....

.....

.....

.....

.....

.....

Answer ..... (5 marks)

**Turn over for the next question**



11 The graph shows the total pay (£), that Fatima receives for up to 35 hours worked.

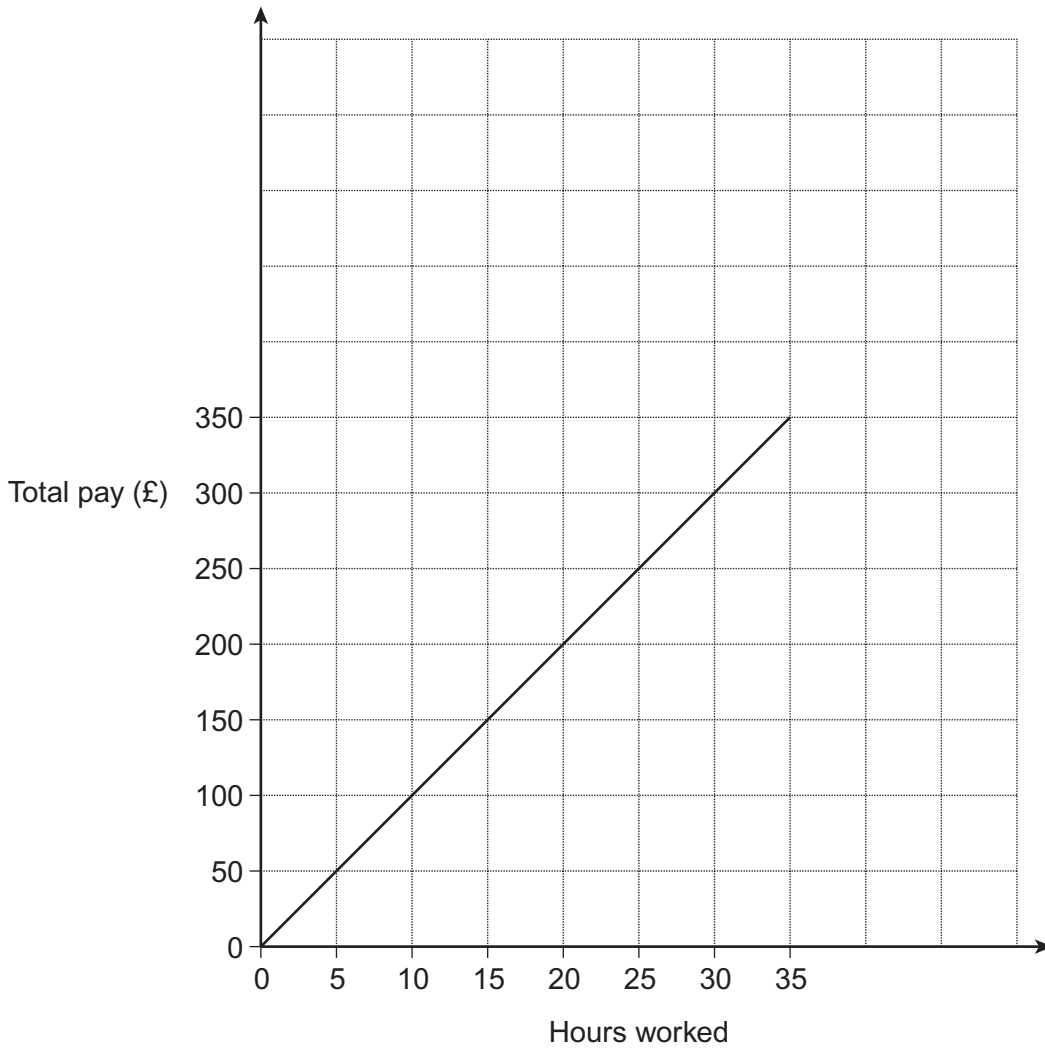

11 (a) How much is her total pay if she works for 35 hours?

£ ..... (1 mark)

11 (b) How much is she paid per hour?

.....

£ ..... (1 mark)



**11 (c)** She is paid £20 per hour for each hour she works above 35 hours.

Continue the graph for up to 45 hours worked.  
You **must** complete the scales on the axes.

.....

.....

.....

(4 marks)

**Turn over for the next question**

6
---

**Turn over ►**



**12** This diagram shows Adam's garden.  
It is in the shape of two rectangles joined together.

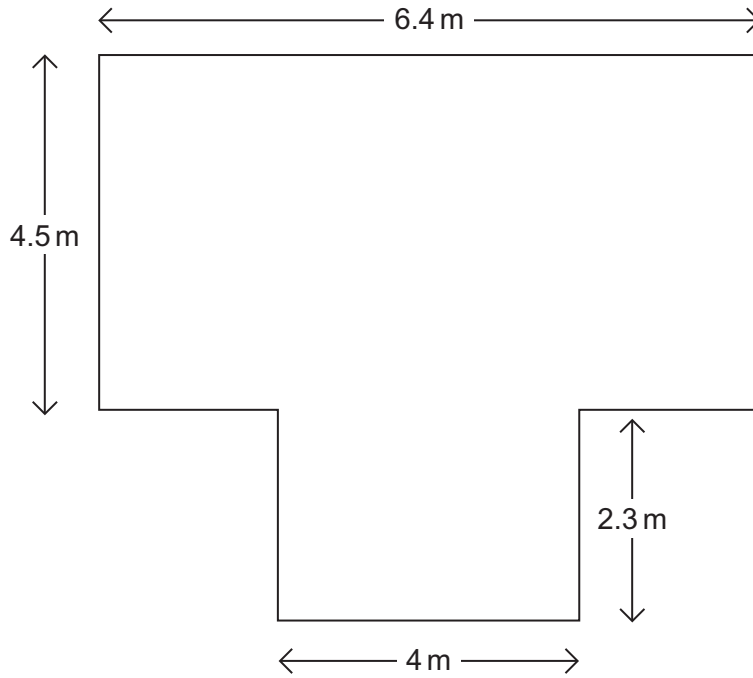

Not drawn  
accurately

**12 (a)** Work out the area of the garden.

.....  
.....  
.....  
.....

Answer ..... m<sup>2</sup> (2 marks)

**12 (b)** Adam makes a flower bed.  
It is a circle of radius 1.7 m.

Work out the area of the flower bed.

.....  
.....

Answer ..... m<sup>2</sup> (2 marks)



13 Two empty water tanks, A and B, are in the shape of cuboids as shown.

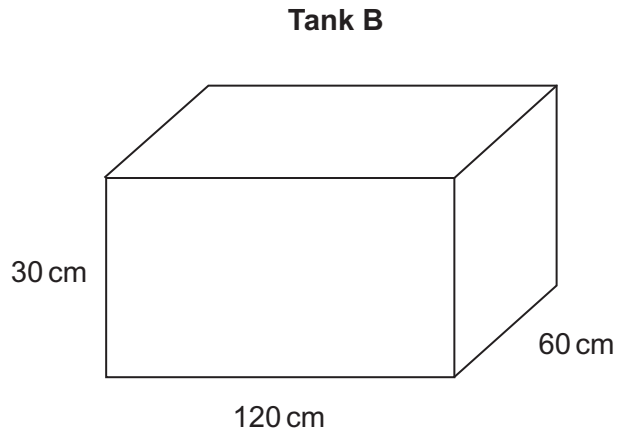
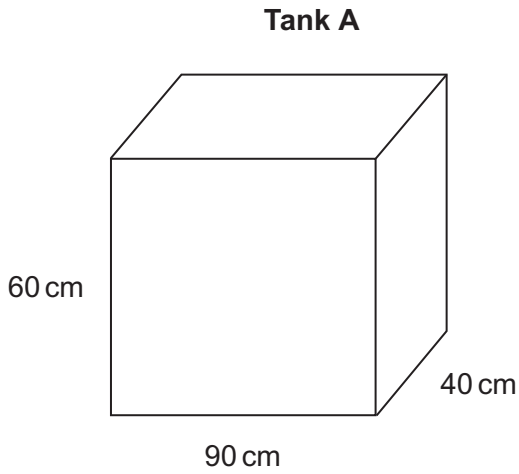

Each tank has water added at the same constant rate.

\*13 (a) Show that it takes the same time to fill each tank to the top. You **must** show your working.

.....

.....

.....

.....

.....

(3 marks)

13 (b) In which tank does the depth of water increase faster? Give a reason for your answer.

Tank .....

Reason .....

.....

(1 mark)

Turn over ►



14

**Ingredients for biscuits**

- 60 g of sugar
- 120 g of butter
- 180 g of flour



With these ingredients I can make  
40 small biscuits  
**or**  
20 large biscuits.

Tony

Tony wants to make 20 small biscuits **and** 15 large biscuits.

Work out how much of each ingredient he needs.  
You **must** show your working.

.....

.....

.....

.....

.....

.....

.....

.....

.....

.....

Sugar ..... g

Butter ..... g

Flour ..... g

(4 marks)



- 15 Sally makes **one** earring using  
 1 gold square  
 4 small silver triangles  
 1 large silver triangle.

A diagram of one of the earrings is shown on the square grid.

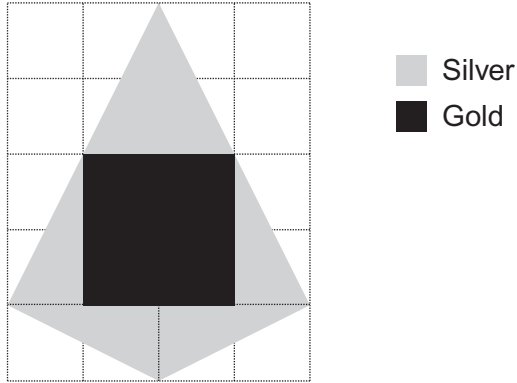

She cuts the shapes from these two sheets.

**Gold**

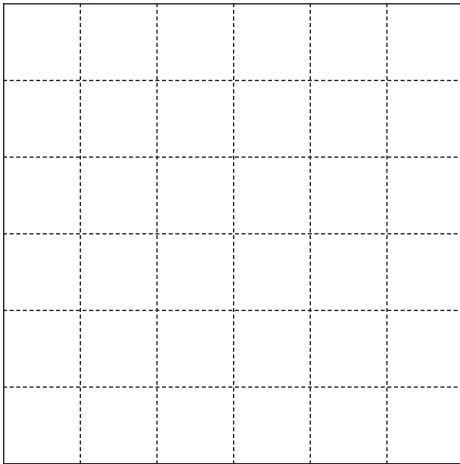

**Silver**

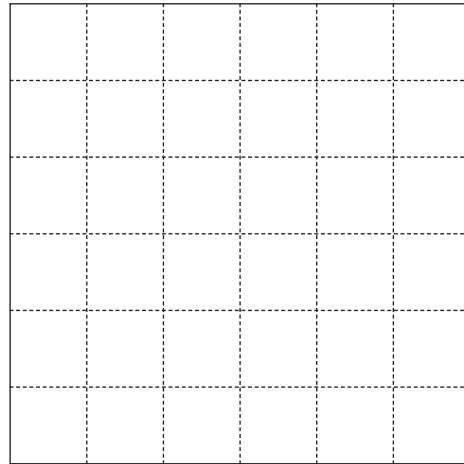

How many earrings can she make from the two sheets?  
 You **must** show your working on the grids above.

Answer ..... (4 marks)



16

You need compasses to answer this question.

The scale drawing shows the positions of three mobile phone masts A, B and C.  
The masts provide mobile phone coverage in a town.  
The town border is shown by the dotted line on the diagram.

Scale 1 cm represents 1 km

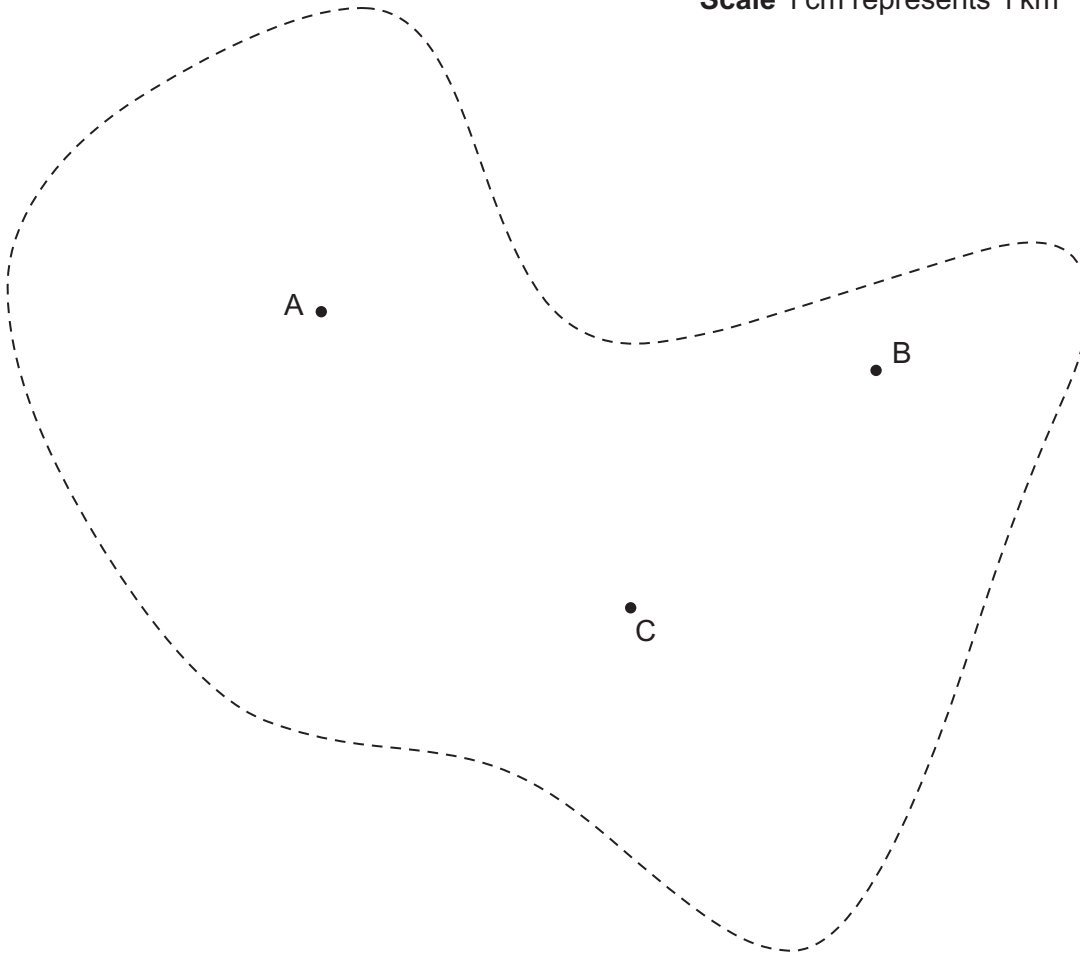

Places in the town have mobile phone coverage if they are

less than 4.5 km from A

**or**

less than 3.5 km from B

**or**

less than 3 km from C.

Shade the area in the town that does **not** have mobile phone coverage.

(4 marks)





- 17 Roads connect three villages P, Q and R.  
An expression for the distance, in miles, along each road is shown.

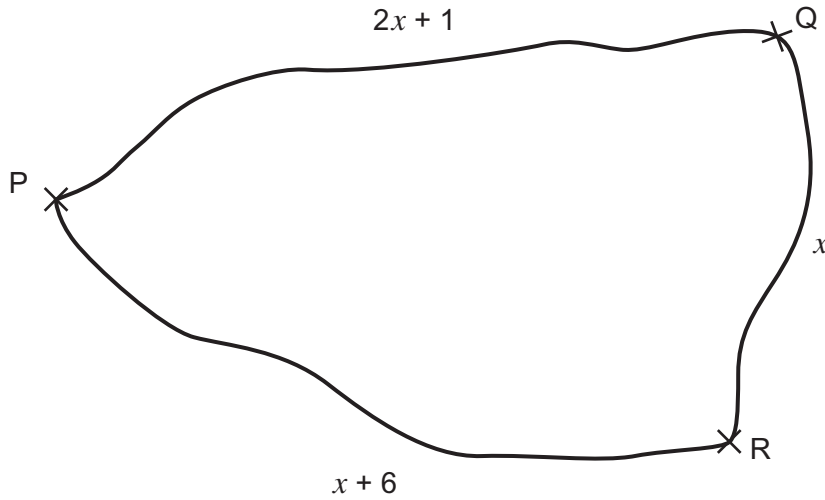

Not drawn accurately

Lucy cycles along all three roads.  
The total distance is 21 miles.

- \*17 (a) Set up and solve an equation to find the value of  $x$ .

.....

.....

.....

.....

.....

$x =$  ..... (4 marks)

- 17 (b) Work out the distance along the longest road.

.....

.....

Answer ..... miles (1 mark)

END OF QUESTIONS



**There are no questions printed on this page**

**DO NOT WRITE ON THIS PAGE  
ANSWER IN THE SPACES PROVIDED**



**There are no questions printed on this page**

**DO NOT WRITE ON THIS PAGE  
ANSWER IN THE SPACES PROVIDED**



**There are no questions printed on this page**

**DO NOT WRITE ON THIS PAGE  
ANSWER IN THE SPACES PROVIDED**

