

Centre Number						Candidate Number				
Surname										
Other Names										
Candidate Signature										



General Certificate of Secondary Education
Foundation Tier
November 2014

Methods in Mathematics (Linked Pair)

93652F

F

Unit 2 Geometry and Algebra

Wednesday 12 November 2014 9.00 am to 10.30 am

<p>For this paper you must have:</p> <ul style="list-style-type: none"> • a calculator • mathematical instruments. 	
---	--

Time allowed

- 1 hour 30 minutes

Instructions

- Use black ink or black ball-point pen. Draw diagrams in pencil.
- Fill in the boxes at the top of this page.
- Answer **all** questions.
- You must answer the questions in the spaces provided. Do not write outside the box around each page or on blank pages.
- Do all rough work in this book. Cross through any work that you do not want to be marked.
- If your calculator does not have a π button, take the value of π to be 3.14 unless another value is given in the question.

Information

- The marks for questions are shown in brackets.
- The maximum mark for this paper is 80.
- The quality of your written communication is specifically assessed in Questions 12, 16 and 20. These questions are indicated with an asterisk (*).
- You may ask for more answer paper, tracing paper and graph paper.
- These must be tagged securely to this answer book.
- You are expected to use a calculator where appropriate.

Advice

- In all calculations, show clearly how you work out your answer.

For Examiner's Use	
Examiner's Initials	
Pages	Mark
3	
4 – 5	
6 – 7	
8 – 9	
10 – 11	
12 – 13	
14 – 15	
16 – 17	
18 – 19	
20 – 21	
22 – 23	
24 – 25	
26 – 27	
TOTAL	



N 0 V 1 4 9 3 6 5 2 F 0 1

Formulae Sheet: Foundation Tier

Area of trapezium = $\frac{1}{2}(a+b)h$

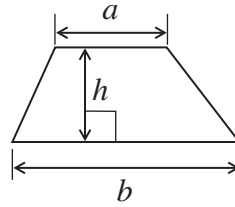

Volume of prism = area of cross section \times length

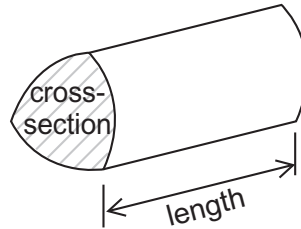

Answer **all** questions in the spaces provided.

1 (a) Circle the **two** numbers with a difference of 11

[1 mark]

15 24 27 35 49

1 (b) Circle the square number.

[1 mark]

15 24 27 35 49

1 (c) Circle the number that is a multiple of **both** 2 and 3

[1 mark]

15 24 27 35 49

1 (d) Circle the number that is a factor of 60

[1 mark]

15 24 27 35 49

Turn over for the next question



2 (a) Draw a line that is at right angles to PQ .

[1 mark]

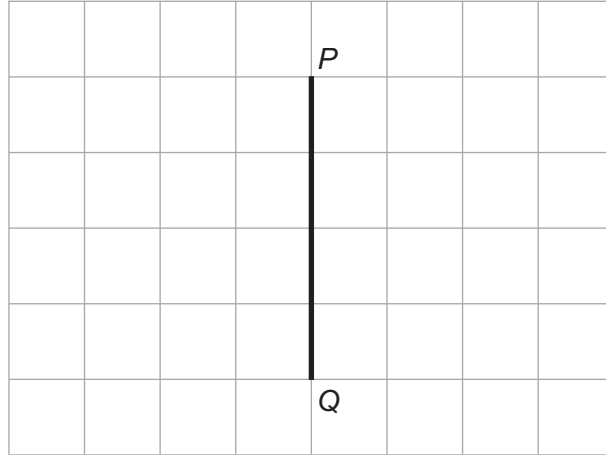

2 (b) Draw a line that is

parallel to AB
and
half as long as AB .

[2 marks]

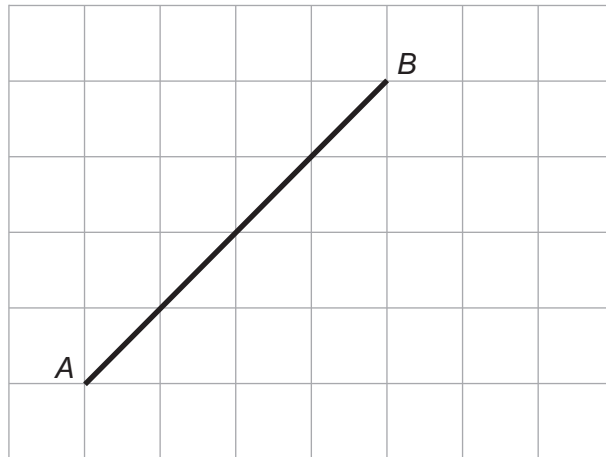

3 (a) Here is a number sequence.

1 3 6 10 15

Write down the **next** number in the sequence.

[1 mark]

Answer

3 (b) Here is part of a number sequence.

.... 7 11 15 19 23

7 is the **third** number in the sequence.

Work out the first number of the sequence.

[2 marks]

.....
.....

Answer

Turn over for the next question



4 Circle the word that makes each sentence true.

4 (a) The diameter of a circle is a straight line that passes through the **[1 mark]**

arc

centre

chord

radius

4 (b) The distance around the circle is the

[1 mark]

circumference

chord

radius

tangent

4 (c) The shaded area in the circle below is a

[1 mark]

chord

sector

segment

tangent

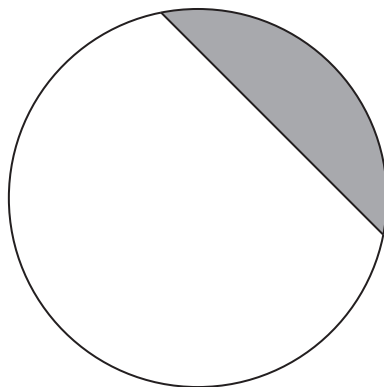

5 A, B and C are positive, whole numbers.
D = 7

- $A + B = D$
- $C + B = 5$
- $D - C = C - B$

Fill in the values of A, B and C in the table.

[3 marks]

.....

.....

.....

.....

.....

A	B	C	D
			7

Turn over for the next question



6 Shapes A, B, C, D, E and F are drawn on a centimetre grid.

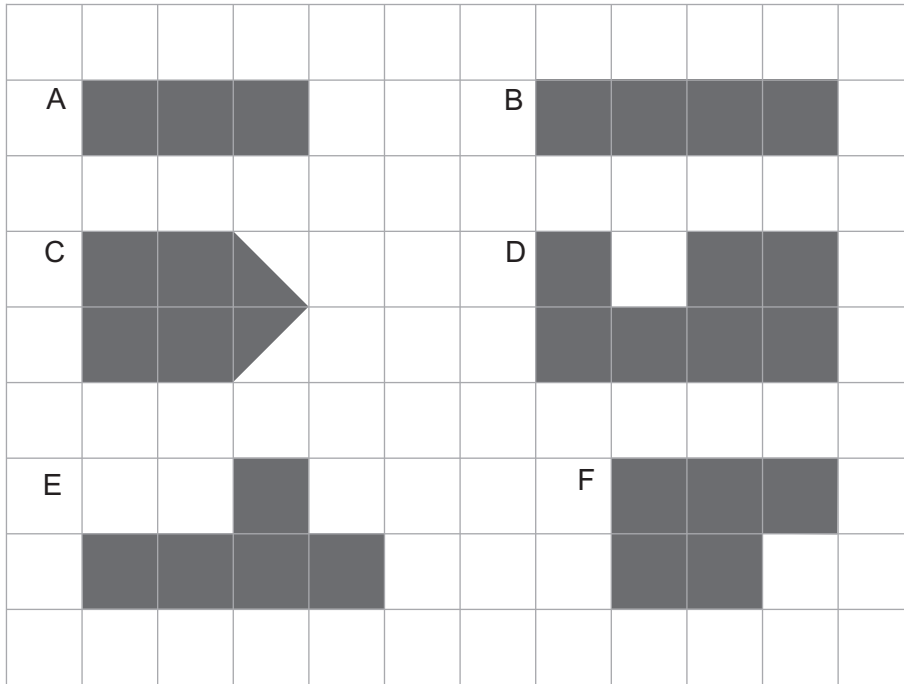

6 (a) Which **two** shapes have the same perimeter? [1 mark]

.....

Answer and

6 (b) Which **three** shapes each have an area of 5 cm²? [2 marks]

.....

Answer and and

6 (c) Which shape has exactly **one** line of symmetry? [1 mark]

Answer



6 (d) Show how shapes B, D and E can fit together to make a square.

[1 mark]

Use this grid for practice.

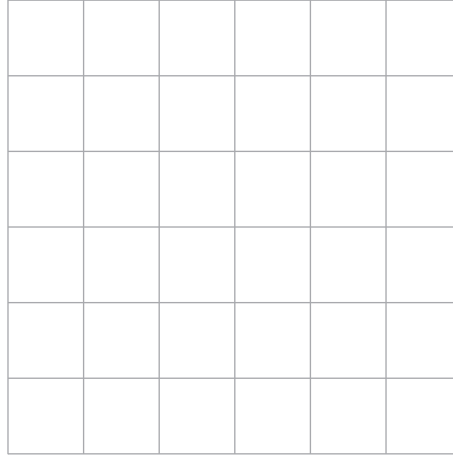

Use this grid for your answer.

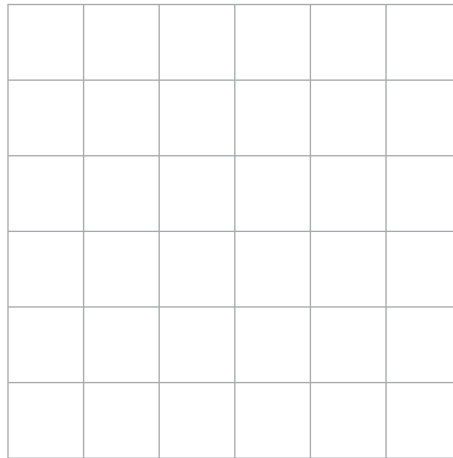

Turn over for the next question



7 (a) Which operation completes this calculation?

$$6 \square 3 + 3 = 5$$

Circle your answer.

[1 mark]

+

−

×

÷

7 (b) Work out the missing number.

$$3 \times 8 - 4 = (\square - 2) \times 4$$

[2 marks]

.....

.....

.....

Answer



8 (a) On the grid, draw a shape **congruent** to shape A.

[1 mark]

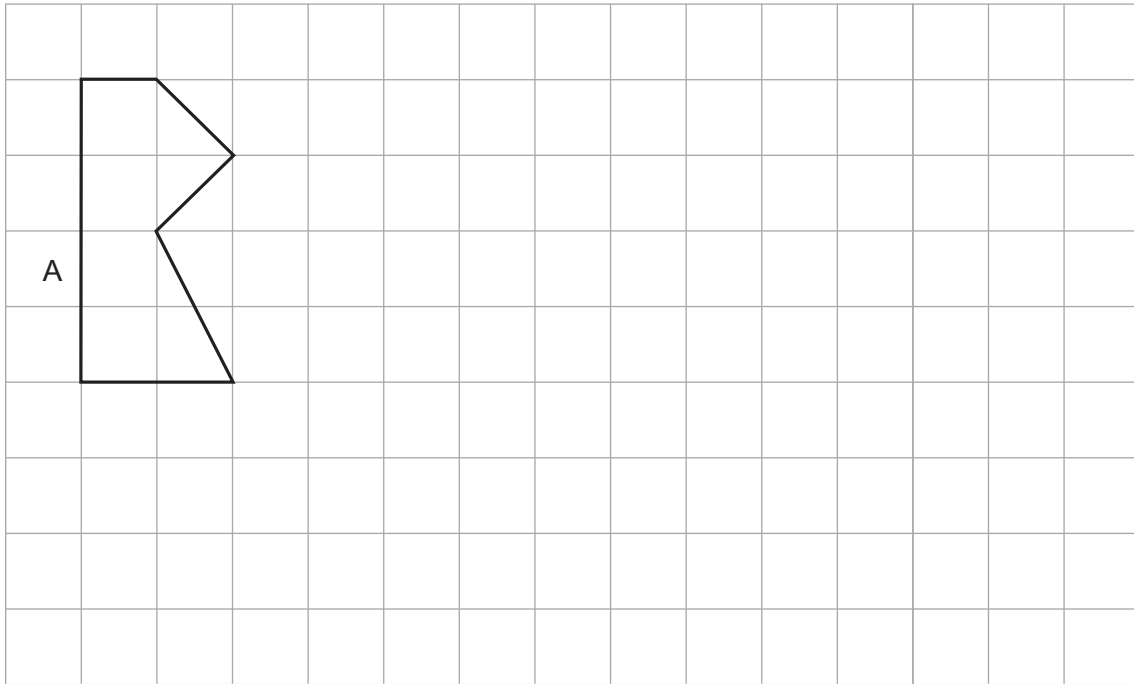

8 (b) On the grid, draw a shape **similar** to shape B.

[1 mark]

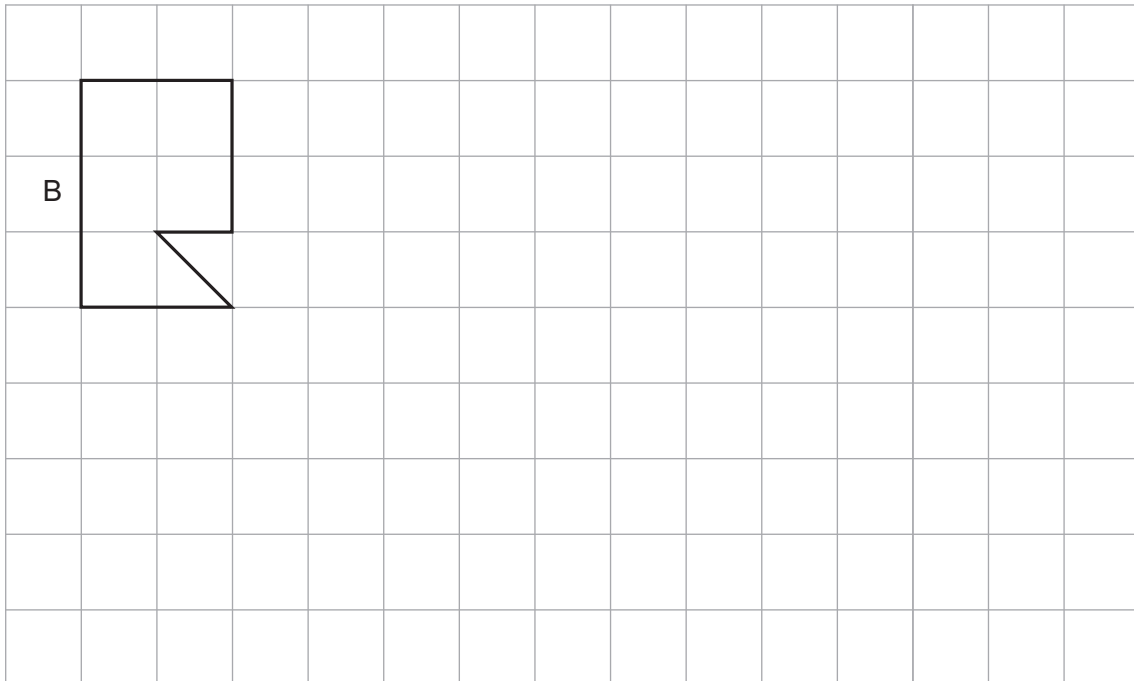

9 (a) Solve $4a = 30$

[1 mark]

.....

$a =$

9 (b) Solve $\frac{b}{3} = 12$

[1 mark]

.....

$b =$

9 (c) Solve $2c - 6 = 11$

[2 marks]

.....

.....

$c =$



10 (a) Use your calculator to work out 3.8^3
Write down your full calculator display.

[1 mark]

Answer

10 (b) Write your answer to (a) correct to one decimal place.

[1 mark]

.....

Answer

Turn over for the next question

6

Turn over ►



- 11 Three of the vertices of a rectangle are at $(1, 2)$, $(7, 2)$ and $(1, 6)$.
Work out the coordinates of the **centre** of the rectangle.

[3 marks]

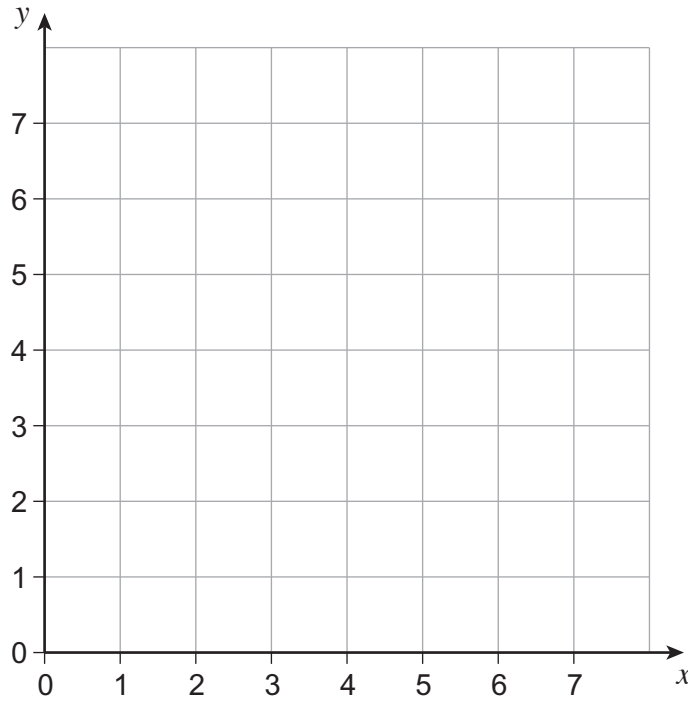

Answer (..... ,)



12 Here are three number machines.

*12 (a) Fill in an algebraic expression for the output.

[1 mark]

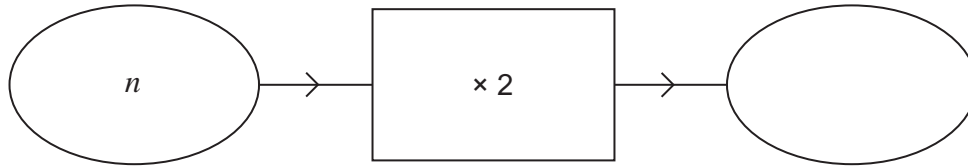

12 (b) Fill in an algebraic expression for the input.

[1 mark]

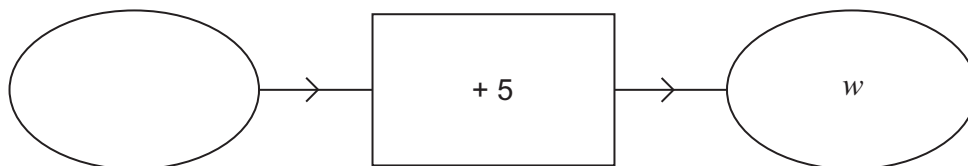

12 (c) Fill in an algebraic expression for the input.

[2 marks]

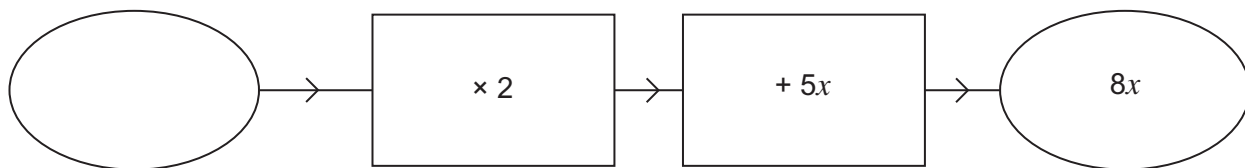

13 Calculate the area of a circle with radius 14 mm
State the units of your answer.

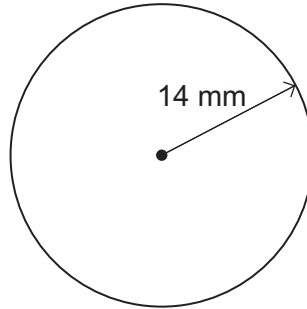

Not drawn
accurately

[3 marks]

.....
.....
.....

Answer



14 A square is split into 4 quarters.
One of these quarters is removed.
The remaining **area** is 108 cm^2

Not drawn
accurately

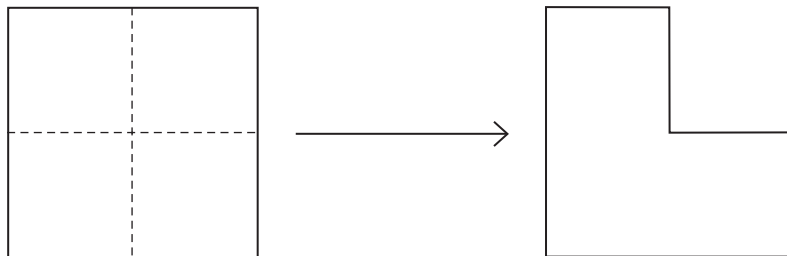

Area = 108 cm^2

Work out the **perimeter** of the original square.

[4 marks]

.....

.....

.....

.....

Answer cm

Turn over for the next question



15 (a) AB is a straight line.

Work out the size of angle x .

[1 mark]

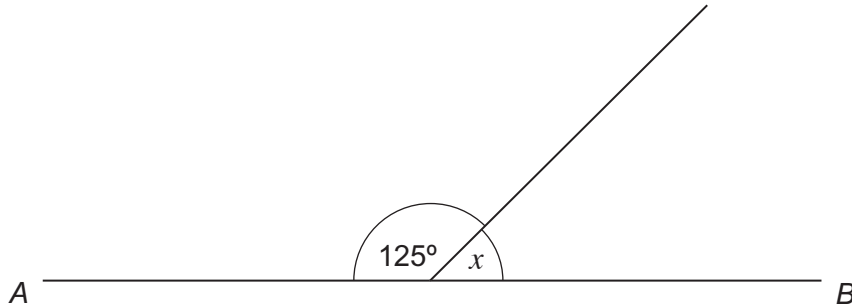

Answer degrees

15 (b) Work out the size of angle w .

[1 mark]

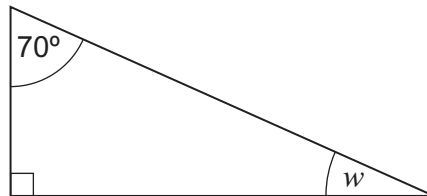

Answer degrees



15 (c) Work out the value of y .

[3 marks]

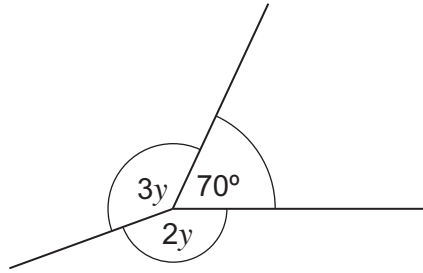

Not drawn accurately

.....

.....

.....

Answer degrees

*16 Work out which is the greater 24% of 360 or $\frac{4}{5}$ of 110
You **must** show your working.

[4 marks]

.....

.....

.....

.....

.....

.....

.....

.....

Answer

9

Turn over ►



17 Here are six quadrilaterals.

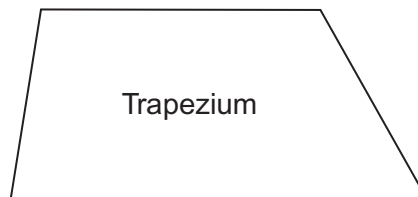
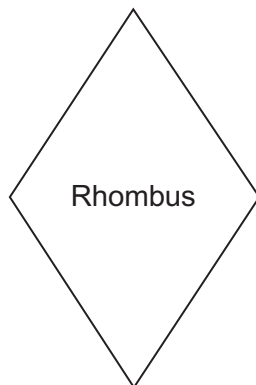
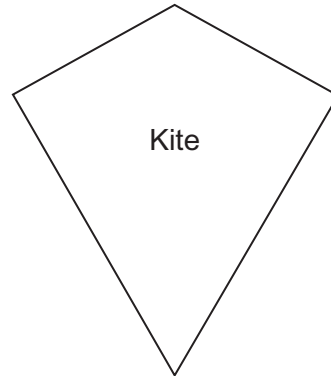
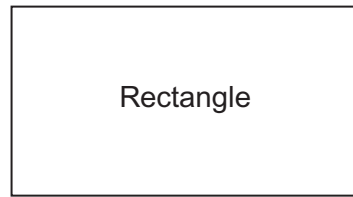
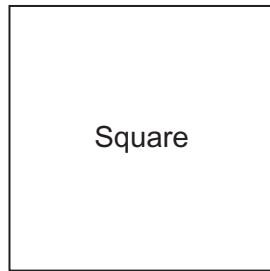

17 (a) Write down the names of the **two** quadrilaterals that have
rotational symmetry of order 2
and
diagonals of different lengths.

[2 marks]

Answer and



17 (b) Three of the quadrilaterals are

kite

rectangle

parallelogram

The kite could be the odd one out.
Give a reason why.

[1 mark]

.....

.....

.....

17 (c) Tick the **one** property that these quadrilaterals have in common.

rectangle

square

rhombus

[1 mark]

All four sides the same length

All four angles 90°

Diagonals bisect each other

No lines of symmetry

Turn over for the next question



18 The diagram shows a prism.

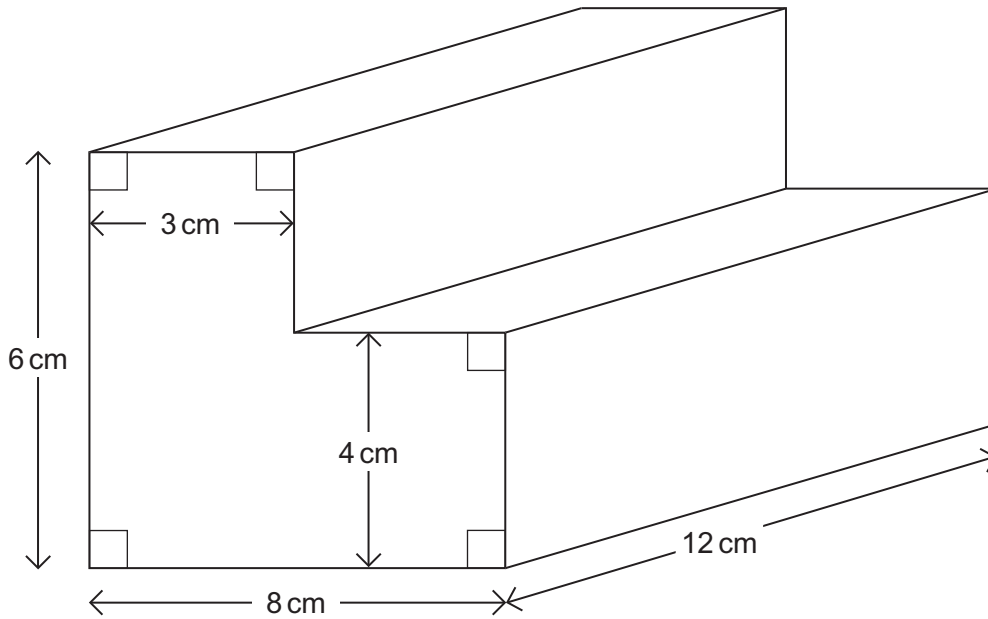

Work out the volume of the prism.
You **must** show your working.

[4 marks]

.....

.....

.....

.....

.....

.....

.....

.....

.....

Answer cm³



19 (a) Reflect shape A in the mirror line, M.

[2 marks]

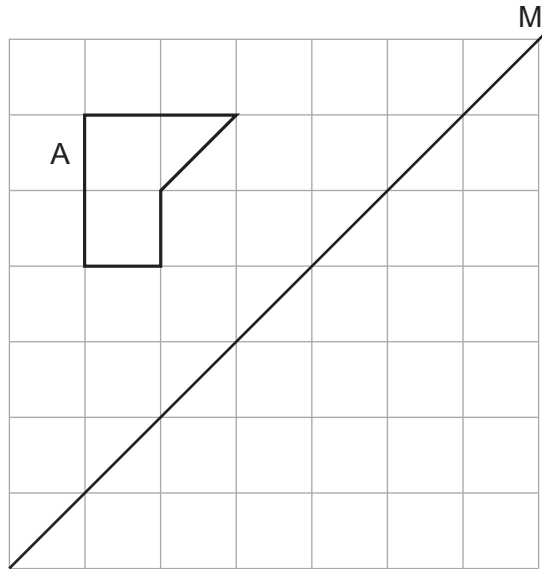

19 (b) Write down the vector that maps shape B to shape C.

[2 marks]

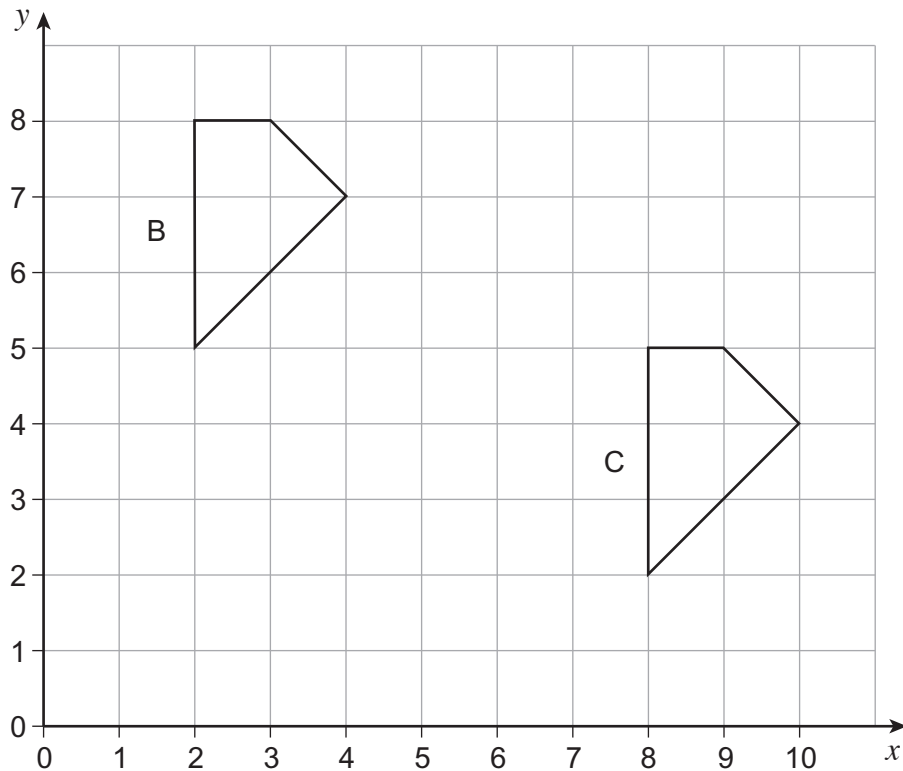

Answer $\begin{pmatrix} \dots \\ \dots \end{pmatrix}$

8

Turn over ►



*20

A cuboid has a net as shown.
The areas of two of the faces are shown on the net.
The lengths of the sides of the cuboid are whole numbers of centimetres greater than 1

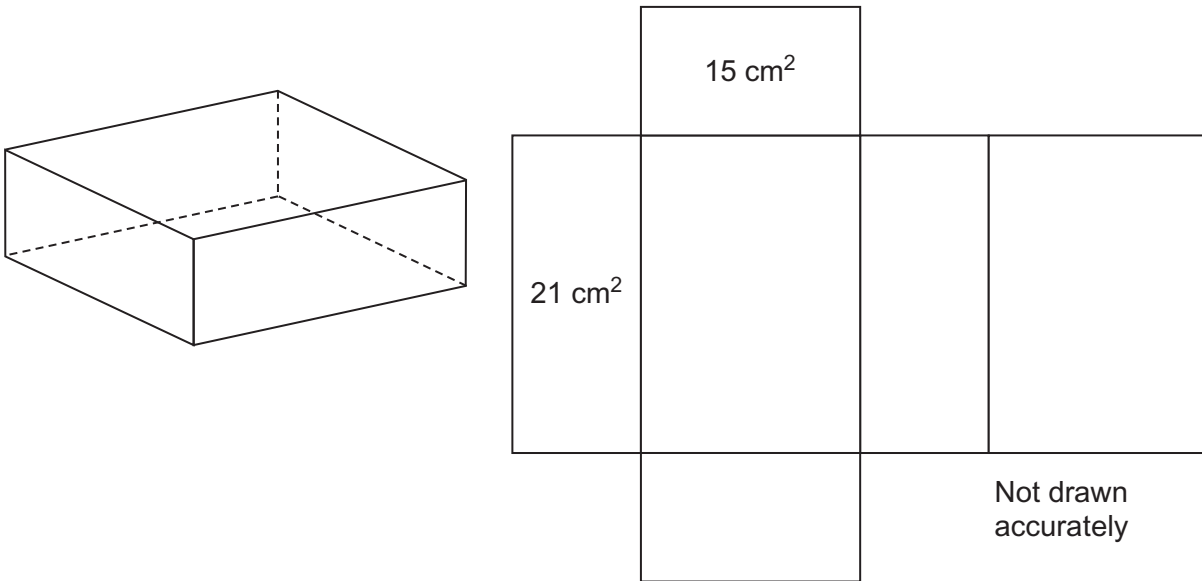

Work out the **total** surface area of the cuboid.
You **must** show your working.

[4 marks]

.....

.....

.....

.....

.....

.....

.....

Answer cm²



21 In the Venn diagram,

ξ = square and triangular shapes
 B = black shapes
 T = triangular shapes

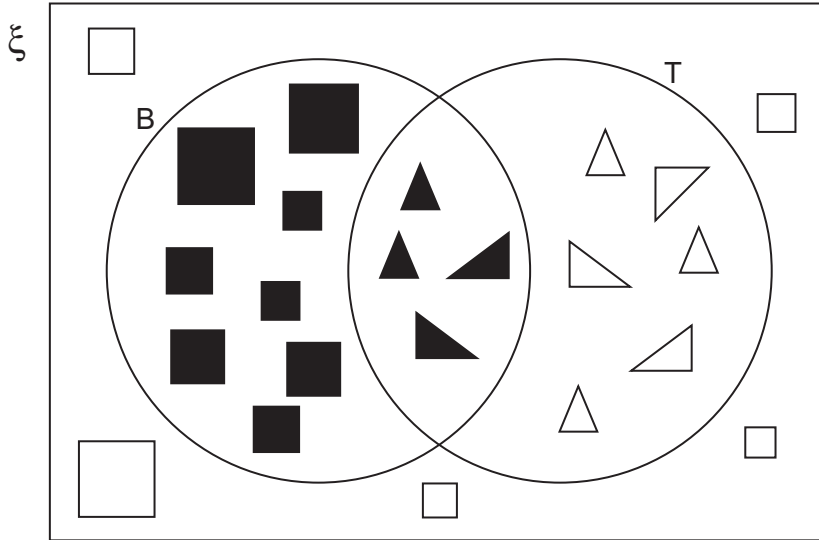

21 (a) How many shapes are black or triangular or both?

[1 mark]

Answer

21 (b) More **black** shapes are added to the Venn diagram.

The ratio black squares : black triangles does not change.

What is the smallest number of shapes that could have been added?
 You **must** show your working.

[2 marks]

.....

Answer

Turn over for the next question



22 Written as a product of prime factors $2014 = 2 \times 19 \times 53$

Work out **all** the factors of 2014

[3 marks]

.....

.....

.....

.....

.....

.....

.....

Answer

.....



23 Work out the length of x .

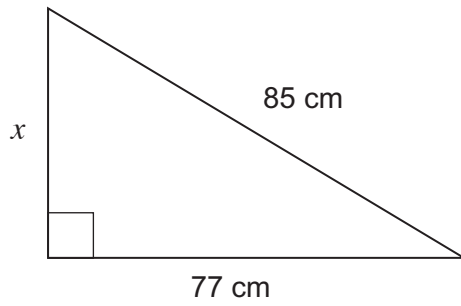

Not drawn
accurately

[3 marks]

.....

.....

.....

.....

Answer cm

END OF QUESTIONS



There are no questions printed on this page

**DO NOT WRITE ON THIS PAGE
ANSWER IN THE SPACES PROVIDED**

