

Centre Number						Candidate Number				
Surname										
Other Names										
Candidate Signature										

For Examiner's Use	
Examiner's Initials	
Pages	Mark
3	
4 – 5	
6 – 7	
8 – 9	
10 – 11	
12 – 13	
14 – 15	
16 – 17	
18 – 19	
20 – 21	
22 – 23	
TOTAL	



General Certificate of Secondary Education
Foundation Tier
November 2014

Mathematics

43603F

Unit 3 Foundation Tier

F

Wednesday 12 November 2014 9.00 am to 10.30 am

<p>For this paper you must have:</p> <ul style="list-style-type: none"> • a calculator • mathematical instruments. 	
---	--

Time allowed

- 1 hour 30 minutes

Instructions

- Use black ink or black ball-point pen. Draw diagrams in pencil.
- Fill in the boxes at the top of this page.
- Answer **all** questions.
- You must answer the questions in the spaces provided. Do not write outside the box around each page or on blank pages.
- Do all rough work in this book. Cross through any work that you do not want to be marked.
- If your calculator does not have a π button, take the value of π to be 3.14 unless another value is given in the question.

Information

- The marks for questions are shown in brackets.
- The maximum mark for this paper is 80.
- Quality of your written communication is specifically assessed in questions 9, 11, 14 and 19. These questions are indicated with an asterisk (*).
- You may ask for more answer paper, graph paper and tracing paper. These must be tagged securely to this answer booklet.

Advice

- In all calculations, show clearly how you work out your answer.



Formulae Sheet: Foundation Tier

Area of trapezium = $\frac{1}{2}(a+b)h$

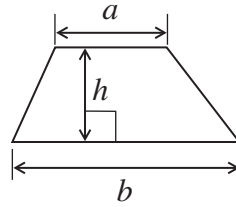

Volume of prism = area of cross section \times length

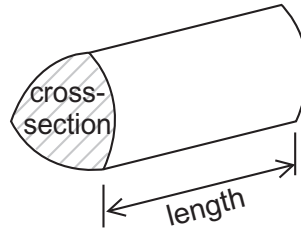

Answer **all** questions in the spaces provided.

- 1 The diagram shows shape *ABCDE*.

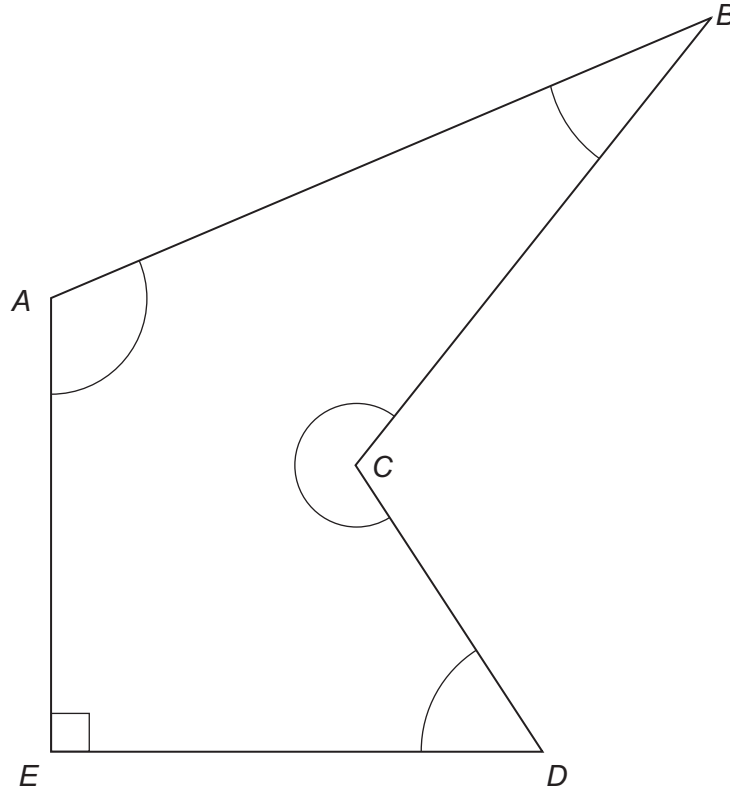

- 1 (a) Complete each sentence using a letter.

[3 marks]

Angle is a right angle.

Angle is an obtuse angle.

Angle is a reflex angle.

- 1 (b) Circle the name of shape *ABCDE*.

[1 mark]

Hexagon

Octagon

Pentagon

Kite



2

A is the point (2, 9)

B is the point (6, 5)

ABC is a straight line.

$$AB = BC$$

Work out the coordinates of point C.

You may use the grid to help you.

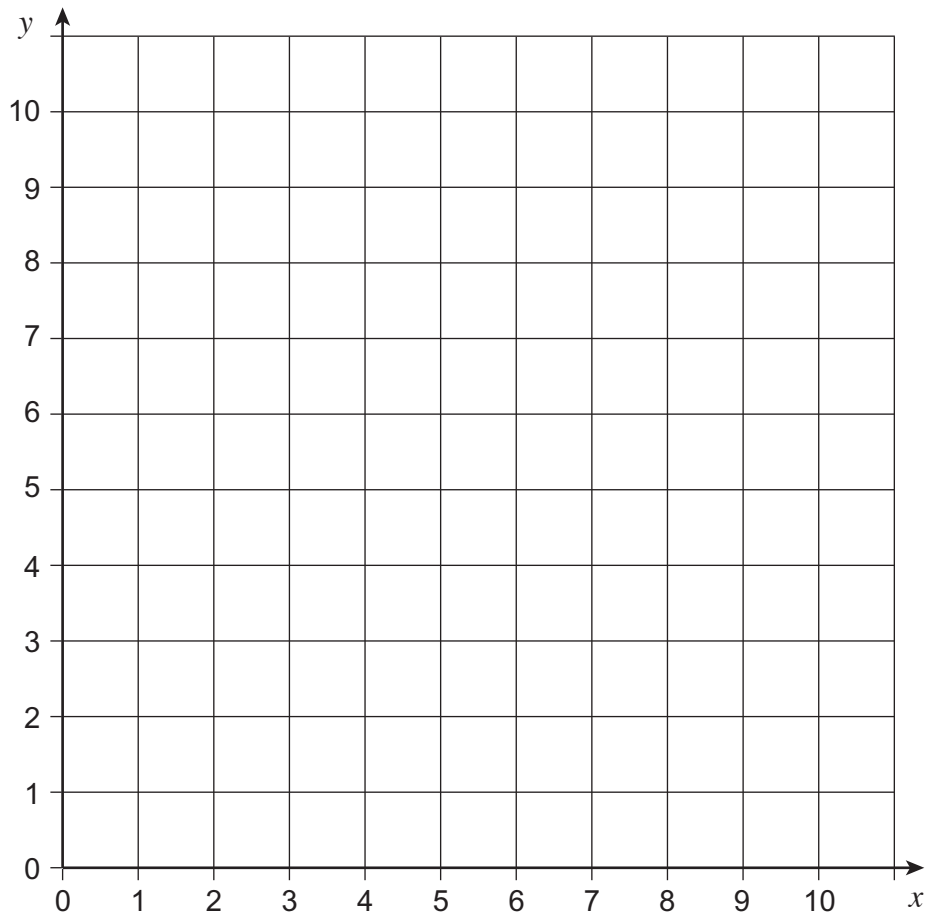
[2 marks]

Answer (..... ,)



3 Here are some shapes.

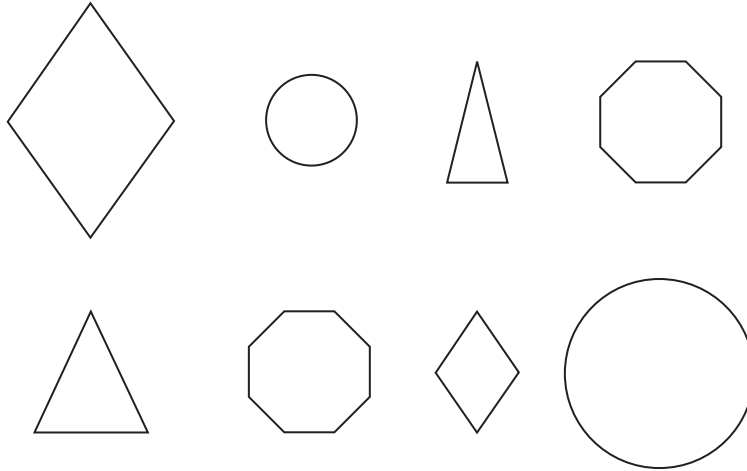

In each part, decide whether the shapes shown are similar, congruent or neither.

Circle your answers.

3 (a) The triangles are **[1 mark]**

similar

congruent

neither

3 (b) The circles are **[1 mark]**

similar

congruent

neither

3 (c) The rhombuses are **[1 mark]**

similar

congruent

neither

3 (d) The octagons are **[1 mark]**

similar

congruent

neither



4 A company makes tins in six different sizes.

For each increase in size, the capacity of the tin **doubles**.

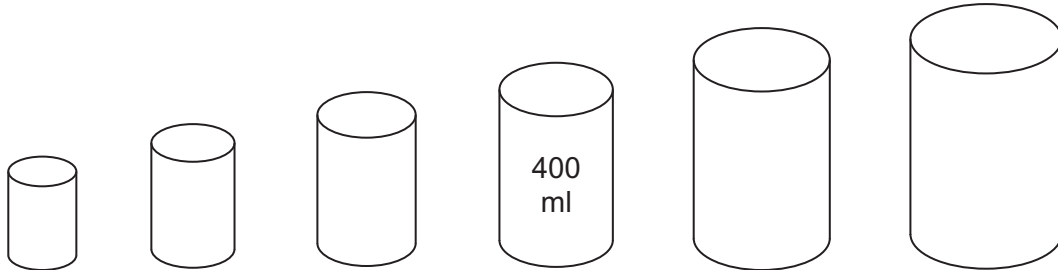

4 (a) Work out the capacity of the smallest tin.

[2 marks]

.....

Answer ml

4 (b) Work out the capacity of the largest tin.
Give your answer in litres.

[2 marks]

.....

.....

Answer litres



5 The diagram shows a road from *A* to *D*.
 The distance from *A* to *D* is 35 miles.
 The distance from *C* to *D* is 12 miles.

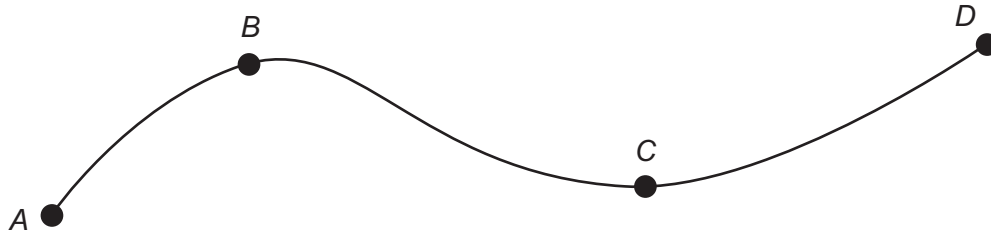

5 (a) Work out the distance from *A* to *C*.

[1 mark]

.....

Answer miles

5 (b) Each day

Amy drives from *A* to *D* and back to *A*
 Bilal drives from *B* to *D* and back to *B*.

Over **five** days Amy drives 80 miles **more** than Bilal.

Work out the distance from *B* to *D*.

[3 marks]

.....

Answer miles



- 6 Points A and B are shown on the grid.

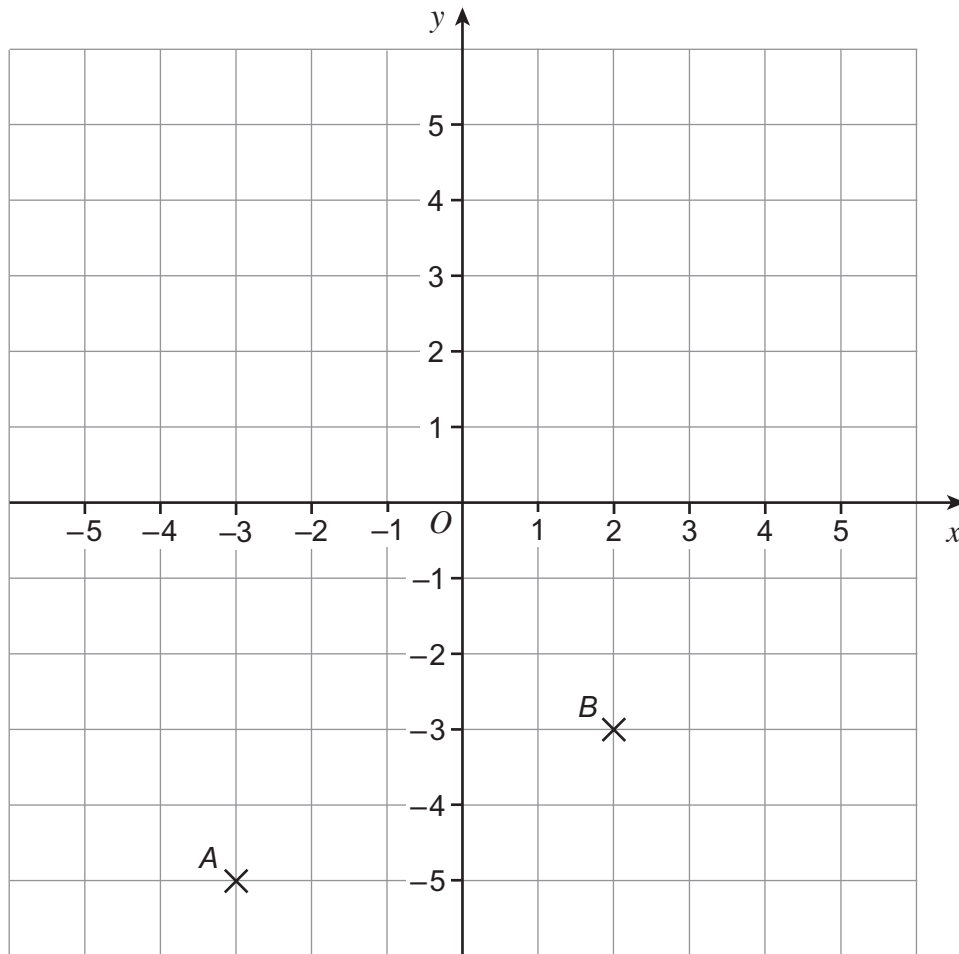

- 6 (a) Write down the coordinates of A and B .

[2 marks]

Answer A (..... ,)

B (..... ,)

- 6 (b) Plot point C on the grid so that
- the x -coordinate of C is less than the x -coordinate of A
 - and the y -coordinate of C is positive and even.

[2 marks]



7 Rectangle *B* is an enlargement of rectangle *A*.

Not drawn accurately

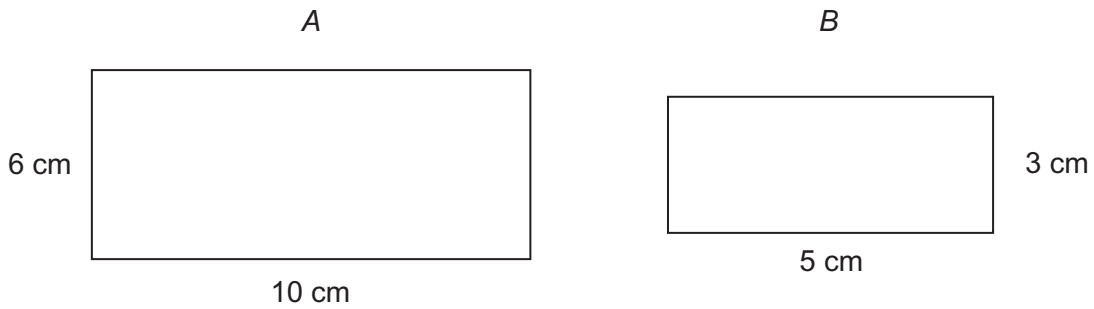

7 (a) Write down the scale factor of the enlargement from rectangle *A* to rectangle *B*.

[1 mark]

Answer

7 (b) Work out the ratio area of rectangle *A* : area of rectangle *B*

Give your answer in its simplest form.

[3 marks]

.....

.....

.....

.....

Answer :



8

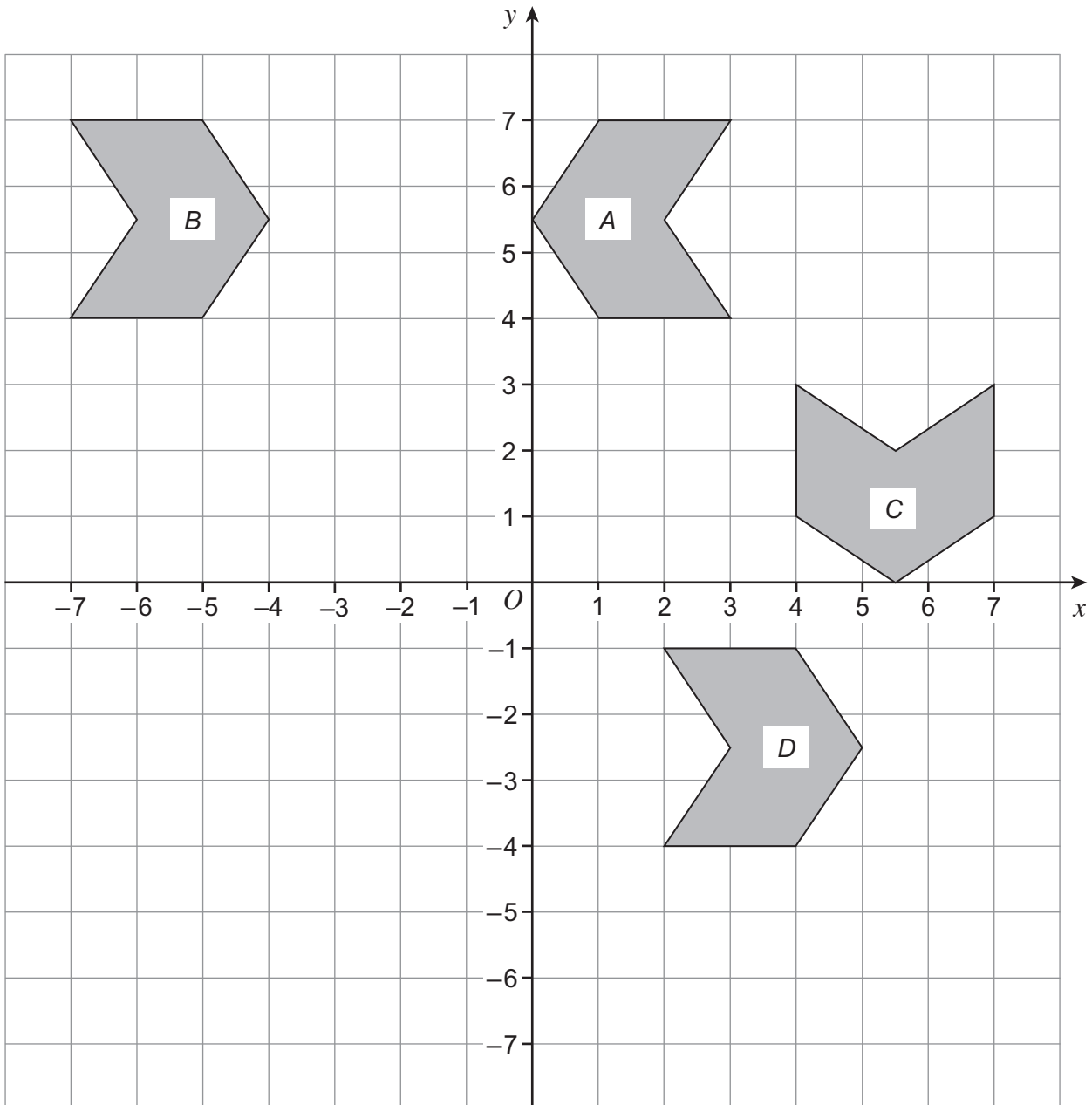

8 (a) On the grid draw the mirror line that reflects shape *A* to shape *B*.

[1 mark]

8 (b) On the grid draw the mirror line that reflects shape *A* to shape *C*.

[1 mark]



8 (c) Describe fully the single transformation that takes shape *B* to shape *D*.

[2 marks]

.....

.....

.....

Turn over for the next question

4

Turn over ►



9 Gas bills are calculated from the number of kilowatt hours used.

***9 (a)** The first 2700 kilowatt hours of gas cost 8p each.
Extra kilowatt hours of gas cost 5p each.

A family uses 5850 kilowatt hours of gas.

Work out their gas bill.

[4 marks]

.....

.....

.....

.....

.....

Answer £

9 (b) Here is a formula for working out the profit a gas company makes from each bill.

$$\text{profit} = \text{bill} \times 0.07$$

What percentage of each gas bill is profit?

[1 mark]

Answer %



10

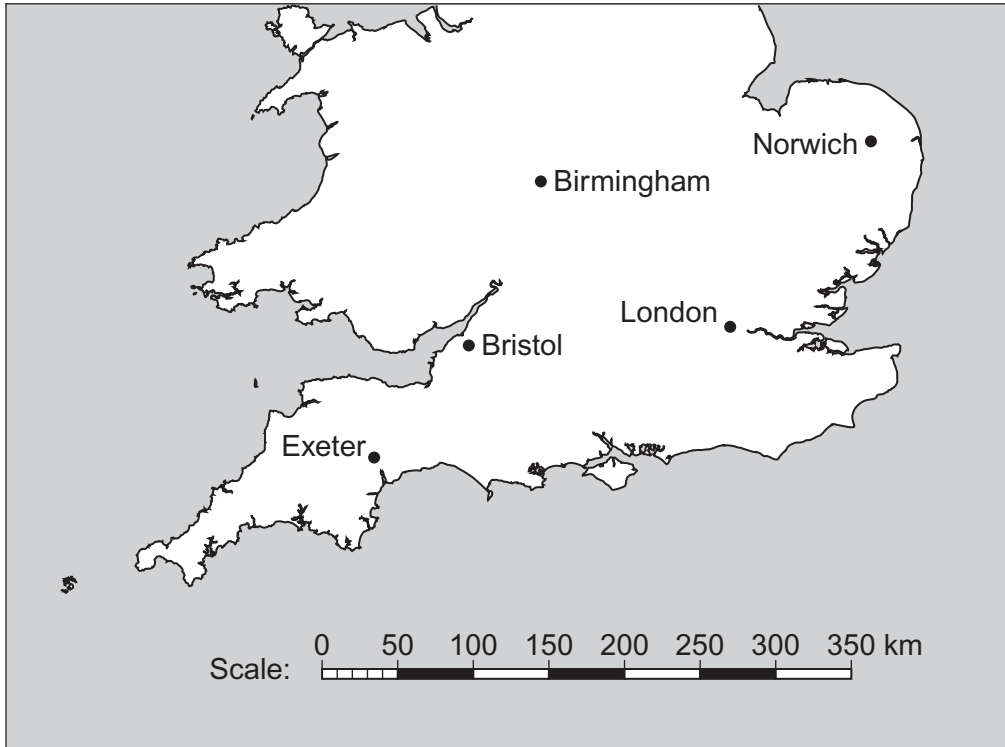

Work out the straight line distance between Exeter and Norwich.
Give your answer in kilometres.

[3 marks]

.....

.....

.....

.....

Answer km

8

Turn over ►



*11 The diagram shows quadrilateral Q and triangle T joined together.

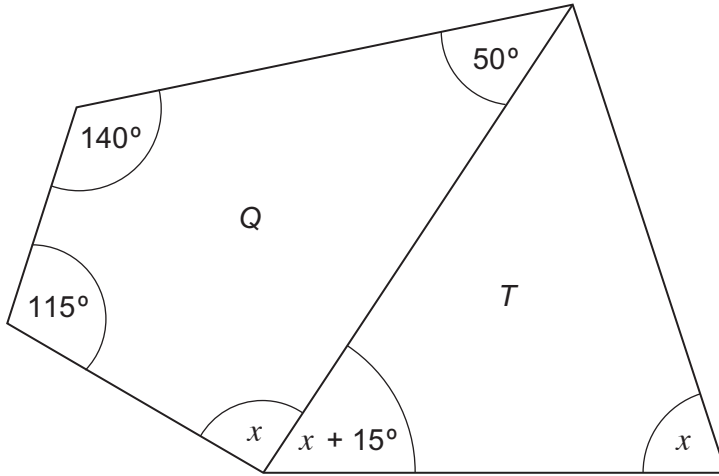

Not drawn accurately

What type of triangle is T ?
You **must** show your working, which may be on the diagram.

[5 marks]

.....

.....

.....

.....

.....

.....

Answer



12

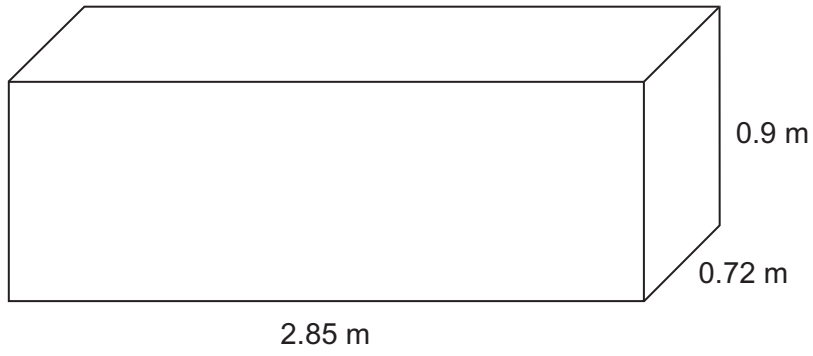

Work out the volume of the cuboid.
State the units of your answer.

[3 marks]

.....

.....

.....

Answer

Turn over for the next question



13 The diagram shows two aircraft, *A* and *B*, travelling in opposite directions.

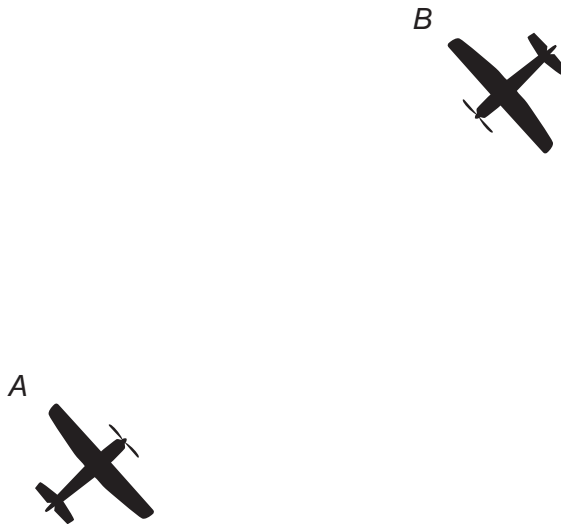

Aircraft *B* is on a bearing of 225° (South West).

13 (a) Work out the three-figure bearing of aircraft *A*.

[2 marks]

.....

.....

Answer $^\circ$

13 (b) Aircraft *B* turns 60° clockwise.

Work out the new three-figure bearing of aircraft *B*.
Circle your answer.

[1 mark]

- 105 $^\circ$ 165 $^\circ$ 285 $^\circ$ 345 $^\circ$



14 The length of a rectangle is x cm
The width of the rectangle is 3 cm **less** than the length.

14 (a) Write down an expression for the width of the rectangle in terms of x . **[1 mark]**

Answer cm

***14 (b)** The perimeter of the rectangle is 40 cm
Set up and solve an equation to work out the length of the rectangle. **[4 marks]**

.....
.....
.....
.....
.....

Answer cm

Turn over for the next question



15 (a) The circumference of a circle is 25 cm

Work out the radius of the circle.

[2 marks]

.....
.....

Answer cm

15 (b) The diagram shows two identical circles joined together.

Each circle has a circumference of 32 cm

The dashed lines are one-quarter of each circumference.

Not drawn accurately

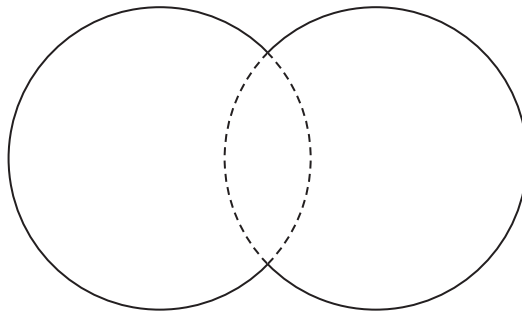

Work out the perimeter of the outer shape.



[3 marks]

.....
.....
.....
.....

Answer cm



- 16** The first diagram shows a kitchen wall with a window and two electric sockets.
The second diagram shows the length of each socket.

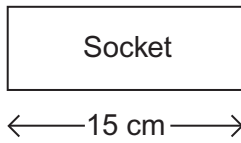
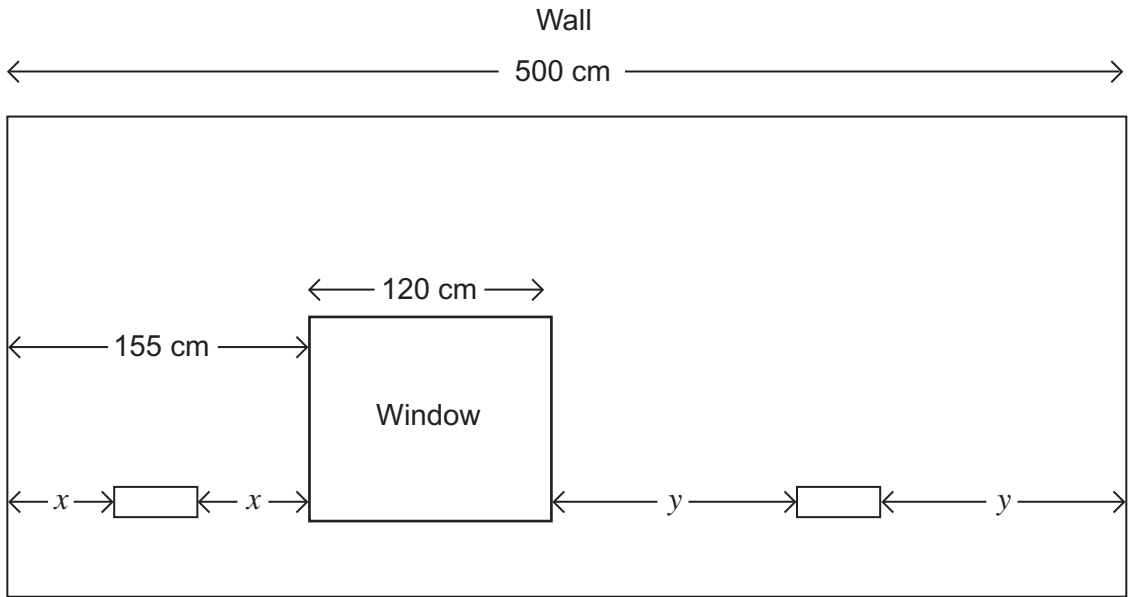

Not drawn accurately

Work out the lengths of x and y .

[5 marks]

.....

.....

.....

.....

.....

.....

.....

$x =$ cm

$y =$ cm

10

Turn over ►



17 The diagram shows an interior angle of a **regular** polygon.

Not drawn
accurately

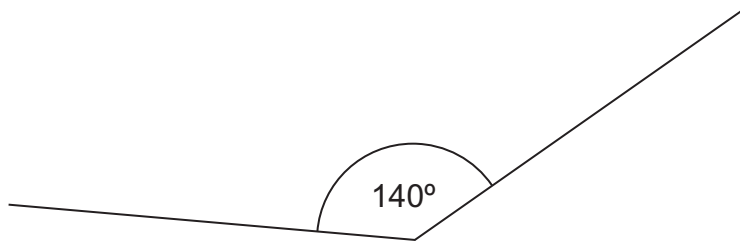

17 (a) Work out the size of an exterior angle of the polygon.

[1 mark]

.....

Answer degrees

17 (b) Work out the number of sides of the polygon.

[2 marks]

.....

.....

.....

Answer



18

Not drawn
accurately

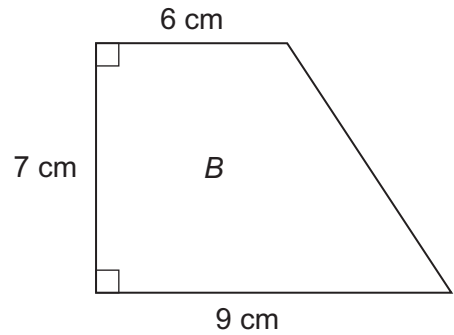
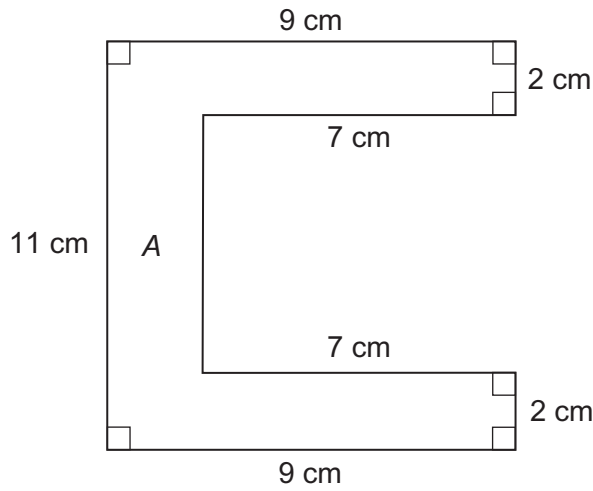

Which shape has the greater **area** and by how much?
You **must** show your working.

[5 marks]

.....

.....

.....

.....

.....

.....

.....

.....

.....

.....

Shape is greater by cm²

8

Turn over ►



***19** Use trial and improvement to find the solution to $x^3 = 6000$

Give your answer to 1 decimal place.

[4 marks]

x	x^3	Comment

$x = \dots\dots\dots$

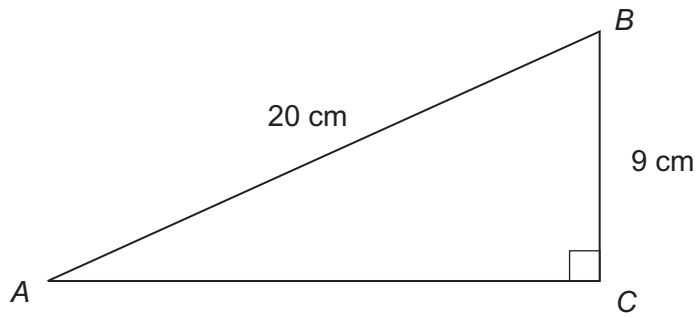

20

Not drawn
accurately

Work out the length AC .
Give your answer to 1 decimal place.

[4 marks]

.....

.....

.....

.....

Answer cm

END OF QUESTIONS

There are no questions printed on this page

**DO NOT WRITE ON THIS PAGE
ANSWER IN THE SPACES PROVIDED**

