

Centre Number						Candidate Number				
Surname										
Other Names										
Candidate Signature										

For Examiner's Use	
Examiner's Initials	
Pages	Mark
3	
4 – 5	
6 – 7	
8 – 9	
10 – 11	
12 – 13	
14 – 15	
16 – 17	
18 – 19	
20 – 21	
22 – 23	
TOTAL	



General Certificate of Secondary Education
Higher Tier
November 2012

Mathematics

43603H

Unit 3

Monday 12 November 2012 9.00 am to 10.30 am

H

<p>For this paper you must have:</p> <ul style="list-style-type: none"> • a calculator • mathematical instruments. 	
---	--

Time allowed

- 1 hour 30 minutes

Instructions

- Use black ink or black ball-point pen. Draw diagrams in pencil.
- Fill in the boxes at the top of this page.
- Answer **all** questions.
- You must answer the questions in the spaces provided. Do not write outside the box around each page or on blank pages.
- Do all rough work in this book.
- If your calculator does not have a π button, take the value of π to be 3.14 unless another value is given in the question.

Information

- The marks for questions are shown in brackets.
- The maximum mark for this paper is 80.
- The quality of your written communication is specifically assessed in Questions 3 and 16. These questions are indicated with an asterisk (*).
- You may ask for more answer paper, graph paper and tracing paper. These must be tagged securely to this answer booklet.

Advice

- In all calculations, show clearly how you work out your answer.



N 0 V 1 2 4 3 6 0 3 H 0 1

WMP/Nov12/43603H

43603H

Formulae Sheet: Higher Tier

$$\text{Area of trapezium} = \frac{1}{2}(a+b)h$$

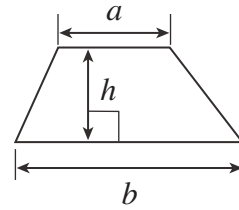

$$\text{Volume of prism} = \text{area of cross-section} \times \text{length}$$

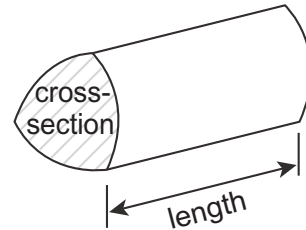

$$\text{Volume of sphere} = \frac{4}{3}\pi r^3$$

$$\text{Surface area of sphere} = 4\pi r^2$$

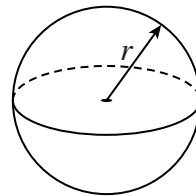

$$\text{Volume of cone} = \frac{1}{3}\pi r^2 h$$

$$\text{Curved surface area of cone} = \pi r l$$

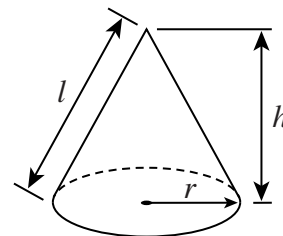

In any triangle ABC

$$\text{Area of triangle} = \frac{1}{2}ab \sin C$$

$$\text{Sine rule} \quad \frac{a}{\sin A} = \frac{b}{\sin B} = \frac{c}{\sin C}$$

$$\text{Cosine rule} \quad a^2 = b^2 + c^2 - 2bc \cos A$$

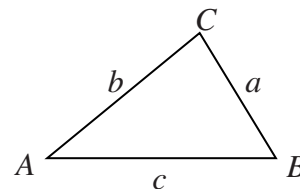

The Quadratic Equation

The solutions of $ax^2 + bx + c = 0$, where $a \neq 0$, are given by

$$x = \frac{-b \pm \sqrt{(b^2 - 4ac)}}{2a}$$



Answer **all** questions in the spaces provided.

1 A circle has radius 9.4 cm.

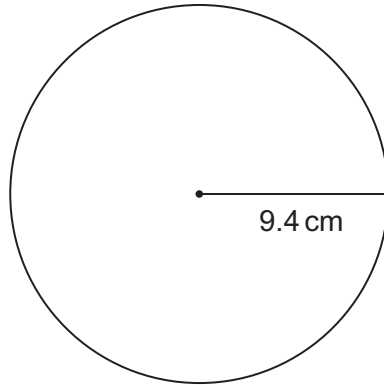

Not drawn accurately

1 (a) Work out the circumference of the circle.

.....

.....

Answer cm (2 marks)

1 (b) A semicircle has radius 9.4 cm.

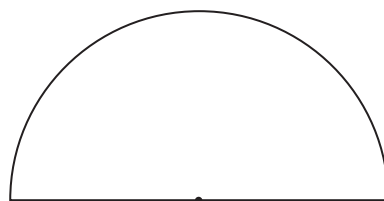

Not drawn accurately

Use your answer to part (a) to work out the perimeter of the semicircle.

.....

.....

Answer cm (2 marks)

4

Turn over ►



2 (a) Reflect the triangle in the line $x = 1$

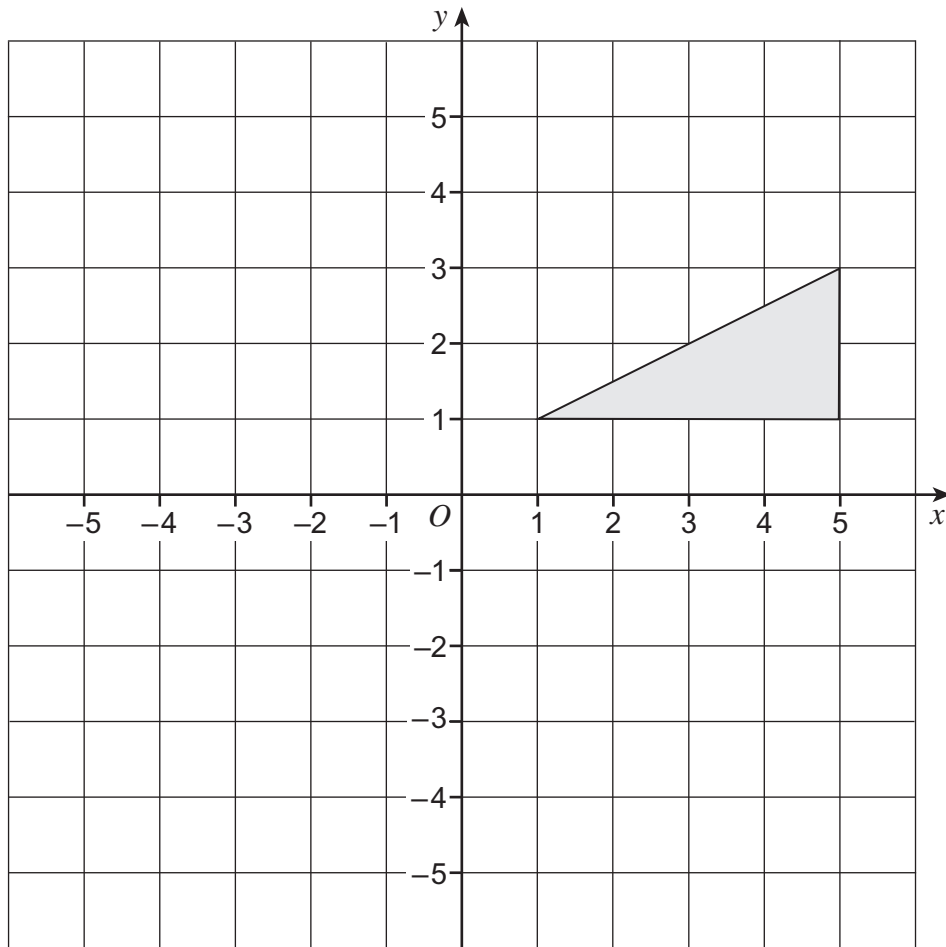

(2 marks)



2 (b) Rotate the triangle through 180° about the origin.

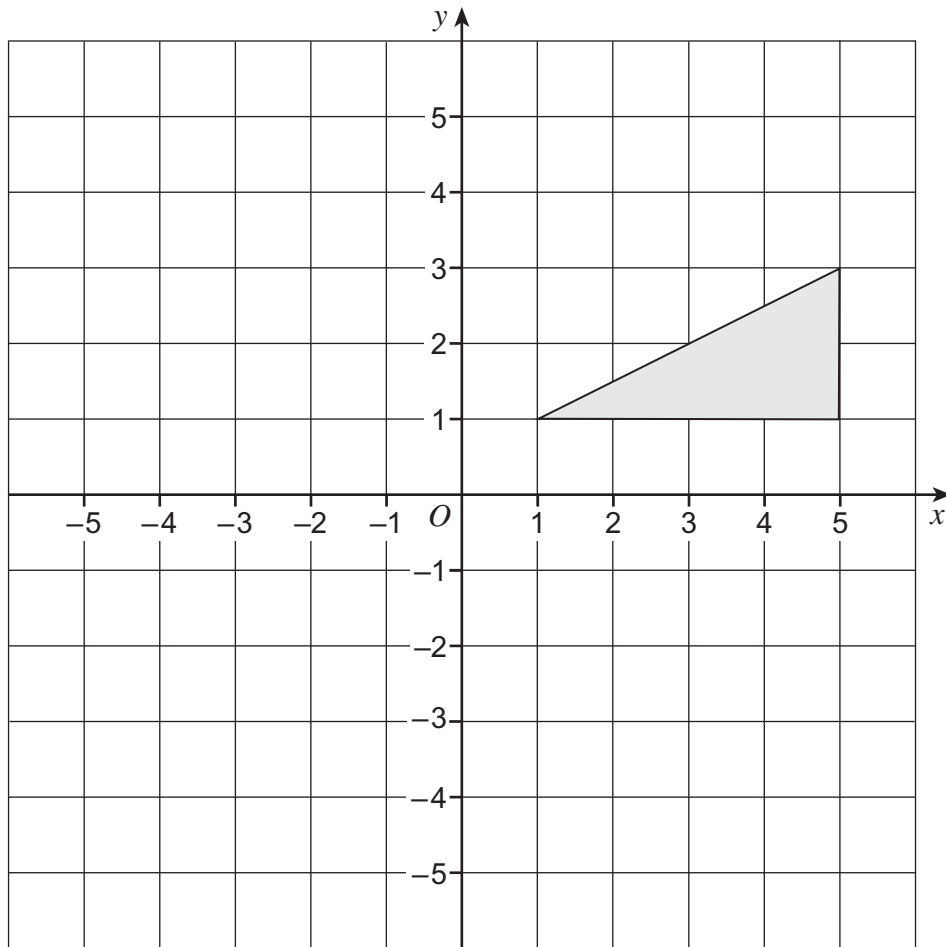

(2 marks)

Turn over for the next question



*3 The diagram shows two bottles of the same drink.

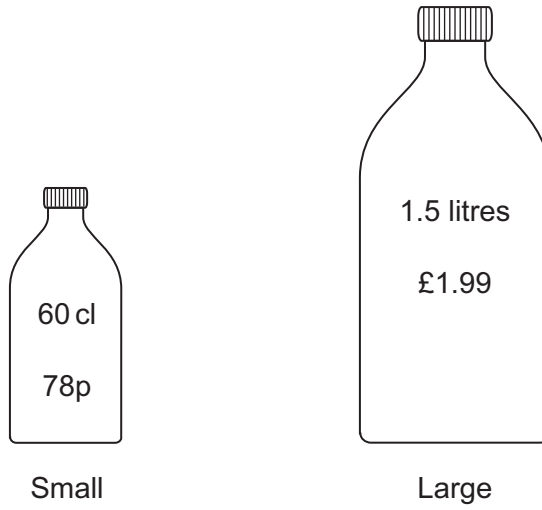

You are given that 1 litre = 100 cl

Which bottle is better value for money?
You **must** show your working.

.....

.....

.....

.....

.....

Answer (4 marks)



4 Here is a scale drawing of a play area.

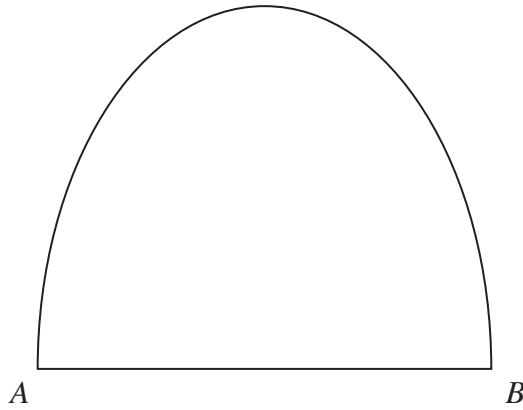

Scale 1 : 800

A straight wall is to be built from *A* to *B*.
250 bricks are needed for each metre of wall.

Work out the total number of bricks needed to build the wall.

.....

.....

.....

.....

.....

.....

.....

.....

.....

.....

.....

Answer (4 marks)



- 5 (a) The diagram shows a square piece of card.

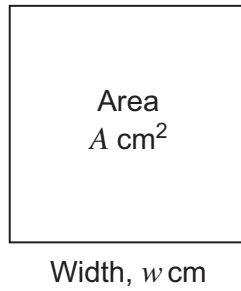

Write down a formula connecting A and w .

.....

Answer (1 mark)

- 5 (b) This diagram shows a cube.

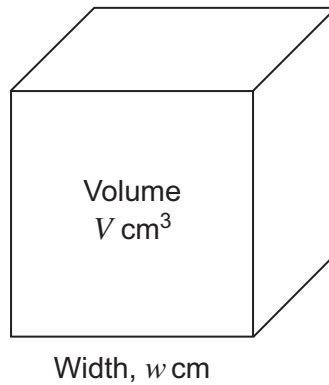

Write down a formula connecting V and w .

.....

Answer (1 mark)



5 (c) The area of one face of a cube is 20 cm^2 .

Work out the volume of the cube.

.....

.....

.....

Answer cm^3 (3 marks)

Turn over for the next question



6 (a) Three angles are in the ratio 2 : 3 : 7
The smallest angle is 60° .

Show that these three angles will fit together at a point with no gaps.

.....

.....

.....

.....

.....

(3 marks)

6 (b) Two angles form a straight line.
One of the angles is $(x + 30)$ degrees.

Write down an expression for the size of the other angle.
Give your answer in its simplest form.

.....

.....

Answer degrees (2 marks)



7 In the trapezium, $a = 6.5$ m, $b = 8.3$ m and $h = 3.2$ m

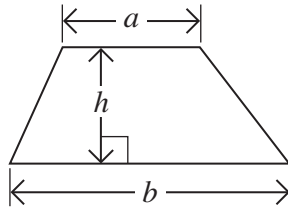

Not drawn accurately

The trapezium is the cross-section of a tunnel.
The tunnel is 200 metres long.

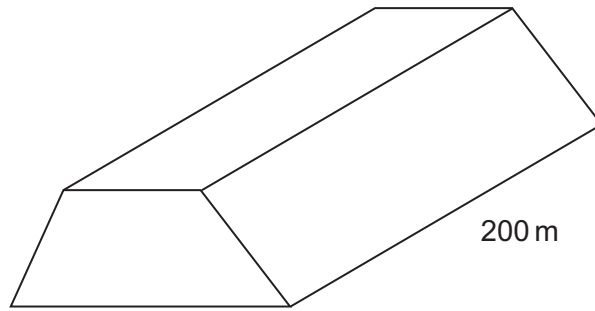

Work out the volume of the tunnel.

.....

.....

.....

.....

.....

.....

.....

.....

Answer m³ (4 marks)



8 Solve the equation $x^2 - 5 = 0$
Give your answers to 1 decimal place.

.....
.....

Answer and (2 marks)

9 The diagram shows a rectangle.

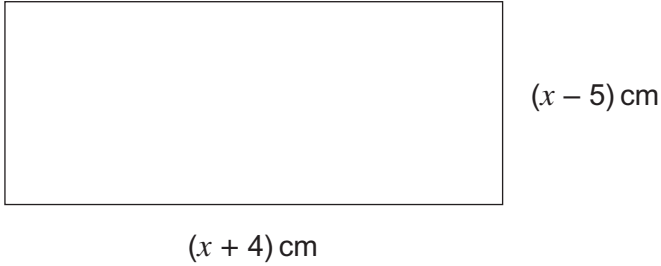

The area of the rectangle is 90 cm^2 .

Set up and solve a quadratic equation to work out the value of x .

.....
.....
.....
.....
.....

$x =$ cm (5 marks)



10 The diagram shows a cylinder of radius r cm and height $4r$ cm.

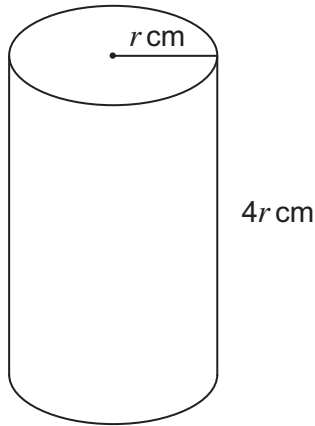

10 (a) Work out a formula for the volume, V of the cylinder in terms of π and r . Simplify your answer.

.....

.....

Answer (2 marks)

10 (b) Work out the volume of the cylinder when $r = 8$

.....

.....

.....

Answer cm^3 (2 marks)



11 This is a formula for the time to cook a turkey.

$$T = 15 + 20m$$

This is a formula for the time to cook a goose.

$$T = 40 + 15m$$

m is the mass in kilograms.

T is the time in minutes.

A turkey and a goose have the same mass and take the same time to cook.

Work out this time.

.....

.....

.....

.....

.....

.....

Answer minutes (4 marks)



12 (a) The diagram shows a right-angled triangle.

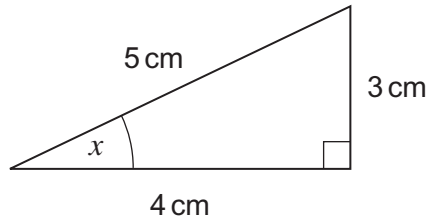

Not drawn
accurately

Write down the value of $\sin x$.

Answer (1 mark)

12 (b) In a different right-angled triangle, $\tan y = 0.7$

Work out the value of y .

Answer degrees (1 mark)

Turn over for the next question



- 13 (a) The diagram shows a rectangle.

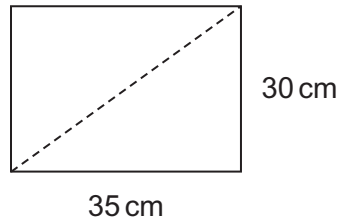

Not drawn accurately

Work out the length of the diagonal.

.....

.....

.....

Answer cm (3 marks)



13 (b) The rectangle in part (a) is the base of this box.
The box is a cuboid.

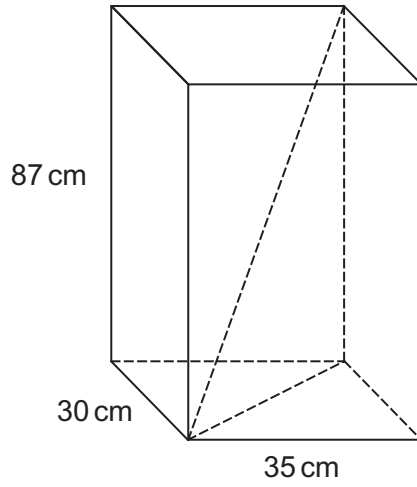

Will a straight rod of length 1 metre fit in the box?
You **must** show your working.

.....

.....

.....

.....

.....

.....

(3 marks)

Turn over for the next question



14 The diagram shows a circle, centre O .
 ATB is a tangent at T .

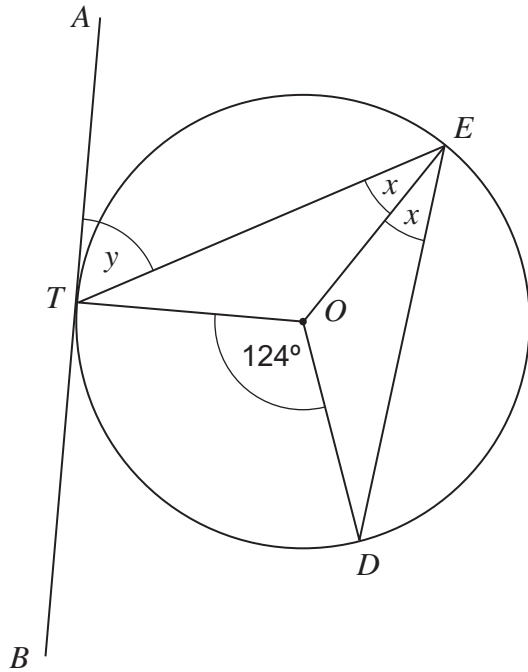

Not drawn
accurately

14 (a) Work out the value of x .

.....

.....

Answer degrees (2 marks)

14 (b) Work out the value of y .

.....

.....

.....

.....

Answer degrees (3 marks)



15 W is inversely proportional to x .
When $W = 6$, $x = 20$

Work out the value of W when $x = 24$

.....

.....

.....

.....

.....

.....

.....

Answer (4 marks)

Turn over for the next question



16 (a) You are given that 1 mile = 1.6 kilometres

Convert $6\frac{1}{2}$ miles into kilometres.

.....

.....

Answer km (2 marks)

*16 (b) A manufacturer claims a car like mine uses 5.5 litres per 100 km.

My car does 50 miles per gallon.

Is my car using more or less fuel than the manufacturer claims?
You **must** show your working.

.....

.....

.....

.....

.....

.....

.....

.....

.....

.....

.....

(5 marks)



- 17 $\vec{AB} = 2\mathbf{x}$ and $\vec{BC} = 4\mathbf{y}$
 ACD is a straight line.

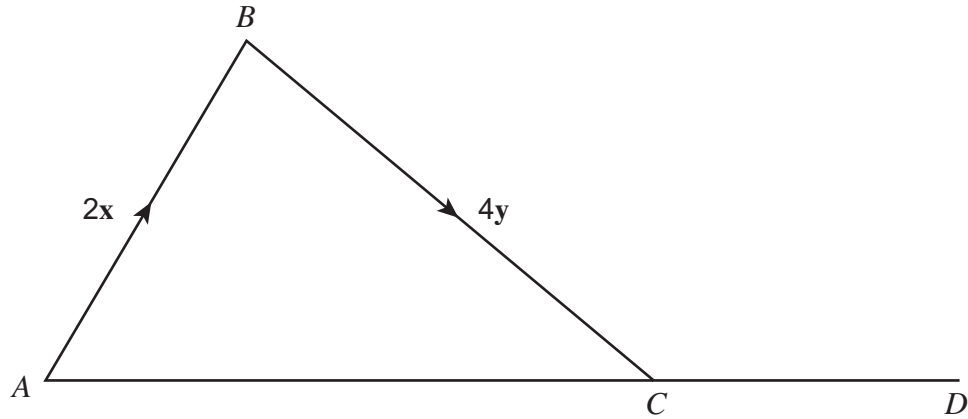

- 17 (a) Write down the vector \vec{AC} in terms of \mathbf{x} and \mathbf{y} .

Answer (1 mark)

- 17 (b) $AC : CD = 2 : 1$

Work out the vector \vec{AD} in terms of \mathbf{x} and \mathbf{y} .
 Give your answer as simply as possible.

.....

Answer (2 marks)

Turn over for the next question



18 (a) On the axes below sketch the graph of $y = x^3$

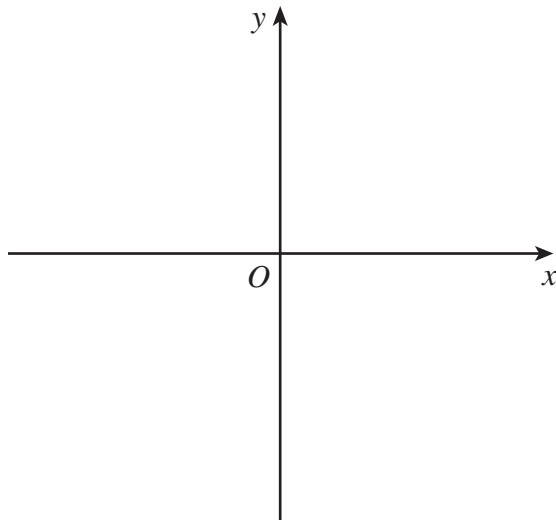

(1 mark)

18 (b) On the axes below sketch the graph of $y = x^3 + 8$

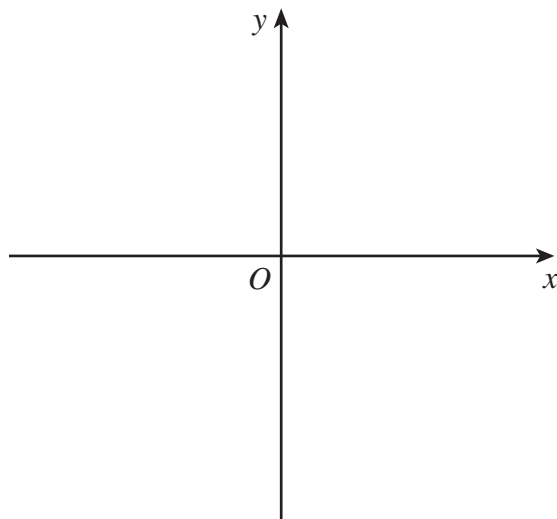

(1 mark)



19

ACD and BCE are straight lines.
Triangle ABC is similar to triangle DEC .
 AB is parallel to ED .

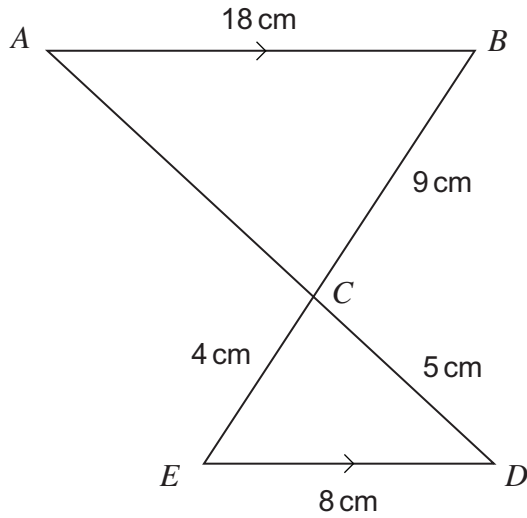

Not drawn
accurately

Work out the area of triangle ABC .

.....

.....

.....

.....

.....

.....

.....

.....

.....

.....

.....

.....

.....

.....

.....

.....

.....

.....

.....

.....

.....

.....

Answer cm^2 (6 marks)

END OF QUESTIONS



There are no questions printed on this page

**DO NOT WRITE ON THIS PAGE
ANSWER IN THE SPACES PROVIDED**

