

Centre No.							Paper Reference				Surname	Initial(s)			
Candidate No.							1	2	3	7	/	1	F	Signature	

Paper Reference(s)

1237/1F

Edexcel GCSE

Italian

Paper 1F – Listening and Responding

Foundation Tier

Monday 17 May 2010 – Morning

Time: 30 minutes (+5 minutes reading time)

Examiner’s use only

--	--	--

Team Leader’s use only

--	--	--

Question Number	Leave Blank
1-10	
11	
12	
13	
14	
15	
16-17	
18	
19	
Total	

Materials required for examination

Nil

Items included with question papers

Nil

Instructions to Candidates

In the boxes above, write your centre number, candidate number, your surname, initials and signature. Check that you have the correct question paper.

Answer ALL the questions. Write your answers in the spaces provided in this question paper.

Do not use pencil. Use blue or black ink.

Some questions must be answered with a cross in a box (☒). If you change your mind about an answer, put a line through the box (☒) and then mark your new answer with a cross (☒).

You must answer in the same language as the question. You need not write in complete sentences.

You will hear the extract twice. You may write whilst the tape is playing. Your teacher will pause the tape after the second playing of each extract to give you time to write your answer.

Turn over to the next page when you are told to do so.

Information for Candidates

You have 5 minutes to read through the paper before your teacher starts the tape.

You may NOT use a dictionary.

The marks for individual questions and the parts of questions are shown in round brackets: e.g. (2).

There are 19 questions in this question paper. The total mark for this paper is 50.

There are 12 pages in this question paper. Any blank pages are indicated.

Advice to Candidates

You are reminded of the importance of clear and orderly presentation in your answers.

This publication may be reproduced only in accordance with Edexcel Limited copyright policy.
©2010 Edexcel Limited.

Printer’s Log. No.
H36703A

W850/T1237/57570 1/1/1



Turn over



edexcel
advancing learning, changing lives

Gita in montagna

Ascolta questa conversazione tra Carolina e Marco.

Metti il segno (☒) nel posto giusto.

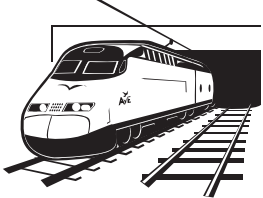
Esempio: Che cosa ha perso Chiara?

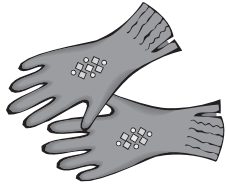
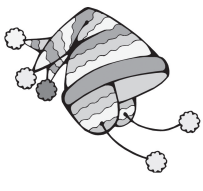

A 	B 	C 
☒	☒	☒

1. Che cosa ha dimenticato Marino?

A 	B 	C 
☒	☒	☒

(1)

2. Che cosa ha dimenticato Carolina?



A 	B 	C 
☒	☒	☒

(1)



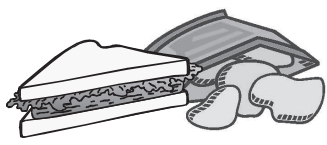

Leave blank

3. E Marco?

A 	B 	C 
<input type="checkbox"/>	<input type="checkbox"/>	<input type="checkbox"/>



(1)

4. Che cosa ha perso Luca?

A 	B 	C 
<input type="checkbox"/>	<input type="checkbox"/>	<input type="checkbox"/>



(1)

5. Che cosa si è rotto Andrea?

A 	B 	C 
<input type="checkbox"/>	<input type="checkbox"/>	<input type="checkbox"/>

(1)

6. Che cosa ha rotto Silvia?

A 	B 	C 
<input type="checkbox"/>	<input type="checkbox"/>	<input type="checkbox"/>



(1)



H 3 6 7 0 3 A 0 3 1 2

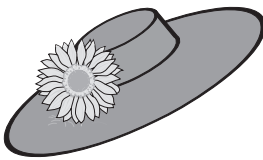

Leave blank

7. Che cosa ha trovato Francesco?

A 	B 	C 
<input type="checkbox"/>	<input type="checkbox"/>	<input type="checkbox"/>

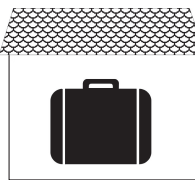

(1)

8. Dove l'ha portata?

A 	B 	C 
<input type="checkbox"/>	<input type="checkbox"/>	<input type="checkbox"/>

(1)

9. Che cosa ha ricevuto?

A 	B € 20	C 
<input type="checkbox"/>	<input type="checkbox"/>	<input type="checkbox"/>

(1)

10. Quanti soldi c'erano nella borsa?

A € 200	B € 300	C € 600
<input type="checkbox"/>	<input type="checkbox"/>	<input type="checkbox"/>

(1)

Q1-10









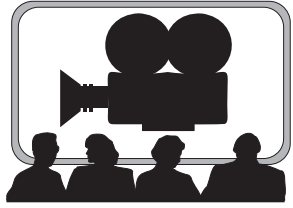
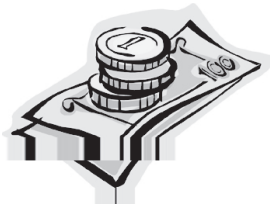

(Total 10 marks)

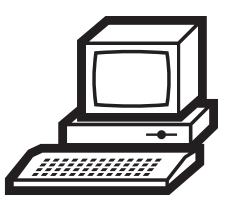

Regali di compleanno

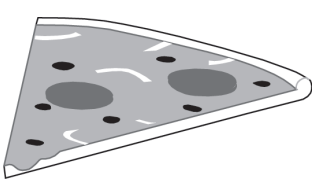
11. Ascolta questa conversazione.
Metti la lettera giusta nella casella.

ATTENZIONE! Per alcune persone ci sono due caselle.

A 	B 	C 
D 	E 	F 
G 	H 	I 
J 	K 	L 

Esempio	genitori	E	
(i)	nonni		
(ii)	zii		
(iii)	Giacomo		
(iv)	Rosalba		
(v)	amici		
(vi)	amico di papà		
(vii)	Lara		

(Total 10 marks)

Q11



Vacanza a Milano



12. Ascolta la conversazione.

Scrivi la lettera giusta accanto al giorno.

A	arrivo in albergo
B	visita della città
C	cattedrale e castello
D	shopping
E	teatro
F	fiera
G	museo
H	ritorno

Esempio	Lunedì	A
(i)	Martedì	
(ii)	Mercoledì	
(iii)	Giovedì	
(iv)	Venerdì	
(v)	Venerdì sera	
(vi)	Sabato	

Q12

(Total 6 marks)



Leave
blank

Partner per lo scambio

13. Ascolta queste conversazioni.

Inserisci le informazioni nella tabella:

cane	centro	campagna
gatti	mare	fratello

Nome	Dove abita	Fratelli/Sorelle	Animali
Isa	periferia	nessuno	(i)
Giorgio	(ii)	(iii)	no
Teresa	(iv)	sorella	(v)

Q13

(Total 5 marks)

7



Turn over

Leave
blank

Ragazzi

14. Ascolta queste conversazioni.

Metti un segno (☒) nella casella giusta.

		Fabrizio	Vincenzo	Luciano	Gianni	Dario
Esempio	Pensa di essere il più intelligente	<input checked="" type="checkbox"/>	<input type="checkbox"/>	<input type="checkbox"/>	<input type="checkbox"/>	<input type="checkbox"/>
(a)	Porta vestiti fuori moda	<input type="checkbox"/>	<input type="checkbox"/>	<input type="checkbox"/>	<input type="checkbox"/>	<input type="checkbox"/>
(b)	È molto carino	<input type="checkbox"/>	<input type="checkbox"/>	<input type="checkbox"/>	<input type="checkbox"/>	<input type="checkbox"/>
(c)	Non ha buone maniere	<input type="checkbox"/>	<input type="checkbox"/>	<input type="checkbox"/>	<input type="checkbox"/>	<input type="checkbox"/>
(d)	È pigro	<input type="checkbox"/>	<input type="checkbox"/>	<input type="checkbox"/>	<input type="checkbox"/>	<input type="checkbox"/>

Q14

(Total 4 marks)



Al ristorante

15. Ascolta questa conversazione.

Completa la scheda **in italiano**.

Esempio	Da bere:vino..... bianco.
(a)	Antipasto: e melone.
(b)	Primo piatto: ai funghi.
(c)	Secondo: alla fiorentina.
(d)	Contorno: al forno.
(e)	Dolce: torta di

Leave
blank

Q15

(Total 5 marks)



Leave
blank

The new sports centre

16. You collect information about a new sports centre for your English friend who is staying with you in Italy.

(a) When will the Sports Centre be opening?

.....
(1)

(b) Name **two** of the facilities it offers.

.....
.....
(2)

(Total 3 marks)

Q16

17. (a) How much does an ordinary entrance ticket cost?

.....
(1)

(b) What reduction do students get?

.....
(1)

(Total 2 marks)

Q17



Leave
blank

The brown bear

18. Your English friend likes animals. You hear this report and make notes for him.



(a) What are we told about the brown bear's diet?

..... (1)

(b) At which time of year does he eat the most?

..... (1)

(c) How much food can he get through in one day?

..... (1)

(Total 3 marks)

Q18

19. (a) When is he most active?

..... (1)

(b) Who is said to be his worst enemy?

..... (1)

(Total 2 marks)

Q19

TOTAL FOR PAPER: 50 MARKS

END



BLANK PAGE

