

IM HAUSHALT



Was ist neu in Ralfs Haus?

Kreuze die richtige Antwort an (☒).



Beispiel:

A 	B 	C 
<input checked="" type="checkbox"/>	<input type="checkbox"/>	<input type="checkbox"/>

1.

A 	B 	C 
<input type="checkbox"/>	<input type="checkbox"/>	<input type="checkbox"/>

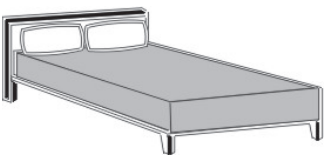
2.

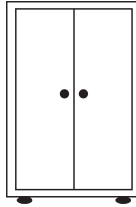
A 	B 	C 
<input type="checkbox"/>	<input type="checkbox"/>	<input type="checkbox"/>

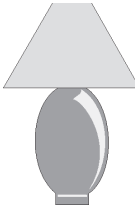
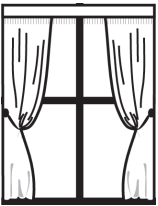
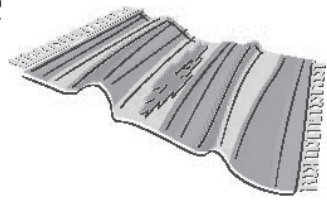

3.

A 	B 	C 
<input type="checkbox"/>	<input type="checkbox"/>	<input type="checkbox"/>





Leave blank

4.

A 	B 	C 
<input type="checkbox"/>	<input type="checkbox"/>	<input type="checkbox"/>

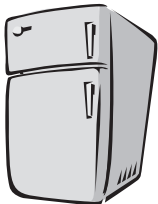
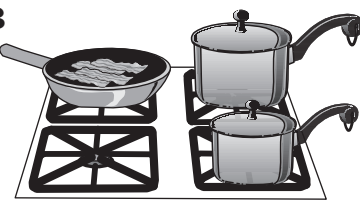
5.

A 	B 	C 
<input type="checkbox"/>	<input type="checkbox"/>	<input type="checkbox"/>

(Total 5 marks)

Q1-5









A 2 5 3 2 1 A 0 3 1 6

Leave blank

FREIZEIT

Was machen sie gern in der Freizeit?

Kreuze an (☒).

	A 	B 	C 	D 	E 	F 	G 
Beispiel Sebastian	<input type="checkbox"/>	<input type="checkbox"/>	<input type="checkbox"/>	<input type="checkbox"/>	<input type="checkbox"/>	<input type="checkbox"/>	<input checked="" type="checkbox"/>
6. Steffi	<input type="checkbox"/>	<input type="checkbox"/>	<input type="checkbox"/>	<input type="checkbox"/>	<input type="checkbox"/>	<input type="checkbox"/>	<input type="checkbox"/>
7. Tobias	<input type="checkbox"/>	<input type="checkbox"/>	<input type="checkbox"/>	<input type="checkbox"/>	<input type="checkbox"/>	<input type="checkbox"/>	<input type="checkbox"/>
8. Laura	<input type="checkbox"/>	<input type="checkbox"/>	<input type="checkbox"/>	<input type="checkbox"/>	<input type="checkbox"/>	<input type="checkbox"/>	<input type="checkbox"/>
9. Dieter	<input type="checkbox"/>	<input type="checkbox"/>	<input type="checkbox"/>	<input type="checkbox"/>	<input type="checkbox"/>	<input type="checkbox"/>	<input type="checkbox"/>
10. Hanna	<input type="checkbox"/>	<input type="checkbox"/>	<input type="checkbox"/>	<input type="checkbox"/>	<input type="checkbox"/>	<input type="checkbox"/>	<input type="checkbox"/>

(Total 5 marks)

Q6-10



SCHULFÄCHER

Leave blank

Was lernen sie gern in der Schule?

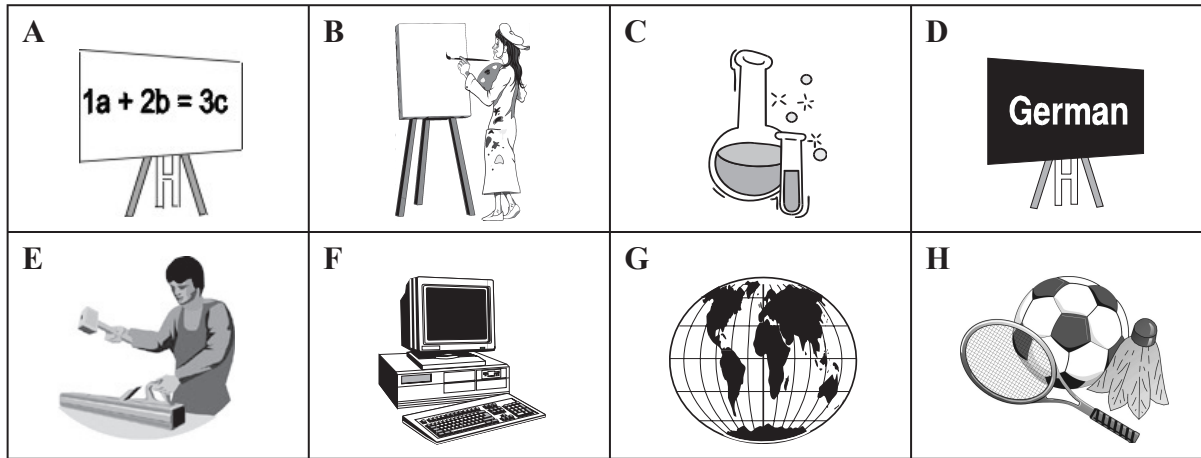

Trage den richtigen Buchstaben ein.

<p>Beispiel Kurt</p>	<p>D</p>
<p>11. Doris</p>	
<p>12. Boris</p>	
<p>13. Pia</p>	
<p>14. Ali</p>	
<p>15. Angela</p>	

(Total 5 marks)

Q11-15



MEDIEN

16. Franziska, Hendrick und Aisha reden über die Medien.

Wer sagt was? Kreuze entweder **Franziska**, **Hendrick** oder **Aisha** an (☒).

	Franziska	Hendrick	Aisha
Beispiel Ich mag Radio.	☒	☒	☒
(a) Ich sehe viel Sport.	☒	☒	☒
(b) Ich relaxe vor dem Fernseher.	☒	☒	☒
(c) Ich lese beim Musikhören.	☒	☒	☒
(d) Ich finde Musik im Fernsehen klasse.	☒	☒	☒
(e) Ich mag Radio gar nicht.	☒	☒	☒

(Total 5 marks)

Q16



SPORT

Leave blank

17. Welche Sportarten treiben Jens und seine Schwester?

Kreuze die 5 richtigen Kästchen an (☒).

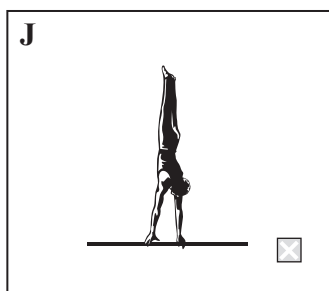
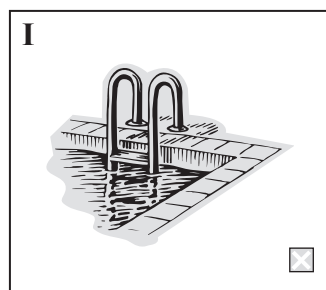
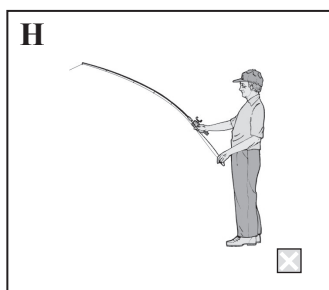
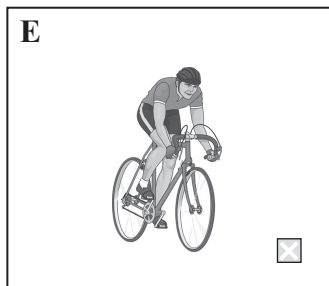
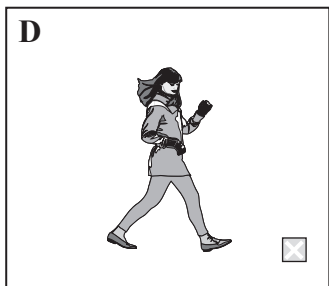
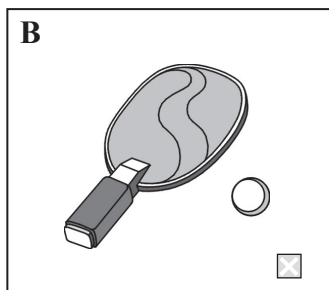
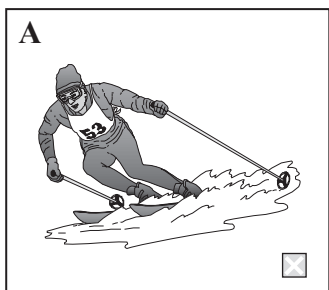

(Total 5 marks)

Q17

7

Turn over



JOB

Leave
blank

18. Martin hat einen neuen Job.

Fülle die Tabelle auf **Deutsch** aus.

Beispiel

Wo? **Restaurant**

(a) Job

(b) Erster Arbeitstag

(c) Uniform

(i)

(ii)

(d) Euro pro Stunde

Q18

(Total 5 marks)



Leave
blank

EIN NEUES HAUS

19. Ali, Uta und Max besprechen ihr Zuhause.

Wer ist das? Trage entweder **Ali**, **Uta** oder **Max** ein.

Beispiel:

..... **Ali** findet sein Haus wunderbar.

(a) findet das neue Haus zu klein.

(b) wohnt nicht mehr in der Stadt.

(c) findet das Leben in der Stadt uninteressant.

(d) hat jetzt ein eigenes Schlafzimmer.

(e) hat ein bequemes Haus.

Q19

(Total 5 marks)



URLAUB

Ute beschreibt ihren Urlaub.



Kreuze die richtige Antwort an (☒).

Beispiel:

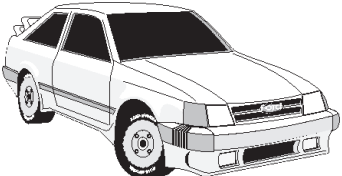
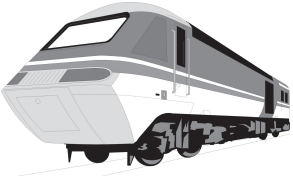

Wie ist Ute nach Sylt gefahren?

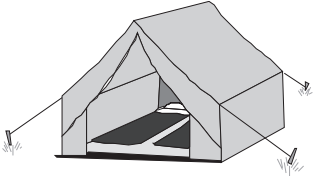
<p>A</p> 	<p>B</p> 	<p>C</p> 
<p style="text-align: center;">☒</p>	<p style="text-align: center;">☒</p>	<p style="text-align: center;">☒</p>

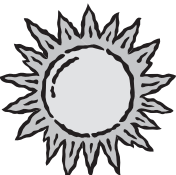

20. Wo hat sie auf Sylt gewohnt?

<p>A</p> 	<p>B</p> 	<p>C</p> 
<p style="text-align: center;">☒</p>	<p style="text-align: center;">☒</p>	<p style="text-align: center;">☒</p>

21. Wie war das Wetter normalerweise?

<p>A</p> 	<p>B</p> 	<p>C</p> 
<p style="text-align: center;">☒</p>	<p style="text-align: center;">☒</p>	<p style="text-align: center;">☒</p>

22. Was hat sie auf Sylt gemacht?

<p>A</p> 	<p>B</p> 	<p>C</p> 
<p style="text-align: center;">☒</p>	<p style="text-align: center;">☒</p>	<p style="text-align: center;">☒</p>



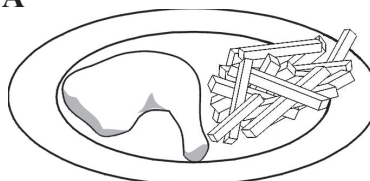
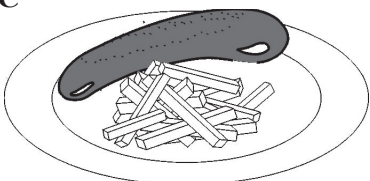

Leave blank

23. Was war ihr Lieblingsessen?

A 	B 	C 
<input type="checkbox"/>	<input type="checkbox"/>	<input type="checkbox"/>

24. Was hat sie als Souvenir gekauft?

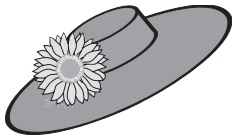
A 	B 	C 
<input type="checkbox"/>	<input type="checkbox"/>	<input type="checkbox"/>

Q20-24

(Total 5 marks)



Leave
blank

MICHAEL BALLACK

25. You hear a radio interview with Michael Ballack.

Make notes to show your PE teacher.

Answer the following questions **in English**.

(a) When was Michael Ballack born?

..... (1)

(b) What does he say about his school days? Give **one** detail.

..... (1)

(c) What do we learn about his family?

..... (1)

(d) What does he enjoy about his work? Give **two** details.

(i) (1)

(ii) (1)

(Total 5 marks)

Q25



Leave
blank

TOURIST INFORMATION

26. Alex is in the tourist information office in Salzburg enquiring about accommodation.

Make notes for your coursework project.

Answer the following questions **in English**.

(a) What sort of room does Alex require?

..... (1)

(b) For when?

..... (1)

(c) Why is the Stern Hotel recommended? Give **one** detail.

..... (1)

(d) Where is the hotel located?

..... (1)

(e) What else does Alex ask?

..... (1)

Q26

(Total 5 marks)

TOTAL FOR PAPER: 50 MARKS

END



BLANK PAGE



BLANK PAGE



BLANK PAGE

