



Rewarding Learning

General Certificate of Secondary Education
2015

Centre Number

--	--	--	--	--

Candidate Number

--	--	--	--

French

Unit 3: Listening
Foundation Tier

MV18

[GFR31]

TUESDAY 12 MAY, MORNING

TIME

35 minutes (including 5 minutes reading time), plus your additional time allowance.

INSTRUCTIONS TO CANDIDATES

Write your Centre Number and Candidate Number in the spaces provided at the top of this page.

You must answer the questions in the spaces provided.

Complete in blue or black ink only.

Answer **all thirteen** questions.

You will have 5 minutes to read through the paper after the CD starts.

INFORMATION FOR CANDIDATES

The total mark for this paper is 40.

Figures in brackets printed at the end of each question indicate the marks awarded to each question or part question.

Use of a dictionary is **not** permitted.

BLANK PAGE

Answer **all** questions.

1 Fabien talks about his English friend.

Complete the answers **in English**.

(a) Paul is _____ years old. [1 mark]

(b) He is very _____. [1 mark]

(c) He loves _____. [1 mark]

(d) His father is a _____. [1 mark]

2 You hear this conversation in a bakery.

Tick (✓) the correct box.

(a) The customer asks for [1 mark]

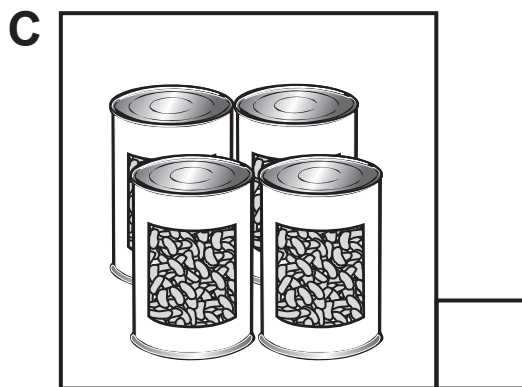
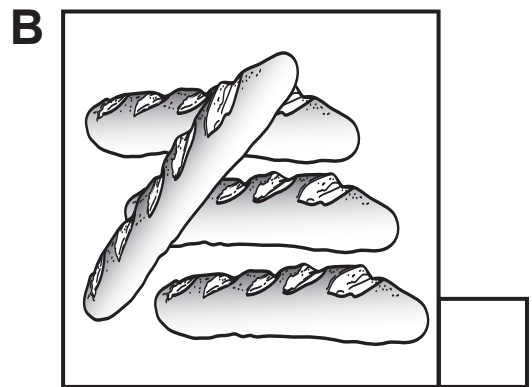
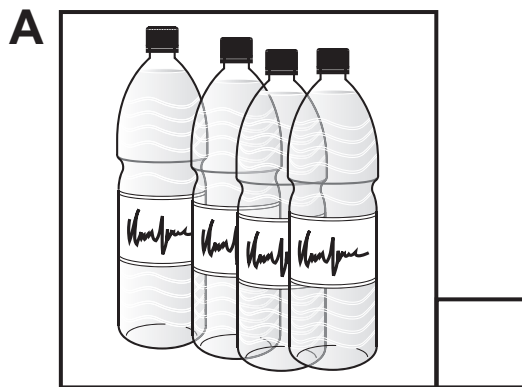

(b) The cost is [1 mark]

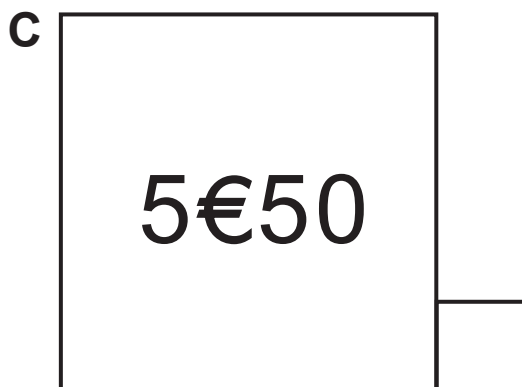
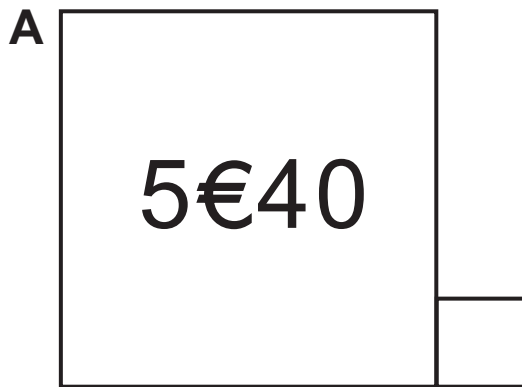

3 Your friend talks about her garden.

Complete the answers **in English**.

(a) Jeanne's mother loves _____ . [1 mark]

(b) Her father grows lovely _____ . [1 mark]

4 Four children talk about items they have received for the start of the school year.

Tick (✓) the correct box.

(a) Philippe has received [1 mark]

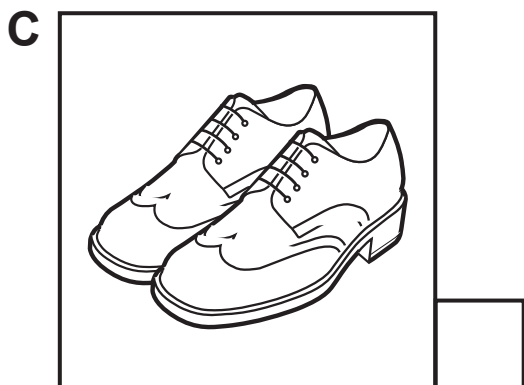
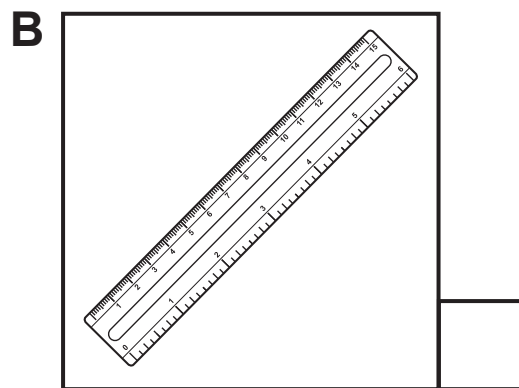
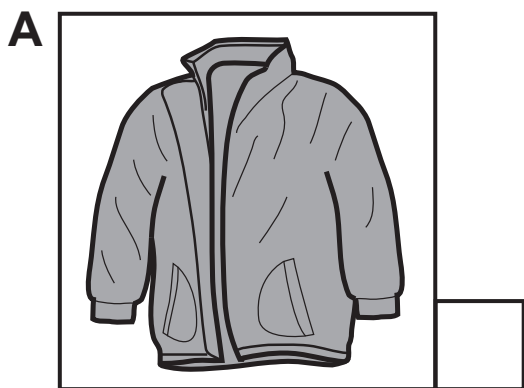

(b) Anne has received [1 mark]

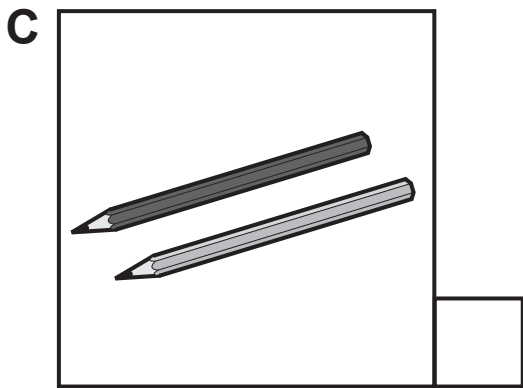
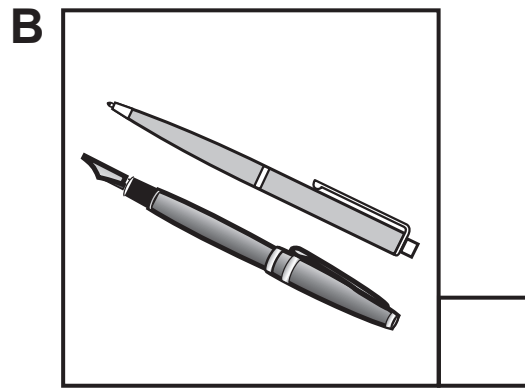
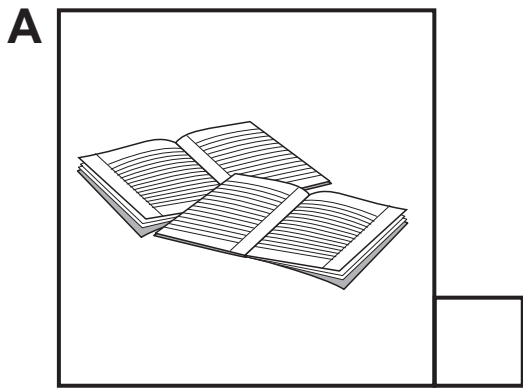

(c) Sylvain has received [1 mark]

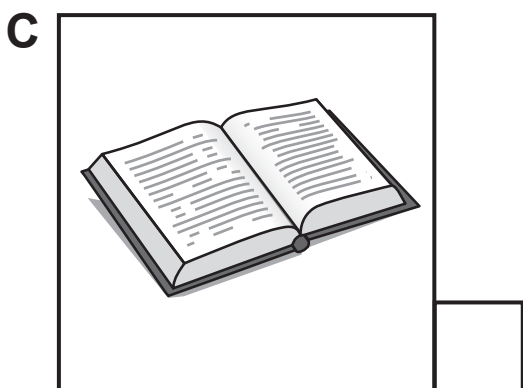
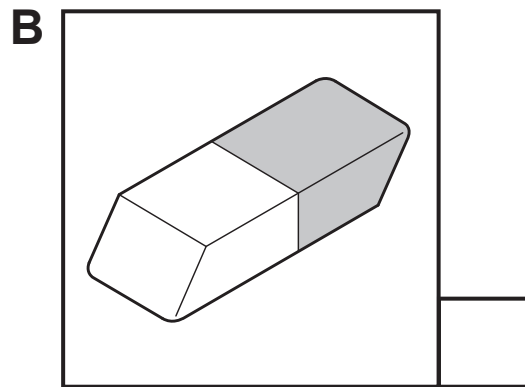
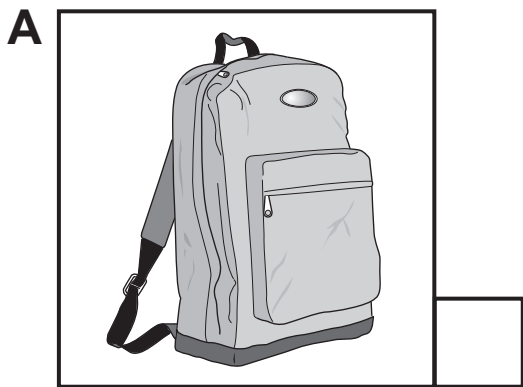

(d) Estelle has received [1 mark]

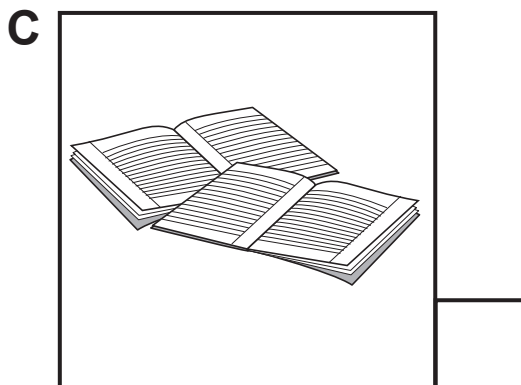
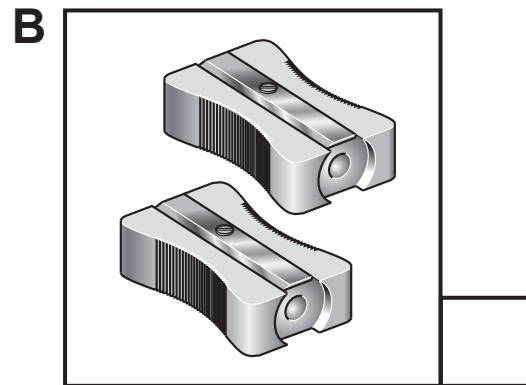
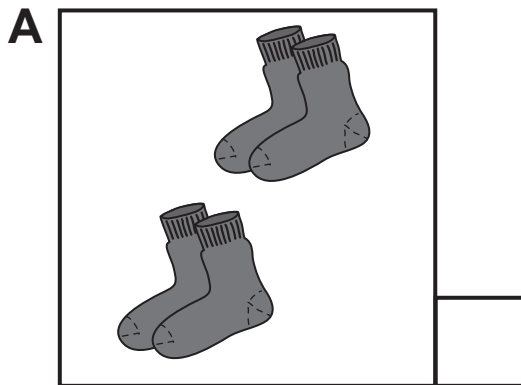

5 You hear this announcement about household goods.

Complete the answers in **English**.

(a) There is a reduction of 25% on _____ .
[1 mark]

(b) The offer only lasts for _____ .
[1 mark]

6 Karima talks about her favourite tee-shirts.

Tick (✓) the correct box.

(a) Karima prefers pictures of [1 mark]

A sports stars.

B pop stars.

C film stars.

(b) Her brother prefers pictures of [1 mark]

A wild animals.

B pets.

C singers.

7 You hear a man selling things at a market.

Tick (✓) the **two** correct boxes. [2 marks]

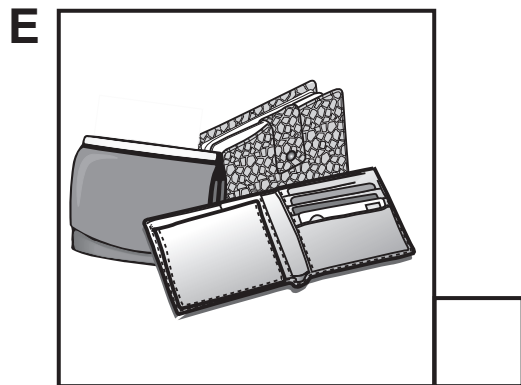
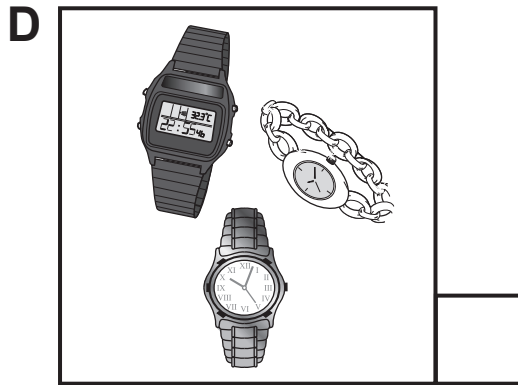
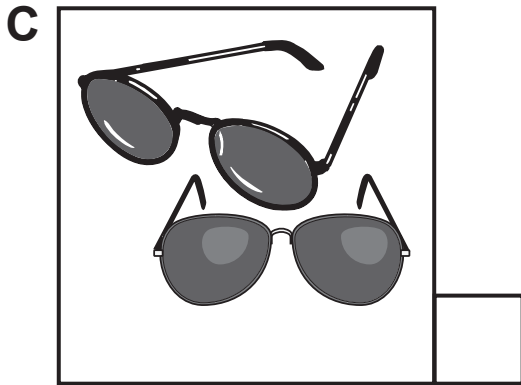
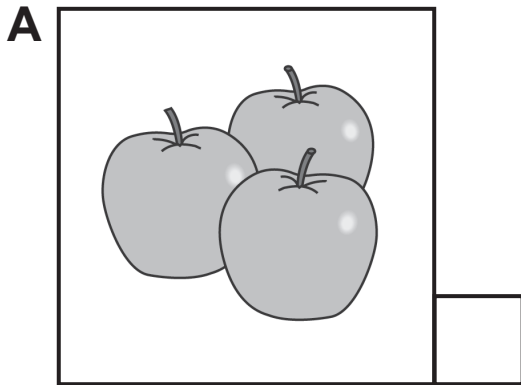

8 You hear this advert for Ireland on French television.

Complete the answers in **English**.

(a) It does not rain _____ . [1 mark]

(b) You will admire the _____
countryside. [1 mark]

(c) You will have a good time if you like
_____ . [1 mark]

(d) There are _____ flights from Paris.
[1 mark]

9 You hear two teenagers discussing what they would like as birthday presents.

Tick (✓) the correct box.

(a) Françoise likes [1 mark]

A opening her presents.

B surprises.

C choosing her own presents.

(b) Jacques [1 mark]

A finds it easy to choose a present.

B has a lot of things in his room.

C would like a new phone.

10 Four people talk about their favourite pastimes.

Write the correct letter beside the name of the person.

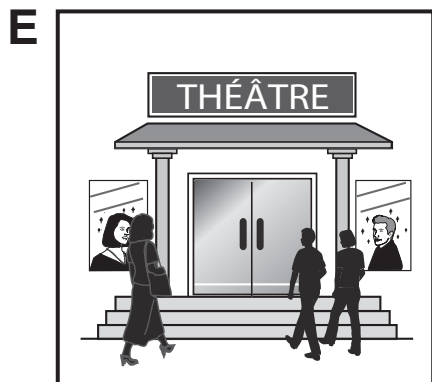
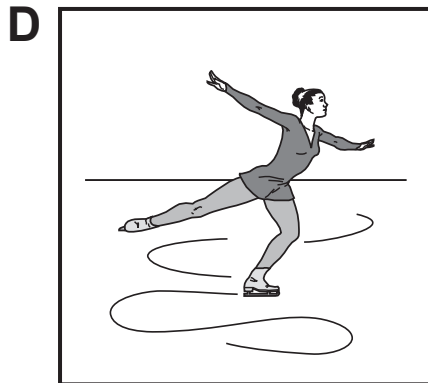
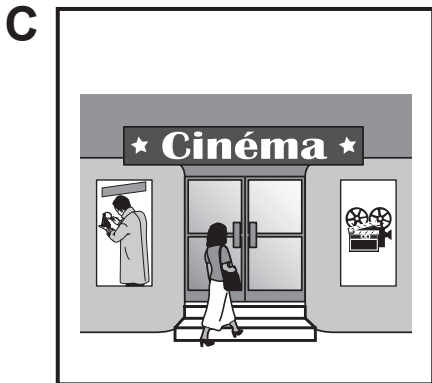
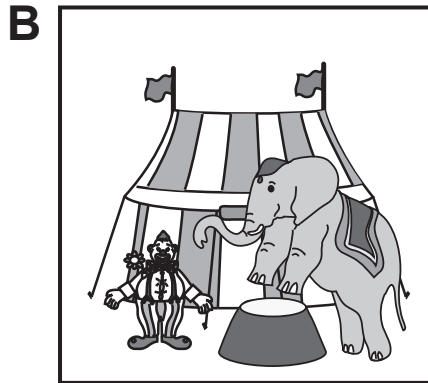
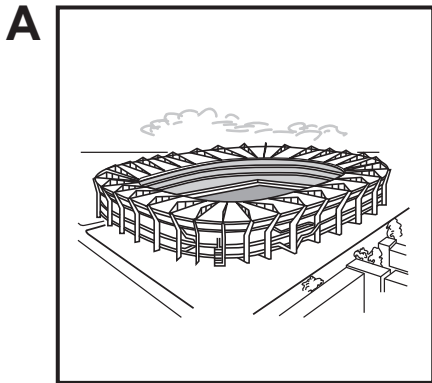

(a) Corinne _____ [1 mark]

(b) Yannick _____ [1 mark]

(c) Monique _____ [1 mark]

(d) Serge _____ [1 mark]

11 You hear these announcements in a village in the south of France.

Complete the answers **in English**.

(a) The announcements are for tourists on their _____ holidays. [1 mark]

(b) There is a horse _____ each year. [1 mark]

(c) The film is called “My father does the _____”. [1 mark]

(d) The number to ring is 04 22 58 35 _____. [1 mark]

12 Four students talk about the changes they would like to make in schools.

Tick (✓) the correct box.

(a) Sandrine would like to change [1 mark]

A all the teachers.

B some of the teachers.

C one of the teachers.

(b) Christophe would like [1 mark]

A longer Christmas holidays.

B shorter Hallowe'en holidays.

C longer summer holidays.

(c) Catherine thought that the English pupils [1 mark]

A did not like their uniform.

B were jealous of each other.

C liked their uniform.

(d) Aurélien thinks that French pupils [1 mark]

A do not study enough subjects.

B study too many subjects.

C are too relaxed about their studies

13 Two students talk about their holiday destinations.

Write your answers **in English** in the boxes.

(a) Robert likes the mountains because [2 marks]

Reason 1	Reason 2

(b) Amélie likes the seaside because [2 marks]

Reason 1	Reason 2

THIS IS THE END OF THE QUESTION PAPER

For Examiner's use only

Question Number	Marks
1	
2	
3	
4	
5	
6	
7	
8	
9	
10	
11	
12	
13	

Total Marks	
--------------------	--

Examiner Number

Permission to reproduce all copyright material has been applied for. In some cases, efforts to contact copyright holders may have been unsuccessful and CCEA will be happy to rectify any omissions of acknowledgement in future if notified.