

Candidate Name	Centre Number	Candidate Number



OXFORD CAMBRIDGE AND RSA EXAMINATIONS
General Certificate of Secondary Education

DESIGN AND TECHNOLOGY
(SYSTEMS AND CONTROL TECHNOLOGY)

PAPER 3: ELECTRONICS
 FOUNDATION TIER

1957/3
1953/1
1053/1

Specimen Paper 2003

Additional materials: Formulae Sheet OCR (Tables 2).

TIME 1 hour

INSTRUCTIONS TO CANDIDATES

Write your name, Centre number and candidate number in the boxes above.

Answer **all** questions.

Write your answers, in blue or black ink, in the spaces provided on the question paper.

Read each question carefully and make sure you know what you have to do before starting your answer.

Show all your working out for calculations.

INFORMATION FOR CANDIDATES

The number of marks is given in brackets [] at the end of each question or part question.

Marks will be awarded for the use of correct conventions.

Dimensions are in millimetres unless stated otherwise.

Total marks for this paper is **50**.

Question Number	For Examiner's use only
1	
2	
3	
4	
5	
TOTAL	

- 1 Fig. 1 shows a photographic darkroom with an enlarger and light meter, items that are used when printing photographs.

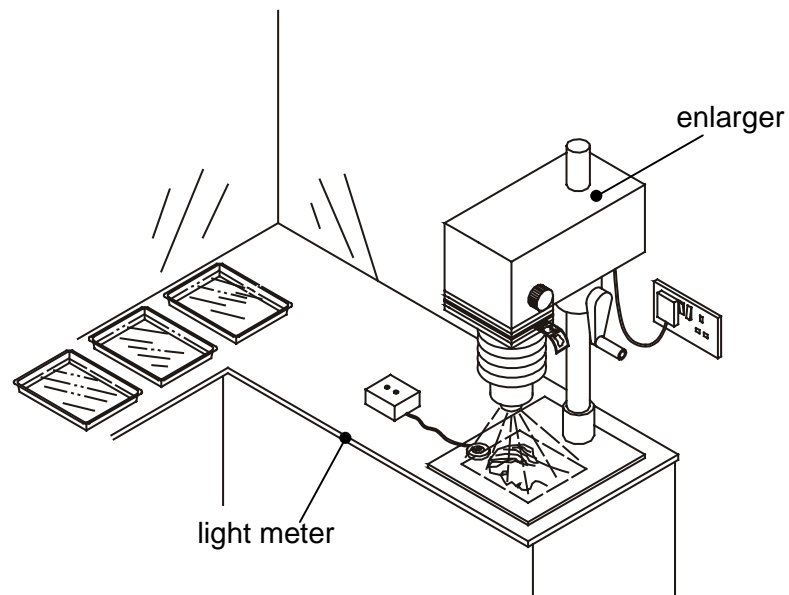

Fig. 1

- (a) (i) Five components from the light meter are shown in Fig. 2.

When constructing the circuit for the light meter the components have to be matched to circuit symbols on the printed circuit board.

Complete the table below by matching components to circuit symbols. The first one has been done for you.

A	

Fig. 2

[4]

- (ii) State which component has a resistance that changes.

[1]

- (b) (i) Materials used for the connections on components must be good electrical conductors.

From the list below state **three** materials that are good electrical conductors.

Polystyrene

Ceramic

Gold

GRP (Glass Reinforced Plastic)

Tin

Brass

1 _____ 2 _____ 3 _____ [3]

- (ii) Explain why untreated mild steel is **not** used as an electrical conductor in components.

_____ [2]

- 2 A printed circuit board (PCB) for the light meter has a suspected break in one of the PCB tracks. Fig. 3 shows the probes of a multimeter being used to test the PCB.

The multimeter can be set to measure **current**, **resistance** or **voltage**.

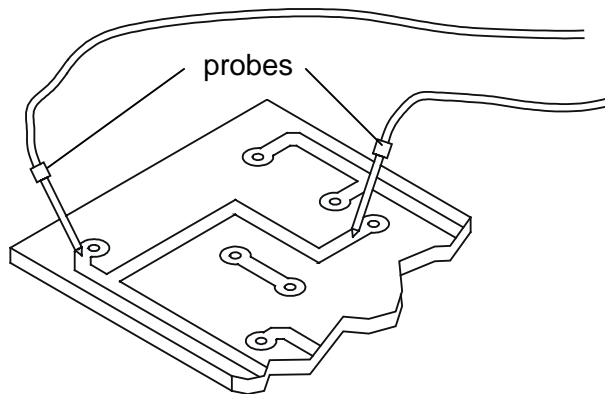

Fig. 3

- (a) (i) State the most suitable setting for the multimeter to test the PCB before components are added.

[1]

- (ii) With the probes as shown in Fig. 3 and the multimeter set to the most suitable range, the reading is **0.00**

Explain what this means.

[2]

- (b) (i) Using the components in Fig. 4 draw a circuit diagram for a low cost alternative to the multimeter for carrying out tests on PCB tracks.

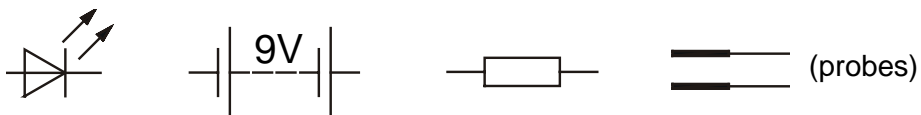

Fig. 4

[4]

- (ii) Explain the purpose of the resistor in the circuit.

[2]

- (iii) From the resistor values given below, circle the one that will make the circuit work.

22R 470R 5k6 10k

[1]

- 3 A car accessory manufacturer is developing a circuit to warn drivers when the outside temperature drops below freezing. The sensor for the circuit is an NTC thermistor.

Fig. 5 shows the circuit and thermistor specification.

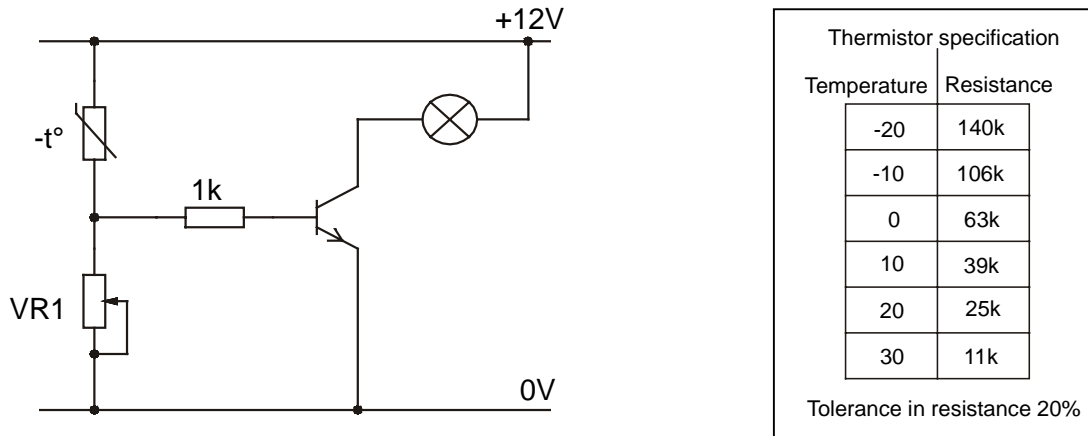

Fig. 5

- (a) (i) Explain why the variable resistor **VR1** is used in the circuit rather than a fixed resistor.

[2]

- (ii) The thermistor has a tolerance of $\pm 20\%$.

State the range of values that could be expected at 10°C .

[2]

- (iii) When the circuit is built on a breadboard the current flow through the thermistor is measured with a multimeter. Fig. 6 shows the reading taken.

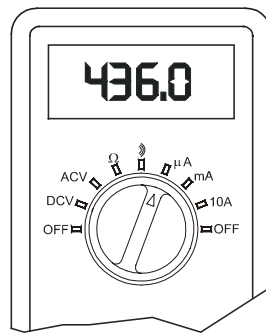

Fig. 6

Give the same current flow in milliamps.

[1]

- (iv) When the circuit was tested the warning light was normally **on** and went **off** as the temperature dropped.

Draw a simple modification using no extra components which would cause the light to come **on** as the temperature dropped.

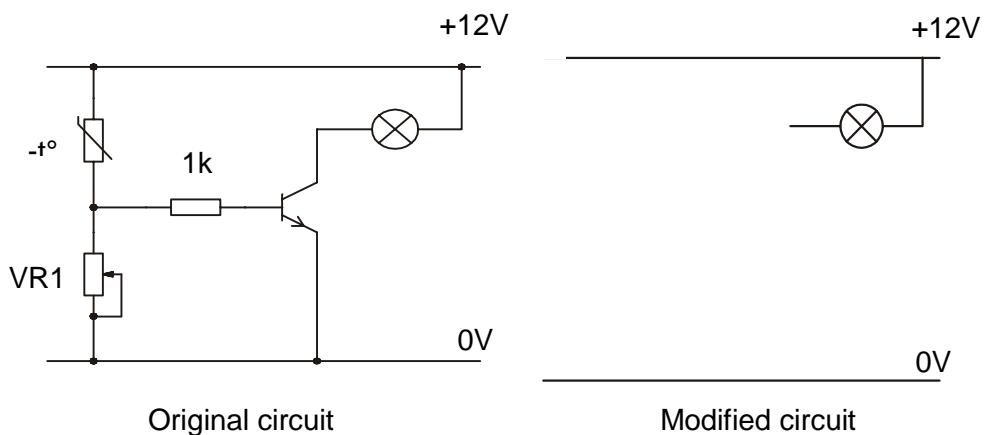

[2]

- (b) (i) An alternative circuit for the ice warning uses a Schmitt inverter IC to provide a fast switching action. Fig. 7 shows the outline of the IC.

The connections needed for the IC are:-

0V to pin 7 signal input to pin 1

12V to pin 14 signal output to pin 2

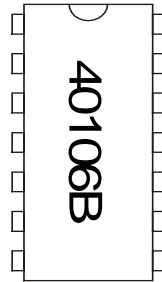

Fig. 7

Write the connections against the appropriate pin on Fig. 7. [1]

- (ii) Fig. 8 shows part of the alternative circuit.

Describe two ways that the signal has changed at the output.

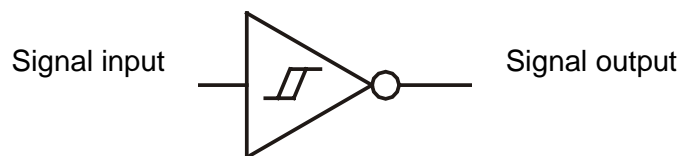
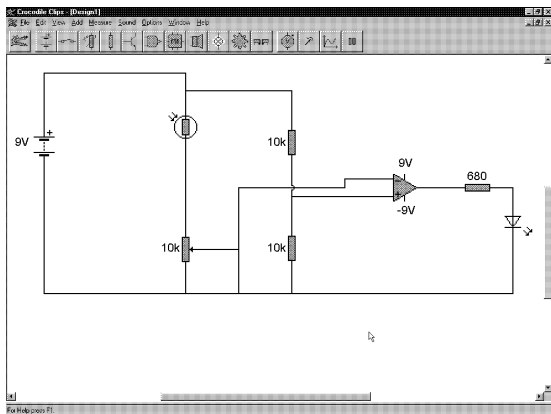

Fig. 8

1 _____ [1]

2 _____ [1]

- 4 When designing electronic circuits the correct operation of the circuit has to be tested before manufacture. Fig. 9 shows two ways of testing a circuit.



CAD software

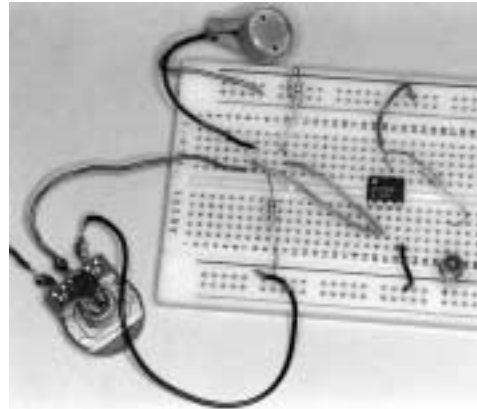

breadboard

Fig. 9

- (a) (i) State two reasons for using CAD software to test a circuit.

1 _____

2 _____

[2]

- (ii) Describe two advantages, other than cost, of using a breadboard instead of using CAD software.

1 _____

2 _____

[2]

- (b) (i)** PCB design software will often allow information to be saved in a way that is suitable for directly operating a CNC drill or milling machine.

Explain why this method is mainly used for batch production of circuit boards rather than for job (one off) production.

[2]

- (ii)** Chemicals used in the manufacture of PCBs can cause environmental damage if they are not properly disposed of.

State two ways of assessing risk before disposing of the chemicals.

1 _____

2 _____

[2]

- (c) Fig. 10a shows the design for panel cut-outs to allow sound from a speaker to be heard. The panel is shown in Fig. 10b in a CNC milling machine.

- (i) The machine will be unable to produce the cutouts as shown.

Use notes or sketches to show how the design of the slots could be altered to allow the machine to produce them.

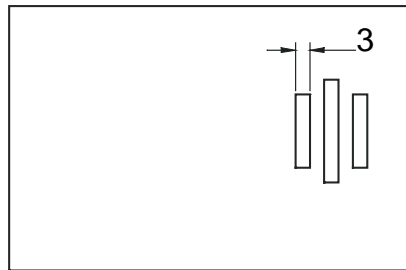

Fig. 10a

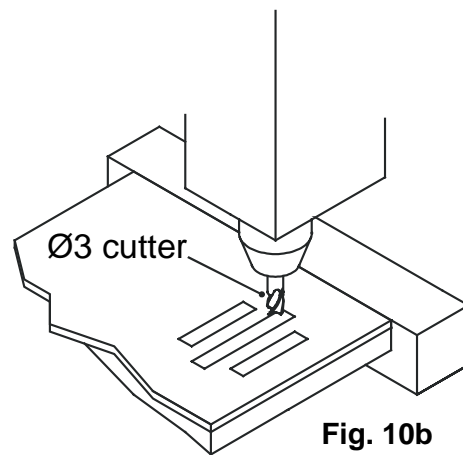

Fig. 10b

[1]

- (ii) Explain why it is unlikely that a large batch of panels would be produced in this way.

[1]

5 (a) Fig. 11 shows a multimeter case of the type frequently used in schools.

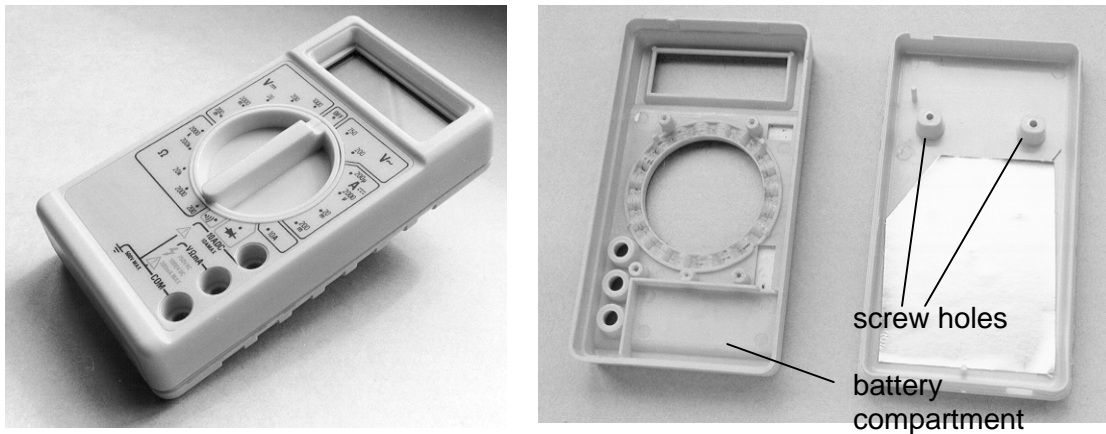

Fig. 11

(i) Describe one feature of the case that could indicate injection moulding as a manufacturing method.

_____ [1]

(ii) State two properties that a suitable material for the multimeter case will need.

1 _____

2 _____ [2]

- (b) (i) Fig. 12 shows clips that hold the display in position. Tests on the material used for the clips show that it can crack after repeated flexing.

Fig. 12

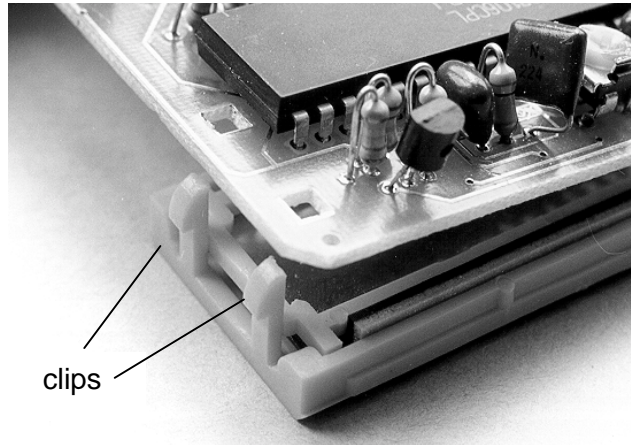

Explain why this is unlikely to cause a problem.

[1]

- (ii) The display of the multimeter shown in Fig. 13 is a liquid crystal display (LCD).

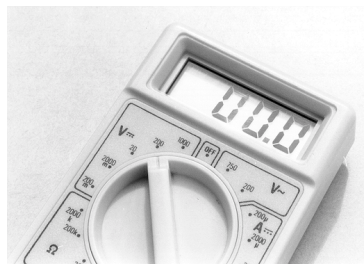

Fig. 13

Explain why an LED display would not be suitable.

[1]

- (iii) The display is housed in a deep recess in the body of the multimeter. Give a possible reason for this.

[1]

- (c) (i) Fig. 14 shows a view of the circuit board.

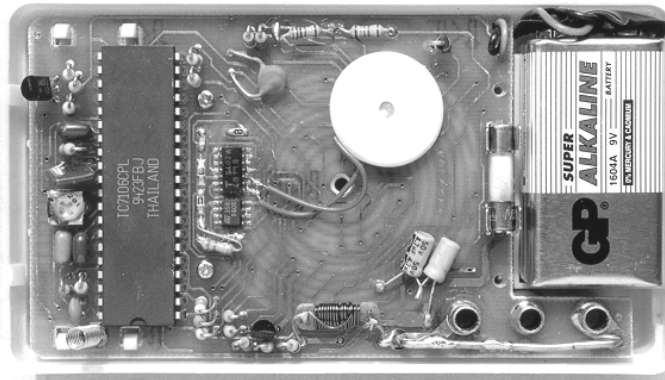

Fig. 14

Describe two visible features indicating that the designers have tried to make the unit as compact as possible.

[2]

- (ii) Identify two components in the multimeter that required accurate measurements to be taken before the design of the case and circuit board could be finalised.

1 _____

2 _____

[2]

OXFORD CAMBRIDGE AND RSA EXAMINATIONS
General Certificate of Secondary Education

DESIGN AND TECHNOLOGY
(SYSTEMS AND CONTROL TECHNOLOGY)

PAPER 3: ELECTRONIC PRODUCTS

FOUNDATION TIER

MARK SCHEME





Specimen Paper 2003

1957/3

1953/1

1053/1

1 (a) (i)

A	
C	
D	
E	
B	

[4]

(ii) Component **D** or **LDR** or **light dependent resistor**

[1]

(b) (i) Gold, Tin, Brass, 1 mark for each, total 3.

[3]

(ii) Explanation to mention corrosion or rusting. 1 mark for single word answer.

[2]

[Total: 10]

2 (a) (i) The meter should be set to a resistance range.

[1]

(ii) There is no resistance between the probes, 1 mark.
No break in track, 1 mark.

[2]

(b) (i) LED to battery negative 1 mark, resistor in series 1 mark,
probes correctly connected 1 mark each.

[4]

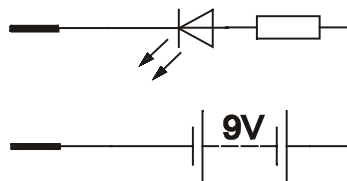

(ii) Resistor is to protect the LED, 1 mark, by limiting current to it, 1 mark.

[2]

(iii) 470R

[1]

[Total: 10]

- 3 (a) (i) To allow adjustment / compensation of switching point / threshold. 1 mark for each. [2]
- (ii) 31k2 to 46k8. 1 mark for each value correct. [2]
- (iii) 0.436mA, 1 mark. [1]
- (iv) VR1 in correct location, 1 mark. Thermistor in correct location, 1 mark. [2]

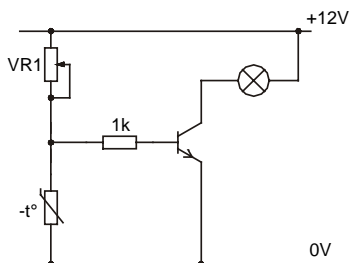

- (b) (i) All connections must be correct. [1]

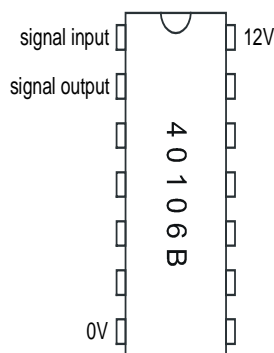

- (ii) Signal is inverted 1 mark. [2]
Signal is 'cleaned up' or rise and fall time improved 1 mark. [2]

[Total: 10]

- 4 (a) (i) Changes to components can be made quickly, no chance of damaged components, test measurements easily made, Easy to see logic / voltage at each stage. 1 mark for each valid reason. [2]
- (ii) Size of components can be seen, real response may be different to simulated circuit, tests can be made in correct situation, e.g. light / dark, no need for expensive equipment / software. 1 mark for each valid reason. [2]

- 4 (b) (i) Time taken to set machine up, expense of CNC machines, time taken to allow for different hole sizes, 1 mark each for reason related to time / expense. [2]
- (ii) Manufacturers data sheet, COSHH datasheet. 1 mark for each. [2]
- (c) (i) Notes or sketches to show the slots with round ends to match shape of cutter. [1]
- (ii) Machining time would be too long, more likely to be injection moulded, high cost of machine. [1]
- [Total: 10]**

- 5 (a) (i) Evidence of draft or taper angle, material used, internal webs, fillets / radius on corners, marks left by ejector pins etc. [1]
- (ii) Material must be an electrical insulator, able to withstand likely working temperatures, slightly flexible, not brittle, available in different colours, thermoplastic, suitable for injection moulding, 1 mark each for valid property. [2]
- (b) (i) It is likely that the display will remain in place during working life of meter, it will only need to be flexed a small number of times. [1]
- (ii) High current draw of LED display, frequent battery replacement needed. [1]
- (iii) To avoid reflections obscuring the display, to provide some protection from scratching / damage. [1]
- (c) (i) Use of resistors in vertical position, PCB fits right up to edge of case, surface mount components, PCB cut to follow shape of battery, no IC holders used. 1 mark each for two valid responses. [2]
- (ii) Battery, fuse (length), diameter of lead connector plugs, display dimensions, main IC. 1 mark for each component. [2]
- [Total: 10]**

Total mark available: 50