

Surname		Other Names	
Centre Number		Candidate Number	
Candidate Signature			

General Certificate of Secondary Education
November 2006

SCIENCE: DOUBLE AWARD A (MODULAR)
CHEMISTRY A (MODULAR)
Earth Materials (Module 06)

346006



Thursday 23 November 2006 Morning Session

For this paper you must have:

- a black ball-point pen
- an objective test answer sheet

You may use a calculator.

Time allowed: 30 minutes

Instructions

- Fill in the boxes at the top of this page.
- Check that your name, candidate number and centre number are printed on the separate answer sheet.
- Check that the separate answer sheet has the title 'Earth Materials' printed on it.
- Attempt **one Tier only**, either the Foundation Tier **or** the Higher Tier.
- Make sure that you use the correct side of the separate answer sheet; the Foundation Tier is printed on one side and the Higher Tier on the other.
- Answer **all** the questions for the Tier you are attempting.
- Record your answers on the separate answer sheet only.
- Do all rough work in this book, **not** on your answer sheet.

Instructions for recording answers

- Use a **black ball-point pen**.

- For each answer **completely fill in the circle** as shown:

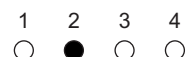

- Do **not** extend beyond the circles.

- If you want to change your answer, **you must** cross out your original answer, as shown:

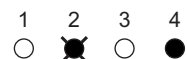

- If you change your mind about an answer you have crossed out and now want to choose it, draw a ring around the cross as shown:

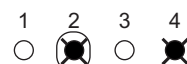

Information

- The maximum mark for this paper is 36.

Advice

- Do **not** choose more responses than you are asked to. You will lose marks if you do.
- Make sure that you hand in both your answer sheet and this question paper at the end of the test.
- If you start to answer on the wrong side of the answer sheet by mistake, make sure that you cross out **completely** the work that is not to be marked.

You must do **one Tier** only, **either** the Foundation Tier **or** the Higher Tier.
The Higher Tier starts on page 14 of this booklet.

FOUNDATION TIER

SECTION A

Questions **ONE** to **FIVE**.

In these questions match words in the list with the numbers.

Use **each** answer only **once**.

Mark your choices on the answer sheet.

QUESTION ONE

This question is about gases.

Match words from the list with the numbers **1–4** in the table.

carbon dioxide

nitrogen

oxygen

sulphur dioxide

Gas	What we can say about the gas
1	it is formed when sulphur burns in air
2	it is produced in the thermal decomposition of magnesium carbonate
3	it makes up about $\frac{4}{5}$ of the Earth's atmosphere
4	it reacts with carbon to form carbon dioxide

QUESTION TWO

This question is about limestone.

Match words from the list with the numbers **1–4** in the sentences.

to make cement

to make glass

to make quicklime

to make water less acidic

Limestone is added to lakes . . . **1**

Limestone is heated in a kiln . . . **2**

Limestone is mixed with clay and then heated . . . **3**

Limestone is mixed with sand and soda, and then heated . . . **4**

QUESTION THREE

This question is about elements found in compounds and mixtures.

Match words from the list with the numbers **1–4** in the table.

air

hydrocarbon

quicklime

soda

Compound or mixture	An element found in the compound or mixture
1	calcium
2	hydrogen
3	nitrogen
4	sodium

Turn over ►

QUESTION FOUR

This question is about tectonic plates.

Match words from the list with the numbers **1–4** in the sentences.

continental drift

convection currents

radioactive processes

volcanic eruptions

Wegener suggested that in the past there was a single, large landmass.

This split up and the smaller landmasses moved apart. We call this process . . . **1**

Tectonic plates move because of . . . **2** . . . in the Earth's mantle.

The heat required for this movement to occur comes from natural . . . **3**

At the boundaries between the tectonic plates there are often . . . **4**

QUESTION FIVE

The flow chart shows stages in the development of the Earth's atmosphere.

Match words from the list with the boxes 1–4 in the flow chart, to describe what happened in this process.

colonisation of the Earth by plants

intense volcanic activity

methane and ammonia reacted with oxygen

water vapour condensed to form the oceans

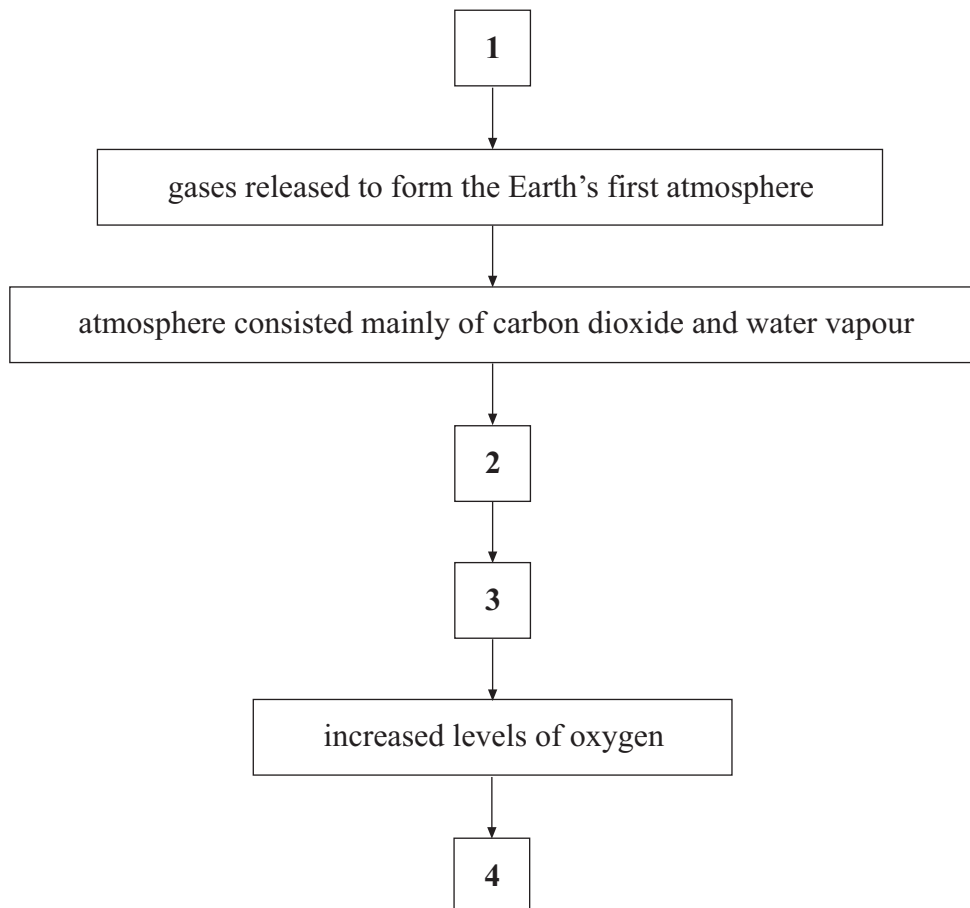

Turn over ►

SECTION BQuestions **SIX** and **SEVEN**.In these questions choose the best **two** answers.Do **not** choose more than two.

Mark your choices on the answer sheet.

QUESTION SIX

Methane is a hydrocarbon.

The diagram shows an apparatus used to investigate methane burning in air.

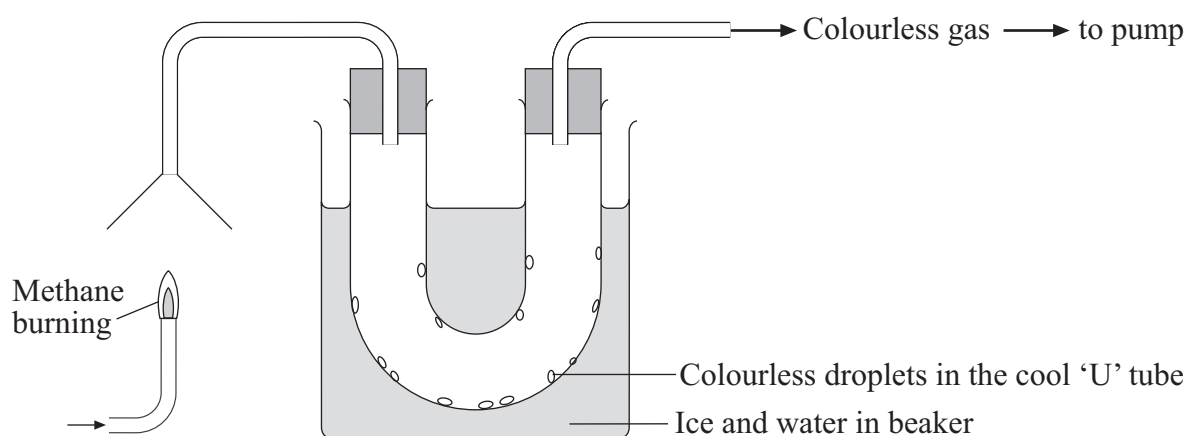
Which **two** statements are correct?**all the products of burning methane are condensed in the cool 'U' tube****in this experiment, methane reacts with oxygen****methane burns in a limited supply of air to produce poisonous sulphur dioxide****the colourless droplets in the 'U' tube are water droplets****the colourless gas produced when methane burns is hydrogen**

QUESTION SEVEN

Crude oil is a mixture of many hydrocarbons.

In a fractionating column, the crude oil is separated into a number of fractions.

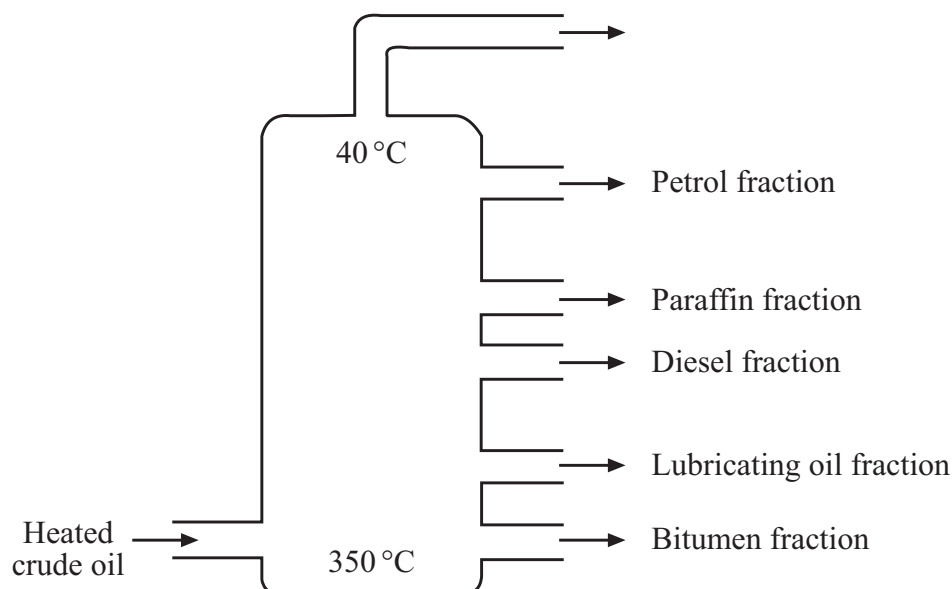

Which **two** of the statements, **J**, **K**, **L**, **M** and **N**, are correct?

- J** the fraction collected from the top of the fractionating column is useful as a fuel
- K** the fraction which contains hydrocarbons with the largest molecules is the bitumen fraction
- L** the fraction with the highest boiling point is the petrol fraction
- M** the lubricating oil fraction flows more easily than the paraffin fraction
- N** the paraffin fraction is less volatile than the diesel fraction

Turn over ►

SECTION CQuestions **EIGHT** to **TEN**.

Each of these questions has four parts.

In each part choose only **one** answer.Mark your choices on the answer sheet.

QUESTION EIGHT

The diagram shows the layered structure of the Earth and its surroundings.

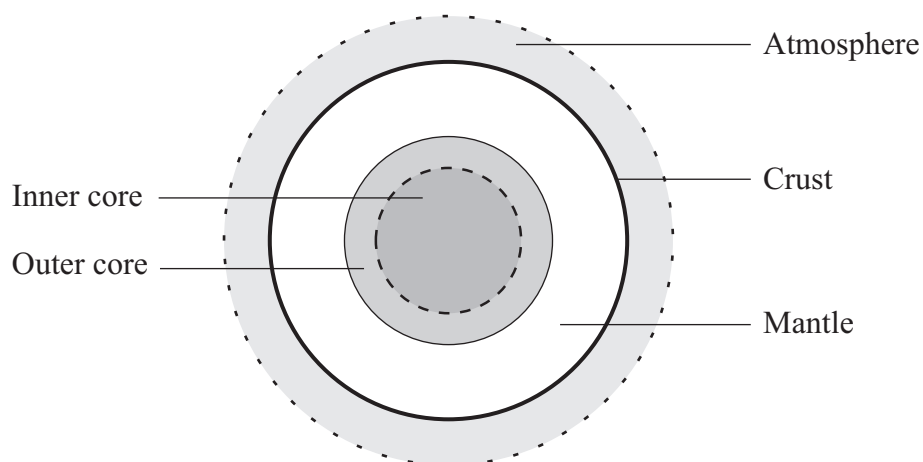
**8.1** Which parts make up the Earth's lithosphere?

- A Crust and atmosphere
- B Crust and mantle
- C Crust and upper part of the mantle
- D Outer core and lower part of the mantle

8.2 Which layer is solid, but in its upper parts can flow slowly?

- A Crust
- B Inner core
- C Mantle
- D Outer core

8.3 Which row in the table shows the composition of the inner core and the outer core?

	Inner core	Outer core
A	Liquid, iron and copper	Liquid, iron and chromium
B	Liquid, iron and nickel	Solid, iron and nickel
C	Solid, iron and chromium	Solid, iron and copper
D	Solid, iron and nickel	Liquid, iron and nickel

8.4 The material of the core and mantle . . .

- A** is less dense than the material of the crust.
- B** is made up of granitic rocks.
- C** is more dense than the material of the crust.
- D** is similar in density to the material of the crust.

Turn over for the next question

Turn over ►

QUESTION NINE

The diagrams show how one early theory attempted to explain the formation of mountains on the Earth.

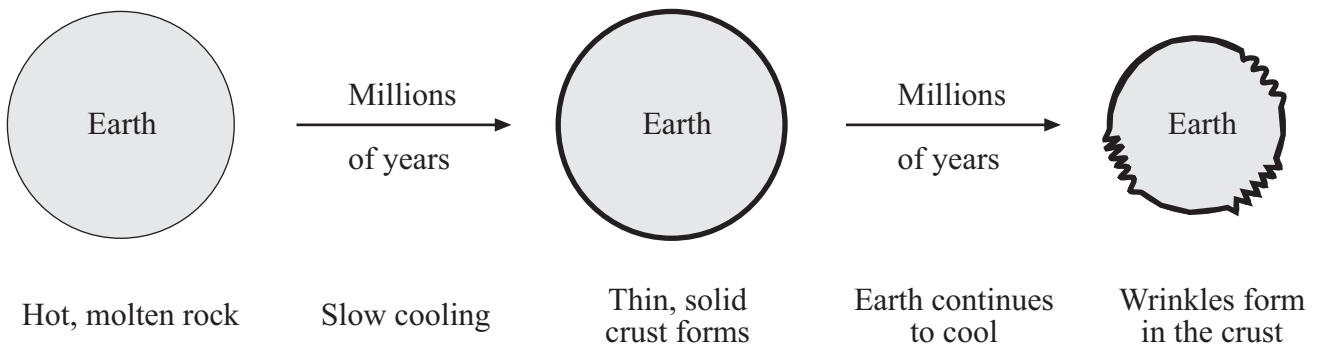

9.1 This early theory suggests that mountains are formed . . .

- A as low density rock rises from the core.
- B as molten rock escapes from the core.
- C by the shrinking of the Earth.
- D by volcanic eruptions.

9.2 One reason that this theory is **not** accepted is because we know that . . .

- A radioactive processes in the Earth release heat.
- B the Earth's crust does not change its shape.
- C the Earth is spherical.
- D the material in the Earth's interior is less dense than the crust.

9.3 Scientists now think that mountains are formed . . .

- A because the Earth is expanding as it heats up.
- B by earthquakes at plate boundaries.
- C by large-scale movements of the Earth's crust.
- D by weathering and erosion of older mountain ranges.

9.4 Metamorphic rocks are found in mountain ranges.

This shows that . . .

- A** high temperatures and pressures were involved in the formation of mountains.
- B** the rocks were formed from magma.
- C** the rocks were formed from molten material.
- D** volcanic eruptions occurred during the formation of mountains.

Turn over for the next question

Turn over ►

QUESTION TEN

The diagram shows the sequence of sedimentary rocks in one part of the Earth's crust.

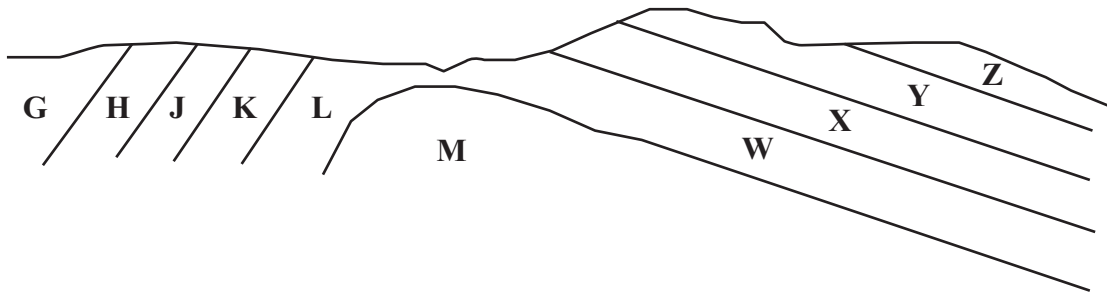

10.1 Which rock is probably the oldest?

- A Rock G
- B Rock J
- C Rock L
- D Rock M

10.2 Which rock is the same age as rock K?

- A Rock W
- B Rock X
- C Rock Y
- D Rock Z

10.3 Rock H has ripple marks.

This suggests that it . . .

- A has been folded.
- B has been subjected to high pressure.
- C is a sandstone.
- D was formed where there were waves or currents.

10.4 The rocks were laid down in horizontal layers.

What has happened to the rocks and why?

- A** They have been faulted by movement of tectonic plates.
- B** They have been faulted by shrinking of the Earth's crust.
- C** They have been folded by large forces in the Earth's crust.
- D** They have been folded by the weight of overlying rocks.

END OF TEST

You must do **one Tier** only, **either** the Foundation Tier **or** the Higher Tier.
The Foundation Tier is earlier in this booklet.

HIGHER TIER

SECTION A

Questions **ONE** and **TWO**.

In these questions match words in the list with the numbers.

Use **each** answer only **once**.

Mark your choices on the answer sheet.

QUESTION ONE

The flow chart opposite shows stages in the development of the Earth's atmosphere.

Match words from the list with the boxes **1–4** in the flow chart, to describe what happened in this process.

colonisation of the Earth by plants

intense volcanic activity

methane and ammonia reacted with oxygen

water vapour condensed to form the oceans

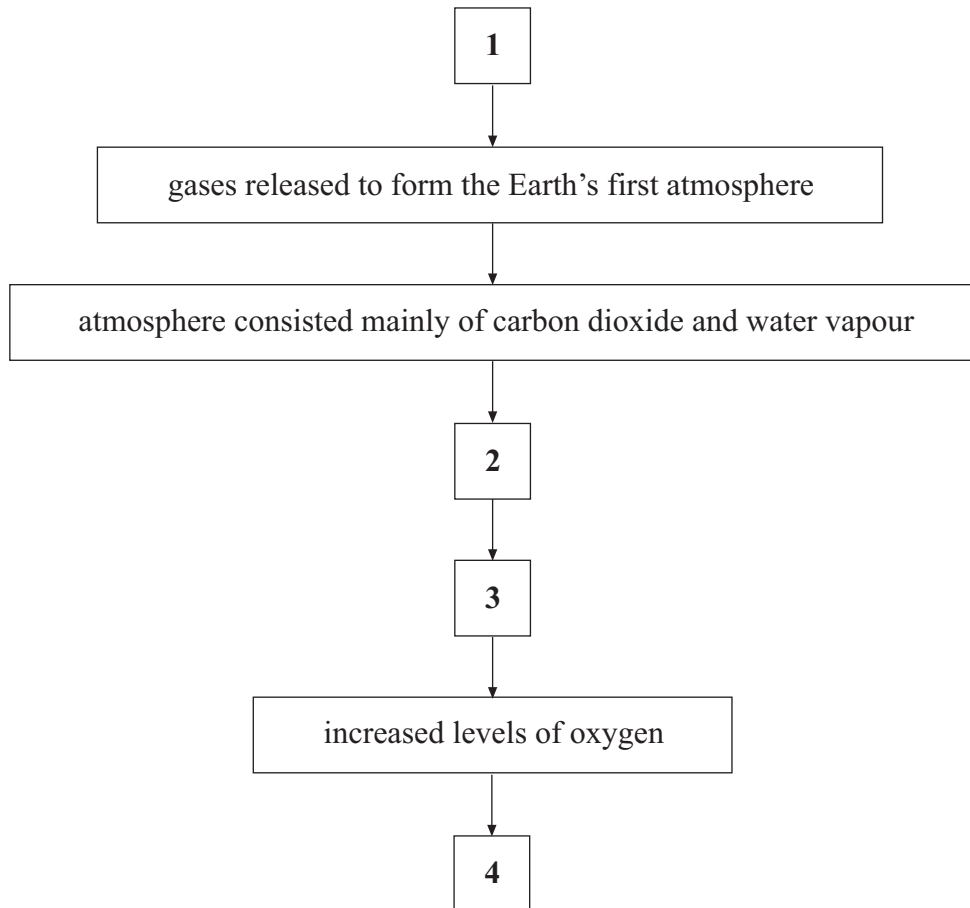

Turn over for the next question

Turn over ►

QUESTION TWO

This question is about the structural formulae of four hydrocarbons.

Match words, **E**, **F**, **G** and **H**, from the list with the numbers **1–4** below.

E a polymer

F an alkane

G an unsaturated hydrocarbon with 4 carbon atoms in each molecule

H ethene

Hydrocarbon	Formula for one molecule of the hydrocarbon
1	$\begin{array}{c} \text{H} & & \text{H} \\ & \diagdown & / \\ & \text{C} = \text{C} & \\ & / & \diagdown \\ \text{H} & & \text{H} \end{array}$
2	$\begin{array}{ccccccc} & & \text{H} & & \text{H} & & \text{H} \\ & & & & & & \\ \text{H} & & \text{C} & = & \text{C} & - & \text{C} & - & \text{C} & - & \text{H} \\ & & / & & & & & & & & \\ & & \text{H} & & & & \text{H} & & \text{H} & & \end{array}$
3	$\begin{array}{ccc} \text{H} & & \text{H} \\ & & \\ \text{H} - \text{C} & - & \text{C} - \text{H} \\ & & \\ \text{H} & & \text{H} \end{array}$
4	$\left[\begin{array}{cc} \text{H} & \text{H} \\ & \\ - \text{C} & - & \text{C} - \\ & \\ \text{H} & \text{H} \end{array} \right]_n$

SECTION BQuestions **THREE** and **FOUR**.In these questions choose the best **two** answers.Do **not** choose more than two.

Mark your choices on the answer sheet.

QUESTION THREE

Crude oil is a mixture of many hydrocarbons.

In a fractionating column, the crude oil is separated into a number of fractions.

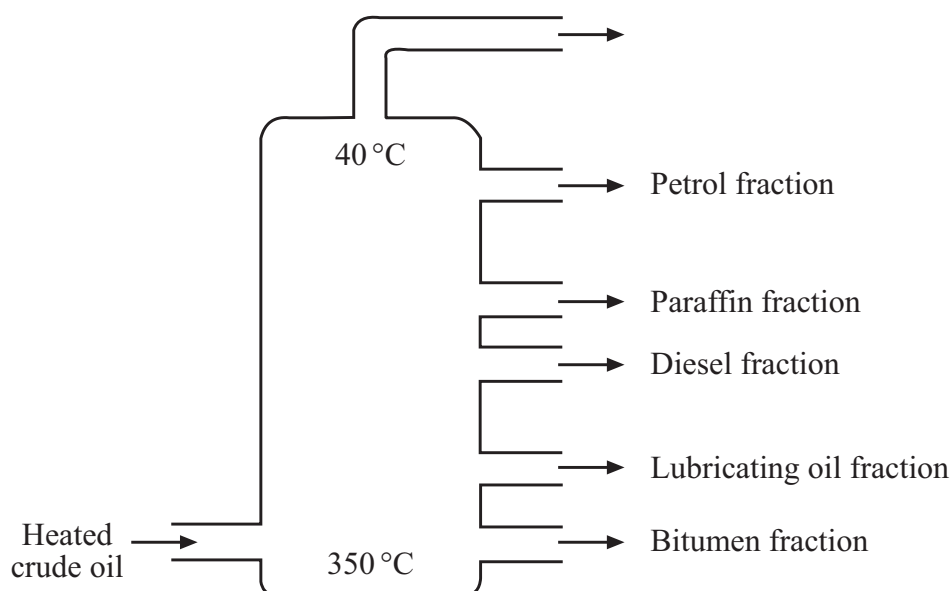
Which **two** of the statements, **J**, **K**, **L**, **M** and **N**, are correct?

- J** the fraction collected from the top of the fractionating column is useful as a fuel
- K** the fraction which contains hydrocarbons with the largest molecules is the bitumen fraction
- L** the fraction with the highest boiling point is the petrol fraction
- M** the lubricating oil fraction flows more easily than the paraffin fraction
- N** the paraffin fraction is less volatile than the diesel fraction

Turn over ►

QUESTION FOUR

This question is about poly(propene), which can be represented by the formula:

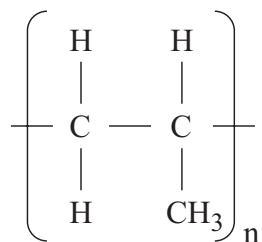

Which **two** of the statements, **P**, **Q**, **R**, **S** and **T**, are correct?

- P** in landfill sites, poly(propene) is broken down quickly by microorganisms
- Q** poly(propene) is biodegradable
- R** poly(propene) is made from propane, C_3H_8
- S** poly(propene) is made from propene, C_3H_6
- T** the carbon atoms in poly(propene) are linked by covalent bonds

Turn over for the next question

Turn over ►

SECTION CQuestions **FIVE** to **TEN**.

Each of these questions has four parts.

In each part choose only **one** answer.Mark your choices on the answer sheet.

QUESTION FIVE

The diagram shows the layered structure of the Earth and its surroundings.

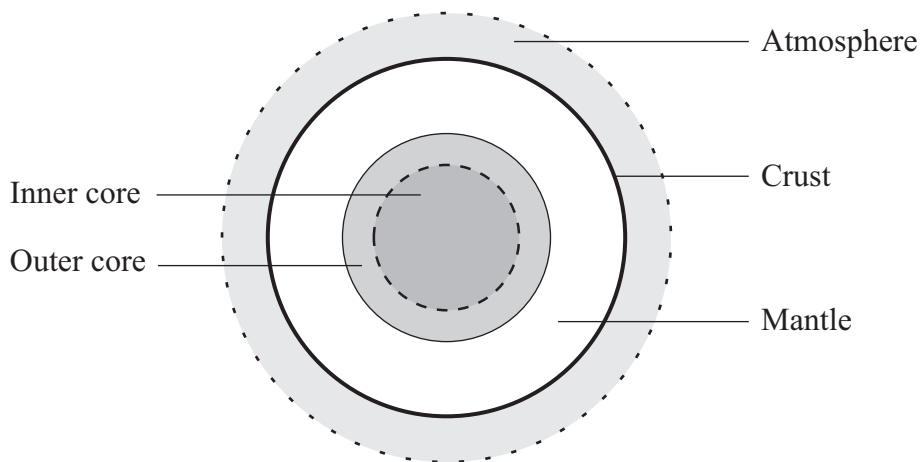
**5.1** Which parts make up the Earth's lithosphere?

- A Crust and atmosphere
- B Crust and mantle
- C Crust and upper part of the mantle
- D Outer core and lower part of the mantle

5.2 Which layer is solid, but in its upper parts can flow slowly?

- A Crust
- B Inner core
- C Mantle
- D Outer core

5.3 Which row in the table shows the composition of the inner core and the outer core?

	Inner core	Outer core
A	Liquid, iron and copper	Liquid, iron and chromium
B	Liquid, iron and nickel	Solid, iron and nickel
C	Solid, iron and chromium	Solid, iron and copper
D	Solid, iron and nickel	Liquid, iron and nickel

5.4 The material of the core and mantle . . .

- A** is less dense than the material of the crust.
- B** is made up of granitic rocks.
- C** is more dense than the material of the crust.
- D** is similar in density to the material of the crust.

Turn over for the next question

Turn over ►

QUESTION SIX

The diagrams show how one early theory attempted to explain the formation of mountains on the Earth.

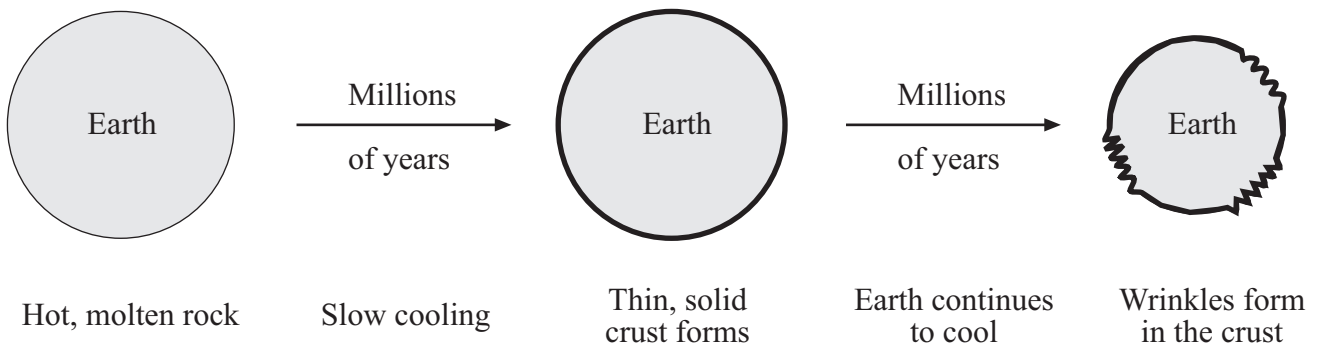

6.1 This early theory suggests that mountains are formed . . .

- A as low density rock rises from the core.
- B as molten rock escapes from the core.
- C by the shrinking of the Earth.
- D by volcanic eruptions.

6.2 One reason that this theory is **not** accepted is because we know that . . .

- A radioactive processes in the Earth release heat.
- B the Earth's crust does not change its shape.
- C the Earth is spherical.
- D the material in the Earth's interior is less dense than the crust

6.3 Scientists now think that mountains are formed . . .

- A because the Earth is expanding as it heats up.
- B by earthquakes at plate boundaries.
- C by large-scale movements of the Earth's crust.
- D by weathering and erosion of older mountain ranges.

6.4 Metamorphic rocks are found in mountain ranges.

This shows that . . .

- A** high temperatures and pressures were involved in the formation of mountains.
- B** the rocks were formed from magma.
- C** the rocks were formed from molten material.
- D** volcanic eruptions occurred during the formation of mountains.

Turn over for the next question

Turn over ►

QUESTION SEVEN

The diagram shows the sequence of sedimentary rocks in one part of the Earth's crust.

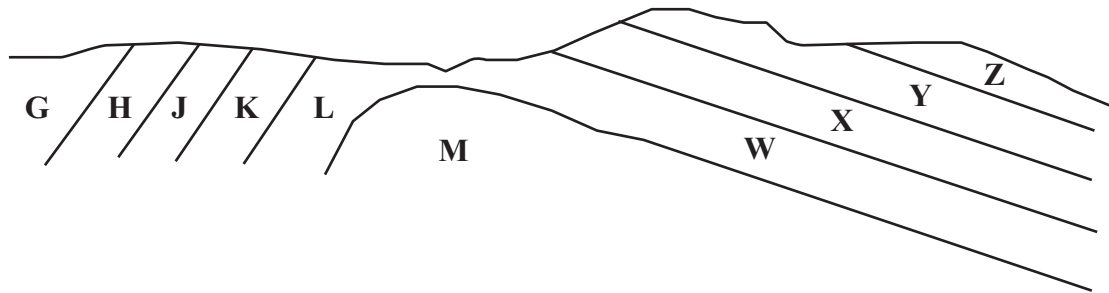

7.1 Which rock is probably the oldest?

- A Rock **G**
- B Rock **J**
- C Rock **L**
- D Rock **M**

7.2 Which rock is the same age as rock **K**?

- A Rock **W**
- B Rock **X**
- C Rock **Y**
- D Rock **Z**

7.3 Rock **H** has ripple marks.

This suggests that it . . .

- A has been folded.
- B has been subjected to high pressure.
- C is a sandstone.
- D was formed where there were waves or currents.

7.4 The rocks were laid down in horizontal layers.

What has happened to the rocks and why?

- A** They have been faulted by movement of tectonic plates.
- B** They have been faulted by shrinking of the Earth's crust.
- C** They have been folded by large forces in the Earth's crust.
- D** They have been folded by the weight of overlying rocks.

Turn over for the next question

Turn over ►

QUESTION EIGHT

The diagram shows a section of the Atlantic basin.

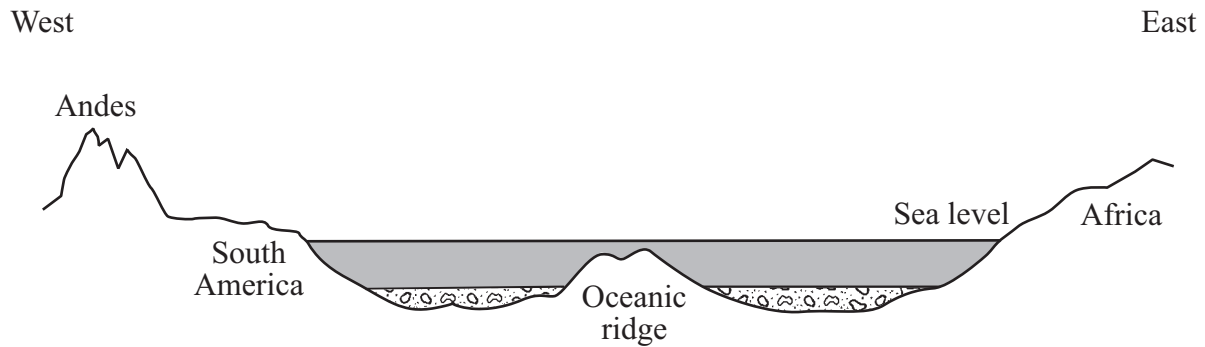

8.1 South America and Africa lie on separate tectonic plates.

Where is the boundary between these two plates?

- A Along the oceanic ridge
- B Close to the African continent
- C Through the Andes mountains
- D Through the deepest part of the Atlantic ocean

8.2 Magma rises and solidifies along the oceanic ridge.

What type of rock forms as this magma solidifies?

- A Basaltic rock
- B Granitic rock
- C Metamorphic rock
- D Sedimentary rock

8.3 New oceanic crust is formed as these two plates move apart.

What name is given to this process?

- A Erosion
- B Magnetic field reversal
- C Sea floor spreading
- D Subduction

8.4 Earthquakes often happen on the western side of South America.

This is because there is a plate boundary where . . .

- A there is volcanic activity.
- B two plates are moving apart.
- C two plates are moving together.
- D two plates are sliding past each other.

Turn over for the next question

Turn over ►

QUESTION NINE

When the Earth's atmosphere was first formed, it consisted mainly of carbon dioxide.

The percentage of carbon dioxide reduced, quickly at first and then more slowly. The percentage became steady at about 0.03%.

- 9.1** Carbon dioxide is released into the atmosphere when . . .
- A** ammonia and oxygen combine.
 - B** fossil fuels are forming.
 - C** limestone decomposes in the Earth's crust.
 - D** metamorphic rocks are forming in the oceans.
- 9.2** Carbon dioxide is removed from the atmosphere . . .
- A** by ultraviolet radiation from the Sun.
 - B** when it reacts with methane.
 - C** when it reacts with sea water to form calcium carbonate.
 - D** when it reacts with sea water to form calcium oxide.
- 9.3** Carbon dioxide can be removed from the atmosphere when . . .
- A** fossil fuels are burned.
 - B** fossil fuels are formed.
 - C** large areas of woodland are cut down.
 - D** methane reacts with oxygen.

9.4 The percentage of carbon dioxide in the atmosphere has increased in the last 200 years.

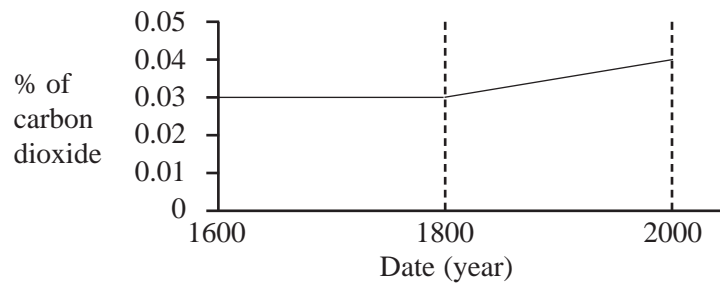

What is thought to be the main cause of this increase?

- A** Increased use of fossil fuels
- B** Increased volcanic activity
- C** Larger areas of land planted with crops
- D** Replanting of tropical rainforests

Turn over for the next question

Turn over ►

QUESTION TEN

The hydrocarbon, pentane C_5H_{12} , can be cracked in different ways.

The equations show two possible cracking reactions.

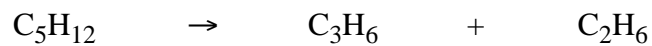

10.1 Under what conditions does cracking occur?

- A Pentane in liquid state, hot catalyst
- B Pentane in vapour state, hot catalyst
- C Pentane in liquid state, high pressure
- D Pentane in vapour state, high pressure

10.2 What are the products of the two reactions?

- A Four alkanes
- B Four alkenes
- C One alkane and three alkenes
- D Two alkanes and two alkenes

10.3 Which of the products have structures with a double bond?

- A C_2H_6 and CH_4
- B C_3H_6 and C_2H_6
- C C_3H_6 and C_4H_8
- D C_4H_8 and CH_4

10.4 The compound C_2H_6 could be broken down further.

Which equation shows what could happen?



END OF TEST

There are no questions printed on this page