

Candidate Forename		Candidate Surname	
-------------------------------	--	------------------------------	--

Centre Number						Candidate Number				
--------------------------	--	--	--	--	--	-----------------------------	--	--	--	--

**OXFORD CAMBRIDGE AND RSA EXAMINATIONS
GENERAL CERTIFICATE OF SECONDARY EDUCATION**

B631/02

GATEWAY SCIENCE

BIOLOGY B

Unit 1 Modules B1 B2 B3 (Higher Tier)

THURSDAY 14 JANUARY 2010: Morning

DURATION: 1 hour

SUITABLE FOR VISUALLY IMPAIRED CANDIDATES

Candidates answer on the Question Paper

A calculator may be used for this paper

OCR SUPPLIED MATERIALS:

None

OTHER MATERIALS REQUIRED:

Pencil

Ruler (cm/mm)

READ INSTRUCTIONS OVERLEAF

INSTRUCTIONS TO CANDIDATES

- **Write your name clearly in capital letters, your Centre Number and Candidate Number in the boxes on the first page.**
- **Use black ink. Pencil may be used for graphs and diagrams only.**
- **Read each question carefully and make sure that you know what you have to do before starting your answer.**
- **Answer ALL the questions.**
- **Write your answer to each question in the space provided, however additional paper may be used if necessary.**

INFORMATION FOR CANDIDATES

- **The number of marks is given in brackets [] at the end of each question or part question.**
- **The total number of marks for this paper is 60.**

BLANK PAGE

Answer ALL the questions.

SECTION A – MODULE B1

1 Nathan is a good athlete.

He hopes to compete in the 100 m sprint at the 2012 London Olympics.

(a) Nathan runs in a 100 m sprint.

Immediately after he finishes, he feels pain in his muscles.

The pain is caused by lactic acid.

What causes lactic acid to build up in his muscles?

_____ [1]

BLANK PAGE

(b) Nathan records his pulse rate every minute after the run has finished.

Look at the table.

It shows how Nathan's pulse rate changes after the end of the run.

TIME AFTER RUN HAS FINISHED IN MINUTES	PULSE RATE IN BEATS PER MINUTE
1	140
2	122
3	100
4	84
5	72
6	60
7	60
8	60

(i) Finish the graph of Nathan's results on the next page by:

- plotting the rest of the points**
- drawing the best curve.**

[2]

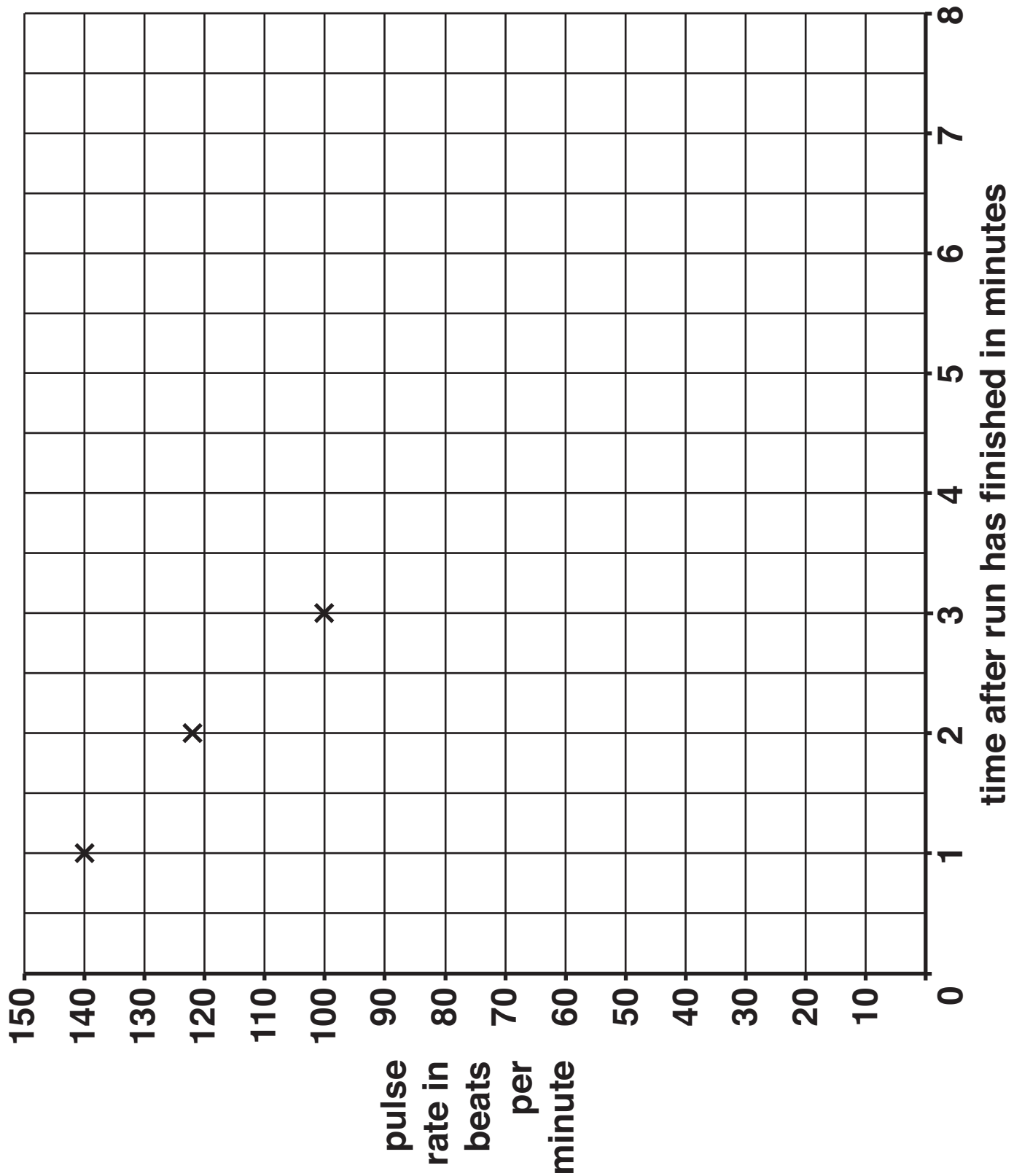

(ii) After the end of the run Nathan's pulse rate returned to his resting pulse rate.

How long did this take? _____ minutes [1]

(c) Nathan's pulse rate does not return to normal immediately after the run.

Explain why.

[2]

[Total: 6]

2 Annabelle is feeling unwell.

She is suffering from the symptoms of flu. These include a fever, sore throat and a runny nose.

(a) Flu is an infectious disease caused by a virus. The virus is a pathogen.

How do pathogens cause the symptoms of a disease?

[1]

(b) Annabelle's body can defend itself by producing antibodies when a pathogen invades.

Her antibodies give her immunity if the same pathogen invades again.

This is called ACTIVE IMMUNITY.

Doctors can immunise her against harmful pathogens by injecting vaccines.

(i) Look at the statements about immunisation.

Put ticks (✓) in the boxes next to the correct statements.

A non-living pathogen is injected which makes the body produce antibodies.

A living and active pathogen is injected which carries antigens on its surface.

A weakened, living pathogen is injected which carries antigens on its surface.

A living and active pathogen is injected which makes the body produce antibodies.

[2]

(ii) People can also have PASSIVE IMMUNITY.

Write about how passive immunity is different from active immunity.

[1]

[Total: 4]

3 This question is about the nervous system.

Jeanette is cleaning her desk.

She accidentally puts her finger on the point of a drawing pin.

Without thinking, she quickly pulls her hand away from the drawing pin.

(a) In this response

(i) what is the stimulus?

_____ [1]

(ii) what is the effector?

_____ [1]

(b) Jeanette has a headache. She decides to take a painkiller.

Look at the list of drugs.

Which one is a painkiller?

Put a ring around the correct answer.

ASPIRIN

ECSTASY

LSD

NICOTINE

[1]

(c) The diagram below shows the structure of a motor neurone.

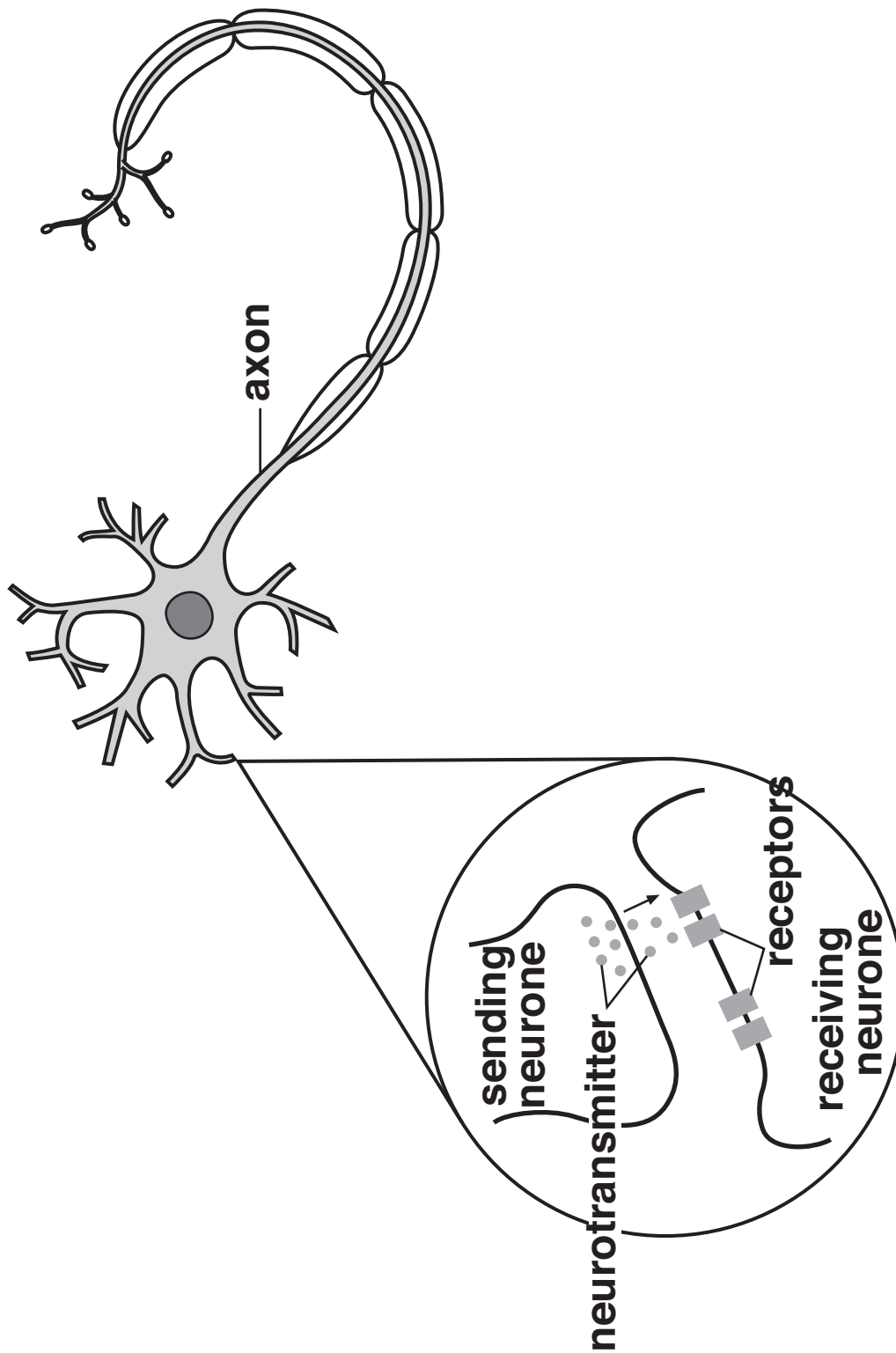

(i) Impulses pass between neurones.

There is a gap between each neurone.

What is the name of this gap?

_____ [1]

(ii) Jeanette has a cup of coffee.

Coffee contains a drug called caffeine.

She feels more alert after she has had the coffee.

Write about WHY and HOW caffeine makes her more alert.

_____ [2]

[Total: 6]

4 This question is about reproduction and inheritance.

(a) James and Carol have a daughter called Claire.

Carol needed fertility treatment before Claire was born.

This is because her ovaries did not produce enough of one type of cell.

(i) Name the PROCESS that releases this cell.

_____ [1]

(ii) Carol's doctor prescribed a course of drugs to help Carol become more fertile.

The drugs are given to replace a group of substances that Carol's body does not make properly.

Name this group of substances.

_____ [1]

(b) Claire has inherited characteristics from James and Carol.

The information for these characteristics is carried on chromosomes.

How many chromosomes are found in ONE of Claire's skin cells?

_____ [1]

(c) Claire is a girl.

What sex chromosomes does she have?

_____ [1]

[Total: 4]

SECTION B – MODULE B2

5 Lichens are an example of an indicator species.

The higher the level of sulfur dioxide pollution the less likely lichens are to be found.

They can be found growing on surfaces such as rocks, walls and gravestones.

(a) Iain is investigating how many lichens are growing in different parts of the country.

He does this by looking at gravestones in three different towns.

These are his results.

	TOWN		
	SMITHTON	HUGHESLY	CHAPMANSTOW
total number of gravestones looked at	80	45	64
number of gravestones with lichens	12	9	16
percentage of gravestones with lichens	15%		25%

- (i) Calculate the percentage of gravestones with lichens in Hughesly.

answer _____% [2]

- (ii) Which town is likely to have the LEAST sulfur dioxide pollution?

_____ [1]

- (iii) Suggest how Iain could have produced more reliable data.

_____ [1]

(b) Lichens are made of fungi and algae.

The fungi give the algae water and minerals that the fungi absorb from whatever they are growing on.

The algae give the fungi food that the algae make by photosynthesis.

(i) What term is used to describe the relationship between the fungi and the algae?

_____ [1]

(ii) Fungi are not classified as either animals or plants.

Why are fungi not classified as animals or plants?

They are not animals because _____

They are not plants because _____

_____ [2]

(c) Lichens are found on surfaces such as rocks, walls and gravestones.

Suggest why they are NOT usually found on soil.

[2]

[Total: 9]

6 A wheat flower is green, very small and lacks petals.

It has several anthers hanging outside the flower and feathery stigmas.

(a) (i) How is pollen transferred from one wheat flower to another?

_____ [1]

(ii) Look at the descriptions of pollen.

Which ONE describes wheat pollen?

Put a tick (✓) in the correct box.

lightweight and sticky	
heavy and sticky	
lightweight and small	
heavy and small	
large and sticky	
small and sticky	

[1]

(b) Wheat makes food by photosynthesis.

(i) Complete the word equation for photosynthesis.

carbon dioxide + _____ →

glucose + _____ [2]

(ii) The glucose made by photosynthesis is turned into starch for storage.

Why is starch better for storage than glucose?

_____ [1]

(iii) Mary measures the concentration of carbon dioxide in a field of wheat.

Complete the line on the graph to show how the concentration of carbon dioxide changes over 24 hours.

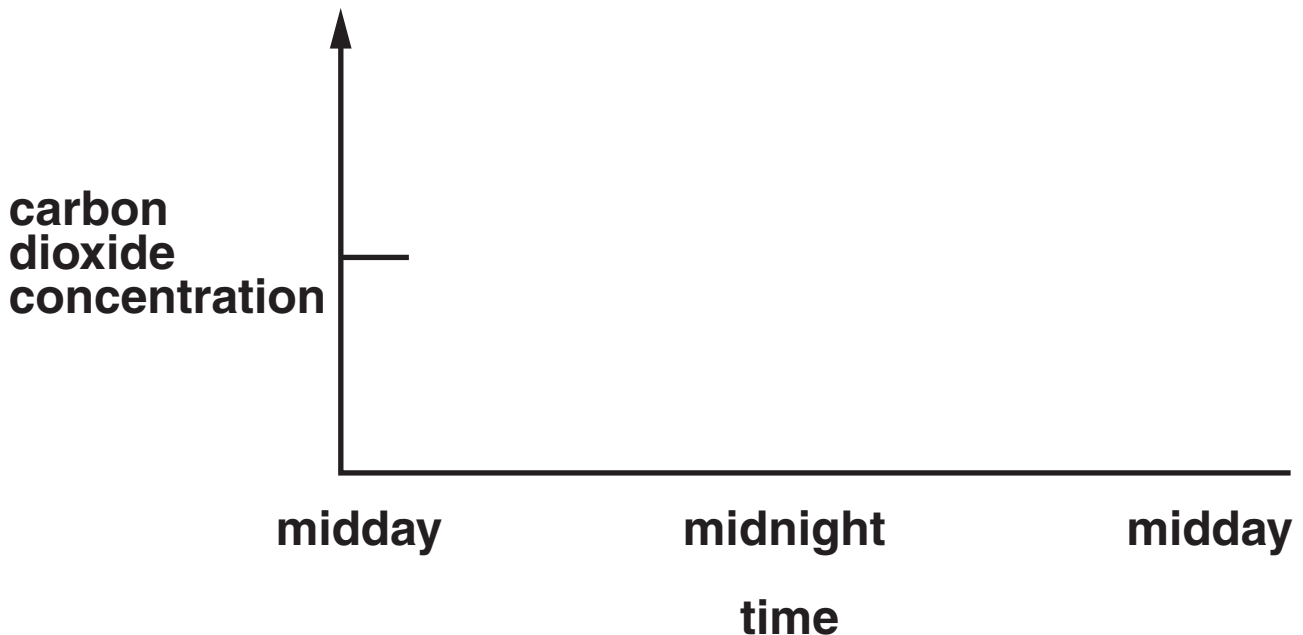

[1]

[Total: 6]

7 Mosasaurs are animals that lived in the sea around 65 to 70 million years ago.

Mosasaurs had a large head and a streamlined body ending in a long, paddle-like tail. They were about 15m long. Their eyes faced forward and their large, powerful jaws contained many sharp teeth. They had four small flippers.

(a) We know about mosasaurs from their fossils.

Describe how mosasaur fossils were formed.

[2]

(b) The first known mosasaur fossil was found in the Netherlands in 1766.

At first people thought the fossil came from a crocodile.

Later they realised it was from an extinct species.

One reason species become extinct is because of competition.

Suggest ONE OTHER reason why the mosasaur might have become extinct.

[1]

- (c) The idea that species become extinct is part of Darwin's theory of evolution by natural selection.

Look at the stages of natural selection.

Put them in the correct order by writing numbers in the boxes.

The first stage has been done for you.

competition for limited resources	
inheritance of successful genes	
natural variation	1
survival of the fittest	

[1]

- (d) Many people did not like the idea of evolution by natural selection when Darwin first suggested it.

Why did many people not like these new ideas?

[1]

[Total: 5]

BLANK PAGE

SECTION C – MODULE B3

8 Human blood contains red cells and white cells.

(a) White blood cells defend against disease.

Write down how white blood cells are adapted to do their job.

[1]

(b) Red blood cells contain haemoglobin.

Explain how haemoglobin is used to transport oxygen.

[2]

(c) Blood is carried to the heart in veins.

Veins have special features which help them carry blood at low pressure.

Write about TWO ways veins are adapted.

1. feature _____

reason _____

2. feature _____

reason _____ [2]

[Total: 5]

9 Butch is a husky dog.

Huskies, like Butch, are a breed of dog used for pulling sledges.

(a) Husky dogs are produced by selective breeding.

They need to be strong to pull sledges.

To breed the best huskies the strongest females are bred with the strongest males.

Describe the next stages in selective breeding.

[2]

(b) Scientists could clone Butch using a similar technique to the one that produced Dolly the sheep.

Look at the flow diagram.

It shows the stages in the cloning technique.

COMPLETE the diagram by writing in the missing stages.

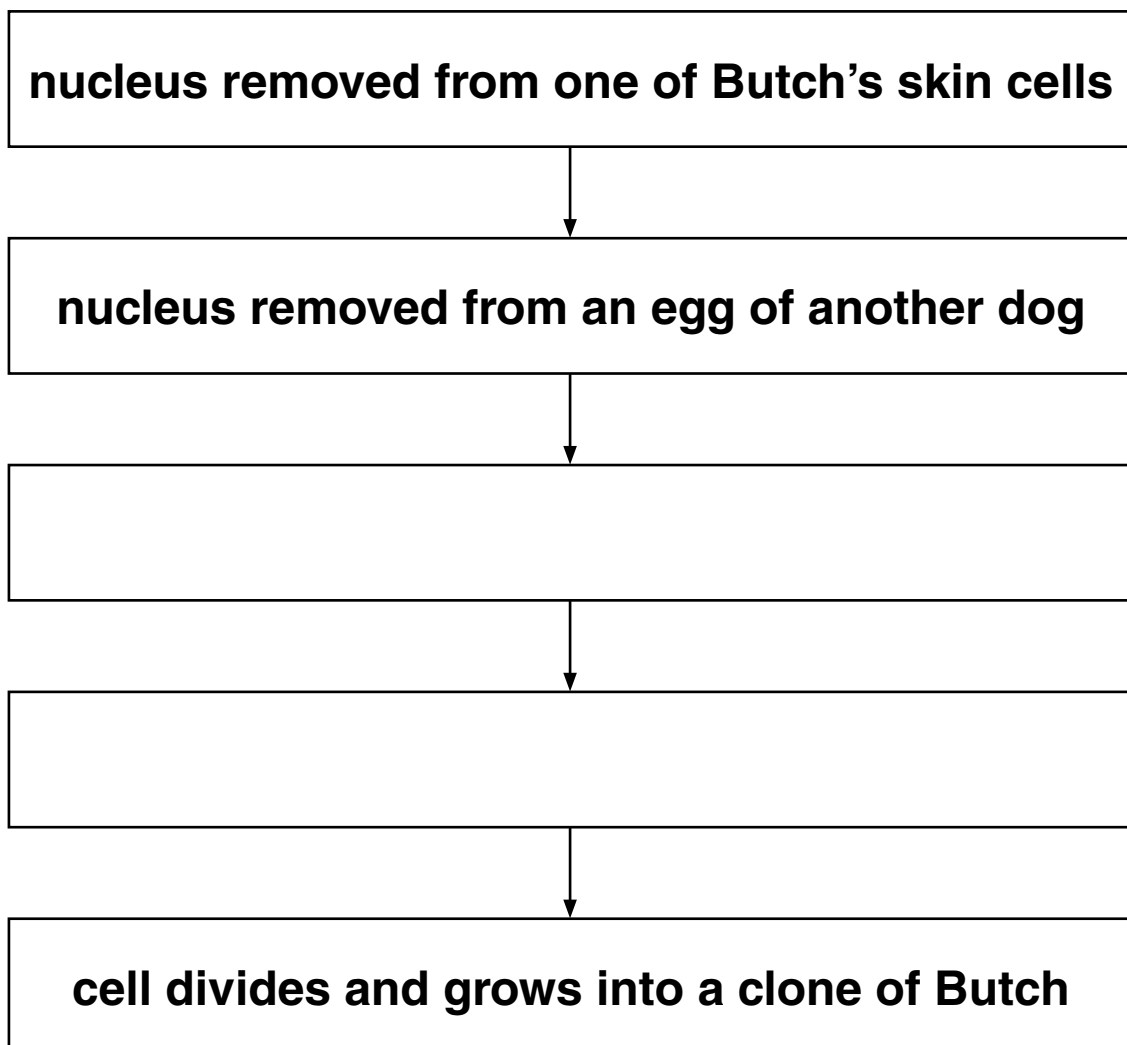

[2]

[Total: 4]

10 Chicken embryos grow from a single cell to become chicks ready to hatch.

(a) The embryo grows because its cells divide.

(i) Write down the name of this type of cell division.

_____ [1]

(ii) Describe ONE thing that happens to chromosomes during cell division.

_____ [1]

(b) The embryo formed after an egg cell was fertilised by a sperm cell.

Sperm cells contain enzymes.

The enzymes are found in part X.

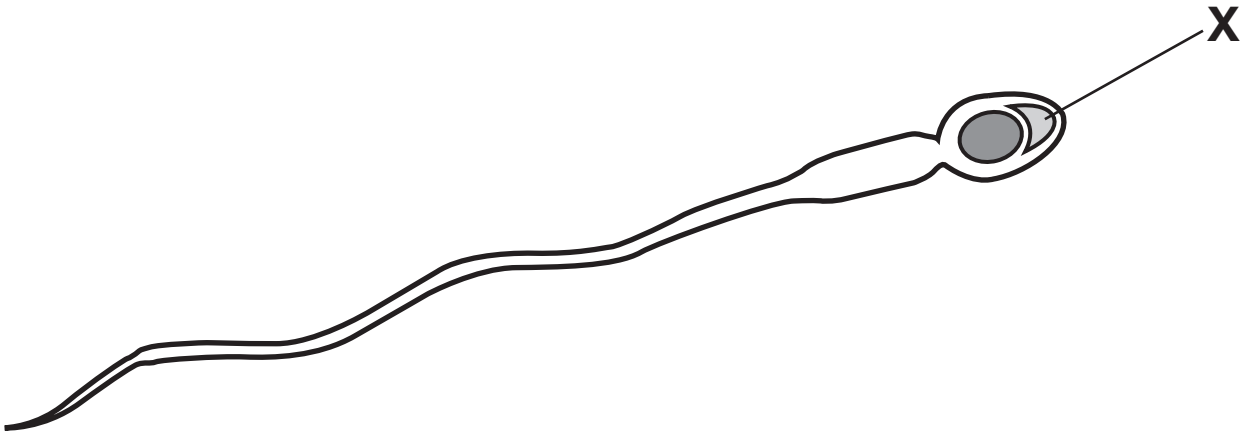

Write down the name of part X.

_____ [1]

(c) Chicken embryos contain STEM CELLS.

Write down the meaning of the term stem cells.

_____ [1]

[Total: 4]

11 This question is about plant hormones.

(a) Hormones control growth in plants.

Look at the list. Which statement about plant hormones is INCORRECT?

Put a cross (X) in the box next to the INCORRECT statement.

They are involved in photosynthesis.	
They are involved in responses to gravity.	
They move through the plant in solution.	
They are used to control dormancy.	

[1]

(b) Pat investigates the effect of plant hormone concentration on shoot growth.

She puts shoots of the same length in different concentrations of plant hormone.

Pat then measures the increase in length of the shoots.

The graph shows her results.

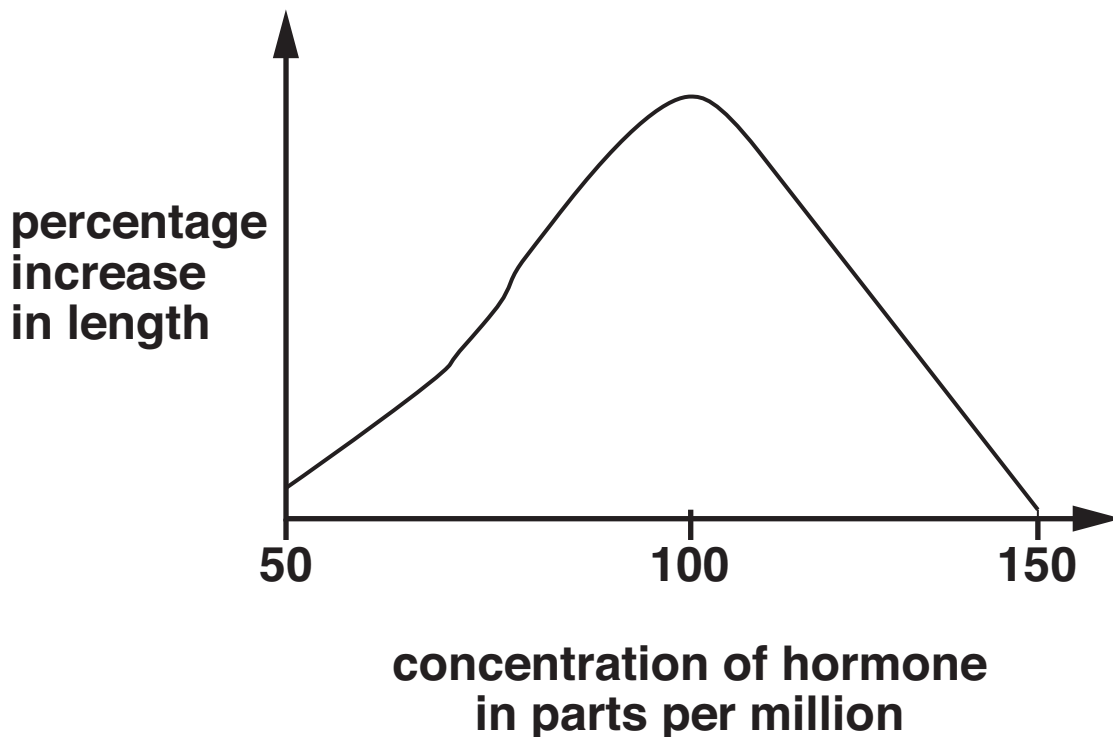

Describe the pattern in the results.

In your answer include information from the graph.

[2]

[Total: 3]

12 Look at the picture of an animal cell.

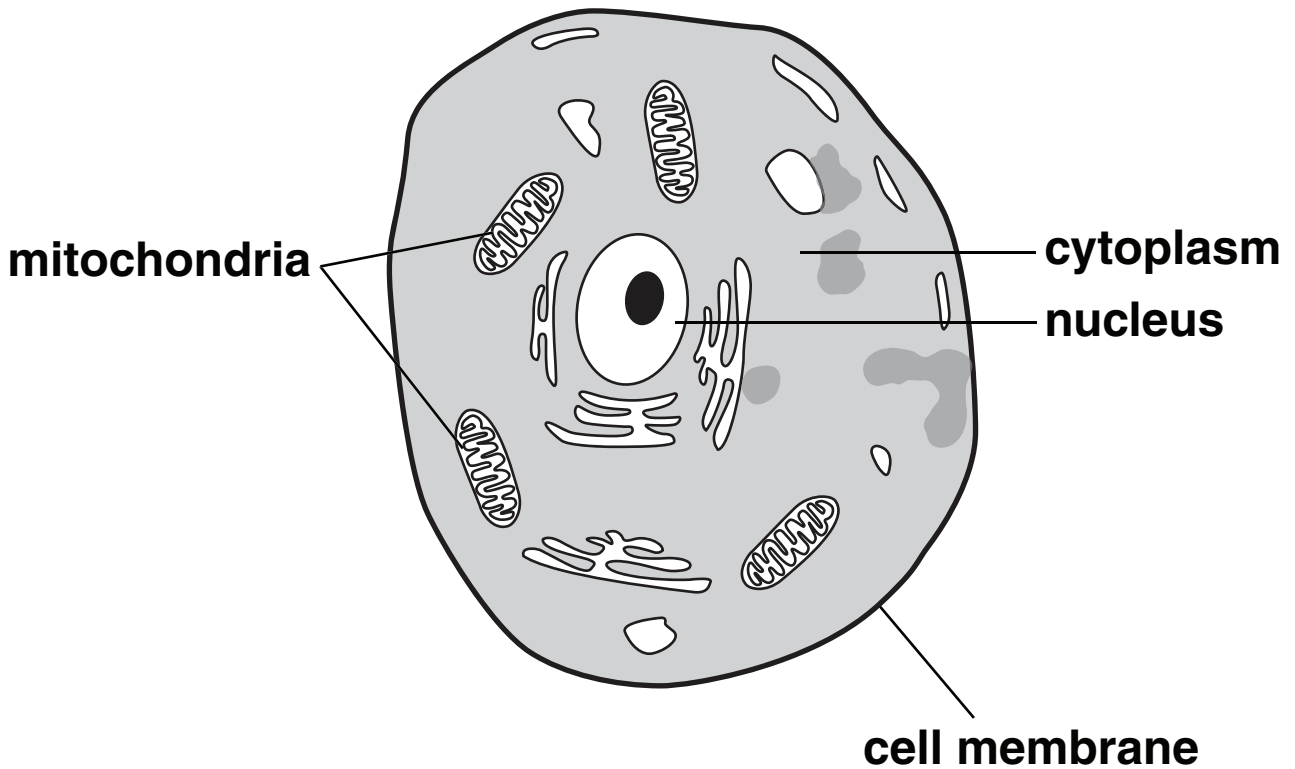

(a) Write down the name of the process that takes place in the mitochondria.

_____ [1]

(b) The nucleus contains DNA.

DNA contains bases that code for amino acids.

(i) How many bases are needed to code for one amino acid?

_____ [1]

- (ii) The diagram shows some bases in a section of DNA.

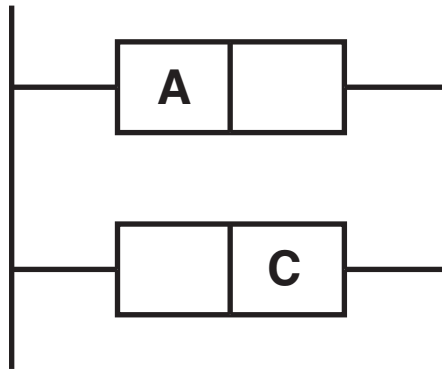

COMPLETE the diagram by writing in the missing letters.

[1]

- (c) Amino acids are used to make proteins.

What name is given to this process?

Choose from this list.

FRAGMENTATION

TRANSAMINATION

REPLICATION

SYNTHESIS

answer _____ [1]

[Total: 4]

END OF QUESTION PAPER



Copyright Information

OCR is committed to seeking permission to reproduce all third-party content that it uses in its assessment materials. OCR has attempted to identify and contact all copyright holders whose work is used in this paper. To avoid the issue of disclosure of answer-related information to candidates, all copyright acknowledgements are reproduced in the OCR Copyright Acknowledgements Booklet. This is produced for each series of examinations, is given to all schools that receive assessment material and is freely available to download from our public website (www.ocr.org.uk) after the live examination series.

If OCR has unwittingly failed to correctly acknowledge or clear any third-party content in this assessment material, OCR will be happy to correct its mistake at the earliest possible opportunity.

For queries or further information please contact the Copyright Team, First Floor, 9 Hills Road, Cambridge CB2 1GE.

OCR is part of the Cambridge Assessment Group; Cambridge Assessment is the brand name of University of Cambridge Local Examinations Syndicate (UCLES), which is itself a department of the University of Cambridge.