

Candidate Forename		Candidate Surname	
-------------------------------	--	------------------------------	--

Centre Number						Candidate Number				
--------------------------	--	--	--	--	--	-----------------------------	--	--	--	--

**OXFORD CAMBRIDGE AND RSA EXAMINATIONS
GENERAL CERTIFICATE OF SECONDARY EDUCATION**

A215/01

**TWENTY FIRST CENTURY SCIENCE
ADDITIONAL SCIENCE A**

Unit 1: Modules B4 C4 P4 (Foundation Tier)

MONDAY 25 JANUARY 2010: Afternoon

DURATION: 40 minutes

SUITABLE FOR VISUALLY IMPAIRED CANDIDATES

Candidates answer on the Question Paper

A calculator may be used for this paper

OCR SUPPLIED MATERIALS:

None

OTHER MATERIALS REQUIRED:

Pencil

Ruler (cm/mm)

READ INSTRUCTIONS OVERLEAF

INSTRUCTIONS TO CANDIDATES

- Write your name clearly in capital letters, your Centre Number and Candidate Number in the boxes on the first page.
- Use black ink. Pencil may be used for graphs and diagrams only.
- Read each question carefully and make sure that you know what you have to do before starting your answer.
- Answer ALL the questions.
- Write your answer to each question in the space provided, however additional paper may be used if necessary.

INFORMATION FOR CANDIDATES

- The number of marks is given in brackets [] at the end of each question or part question.
- The total number of marks for this paper is 42.
- A list of physics equations is printed on pages 4 and 5.
- A copy of the Periodic Table is provided.

BLANK PAGE

TWENTY FIRST CENTURY SCIENCE EQUATIONS

USEFUL RELATIONSHIPS

EXPLAINING MOTION

$$\text{speed} = \frac{\text{distance travelled}}{\text{time taken}}$$

$$\text{momentum} = \text{mass} \times \text{velocity}$$

$$\text{change of momentum} = \text{resultant force} \times \text{time for which it acts}$$

$$\text{work done by a force} = \text{force} \times \text{distance moved by the force}$$

$$\text{change in energy} = \text{work done}$$

$$\text{change in GPE} = \text{weight} \times \text{vertical height difference}$$

$$\text{kinetic energy} = \frac{1}{2} \times \text{mass} \times [\text{velocity}]^2$$

ELECTRIC CIRCUITS

$$\text{resistance} = \frac{\text{voltage}}{\text{current}}$$

$$\frac{\text{voltage across primary coil}}{\text{voltage across secondary coil}} = \frac{\text{number of turns in primary coil}}{\text{number of turns in secondary coil}}$$

$$\text{energy transferred} = \text{power} \times \text{time}$$

$$\text{power} = \text{potential difference} \times \text{current}$$

$$\text{efficiency} = \frac{\text{energy usefully transferred}}{\text{total energy supplied}} \times 100\%$$

THE WAVE MODEL OF RADIATION

$$\text{wave speed} = \text{frequency} \times \text{wavelength}$$

Answer ALL the questions.

1 Sue is a doctor.

She treats patients for either heat stroke or hypothermia at different times of the year.

(a) Draw straight lines from each SYMPTOM to the correct CONDITION.

Draw straight lines from each TREATMENT to the correct CONDITION.

<u>SYMPTOM</u>	<u>CONDITION</u>	<u>TREATMENT</u>
rapid pulse rate		wrap in wet towels
shivering	hypothermia	insulate the patient
slurred speech	heat stroke	keep the patient as still as possible
dry skin		use a fan

[4]

- (b) (i) Sue takes the temperature of a patient suffering from HEAT STROKE.

Put a ring around the temperature she is most likely to find.

34 °C

37 °C

40 °C

[1]

- (ii) Sue takes the temperature of a patient suffering from HYPOTHERMIA.

Put a ring around the temperature she is most likely to find.

34 °C

36 °C

38 °C

40 °C

42 °C

[1]

[Total: 6]

2 Barry sets up an experiment to investigate osmosis.

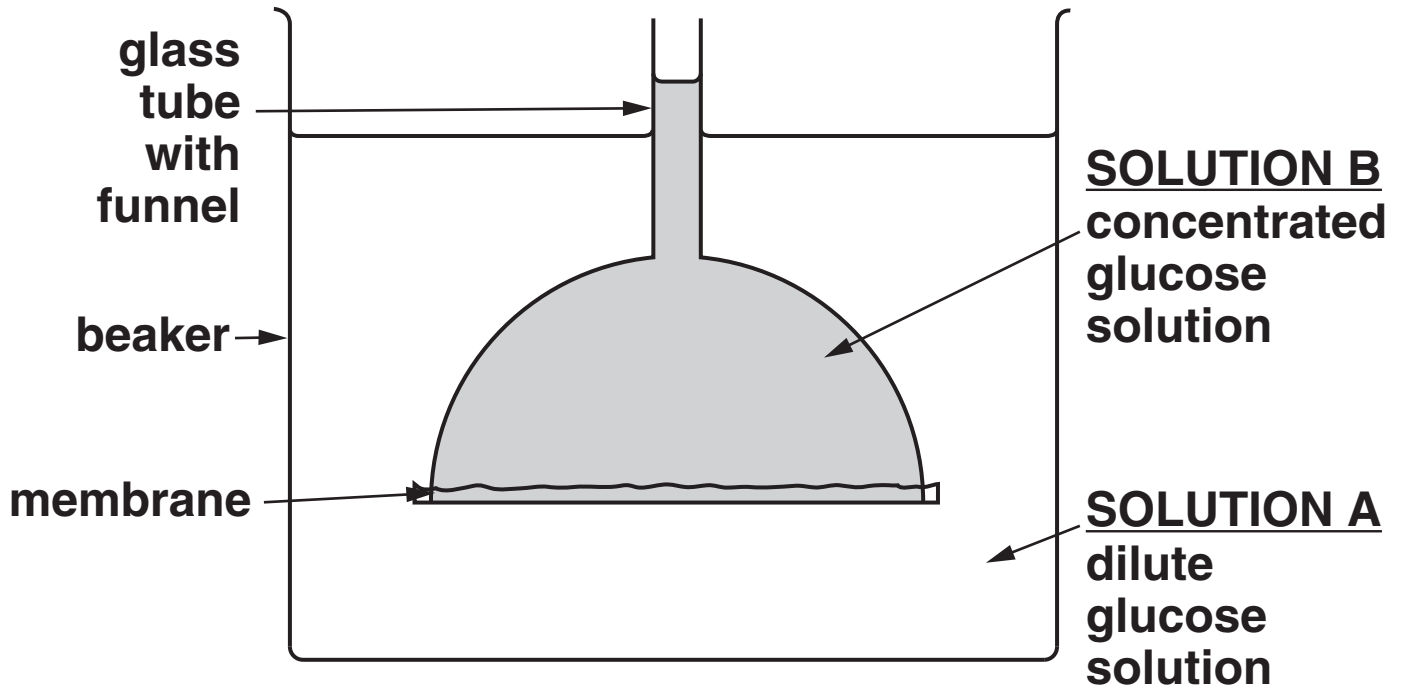

(a) What type of membrane should Barry use to investigate osmosis?

_____ [1]

(b) Barry sees that the level in the tube goes up.

Put a tick (✓) in the box next to the correct reason.

only water moves from SOLUTION A to SOLUTION B

only glucose moves from SOLUTION A to SOLUTION B

both water and glucose move from SOLUTION A to SOLUTION B

[1]

- (c) Barry repeats the experiment. He wants to change his experiment so that the level in the tube does not change.
What should he do?

Put a tick (✓) in the box next to the correct answer.

add more water to SOLUTION A

add more glucose to SOLUTION A

warm up SOLUTION A

[1]

[Total: 3]

- 3 Tina investigates the effect of temperature on enzymes.
She uses the enzyme catalase to break down hydrogen peroxide.
She collects the oxygen gas given off by the reaction.
Here are some of her results.**

TEMPERATURE OF CATALASE AND HYDROGEN PEROXIDE IN °C	VOLUME OF GAS COLLECTED IN 1 MINUTE IN CM³
20	18
30	36
40	40
90	

- (a) Suggest and explain how much gas will be produced at 90 °C.**

[2]

(b) Tina tries to use a different enzyme to break down hydrogen peroxide.

Use the lock and key model to explain why this will not work.

[3]

[Total: 5]

4 Atoms are made up of protons, neutrons and electrons.

(a) The charge and the mass of protons, neutrons and electrons are not the same.

Draw straight lines to join each type of PARTICLE to its CHARGE.

Draw straight lines to join each type of PARTICLE to its RELATIVE MASS.

<u>CHARGE</u>	<u>PARTICLE</u>	<u>RELATIVE MASS</u>
0	proton	almost zero
-1	neutron	1
+1	electron	

[2]

(b) Many chemical changes involve ions.

Draw ONE line between the two boxes which BEST describe what an ion is.

**A crystal
lattice ...**

**... which has gained or
lost electrons.**

or

or

**A group of
atoms ...**

**... which has gained or
lost protons.**

or

or

**An atom or a
group of atoms ...**

**... which has gained or
lost neutrons.**

or

or

An atom ...

**... which has moved from
one group to another.**

[2]

[Total: 4]

5 David's teacher does an experiment using sodium.

(a) The sodium is stored in a bottle of oil.
Why must it be stored in oil?

[2]

(b) Sodium is in group 1 of the Periodic Table.
Here is an outline of the Periodic Table.
The cross (X) shows one of the group 1 metals.

Put crosses (X) in TWO MORE boxes that are
group 1 metals.

X								

[1]

- (c) The teacher puts a small piece of sodium into a beaker of water.

State two things you would SEE happen in the beaker.

_____ [2]

- (d) David watches a firework display. He suspects that a firework contains sodium compounds. What is the clue that makes him suspect this?

Put a tick (✓) in the box next to the BEST answer.

The firework burns rapidly.

The firework makes a strong smell.

The firework produces grey smoke.

The firework burns with a yellow flame.

[1]

[Total: 6]

6 Bromine is a toxic and corrosive liquid.

(a) Which two safety symbols should be on bottles of bromine?

Put a ring around each of the TWO correct labels.



[1]

(b) The symbol for a bromine molecule is Br₂.

Which of these diagrams could be of a bromine molecule?

Put a ring around the correct answer.



[1]

(c) Bromine reacts with sodium to make sodium bromide.

Use the spaces to write a word equation for this reaction.

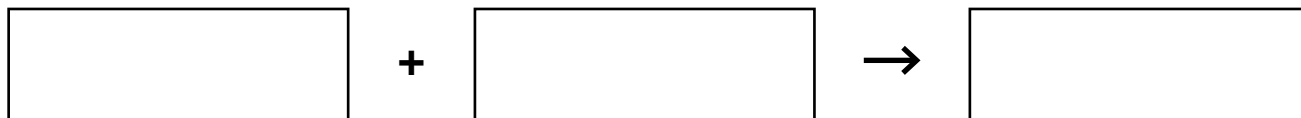

[1]

(d) Solid sodium bromide is ionic.

Draw ONE line between the boxes to describe what happens to the ions when solid sodium bromide dissolves in water.

Ions are in the solid at the start.

Ions then spread through the liquid.

OR

OR

Ions form when the solid dissolves.

Ions then sink to the bottom of the liquid.

[1]

[Total: 4]

7 Joe drives a bus along a level road.

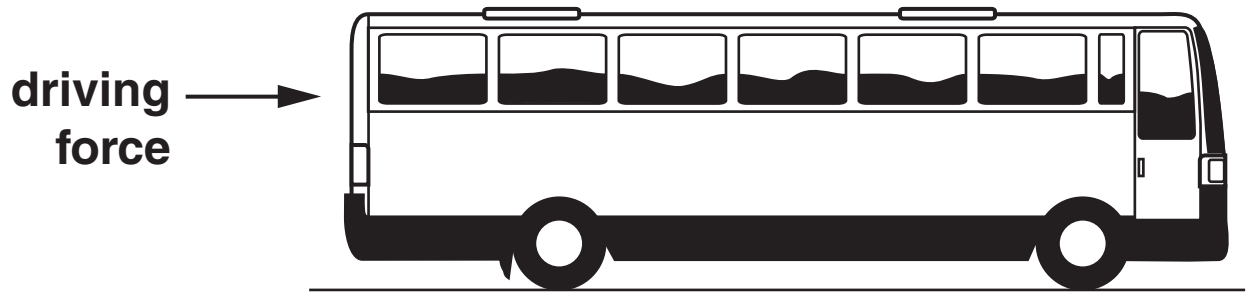

(a) A driving force acts forwards on the bus when it is moving at a steady speed.

Explain why the driving force does not increase the speed of the bus.

[2]

(b) On the axes below, sketch a DISTANCE-TIME graph for the bus as it travels at a steady speed of 15 m/s.

Start the graph at the point 0,0.

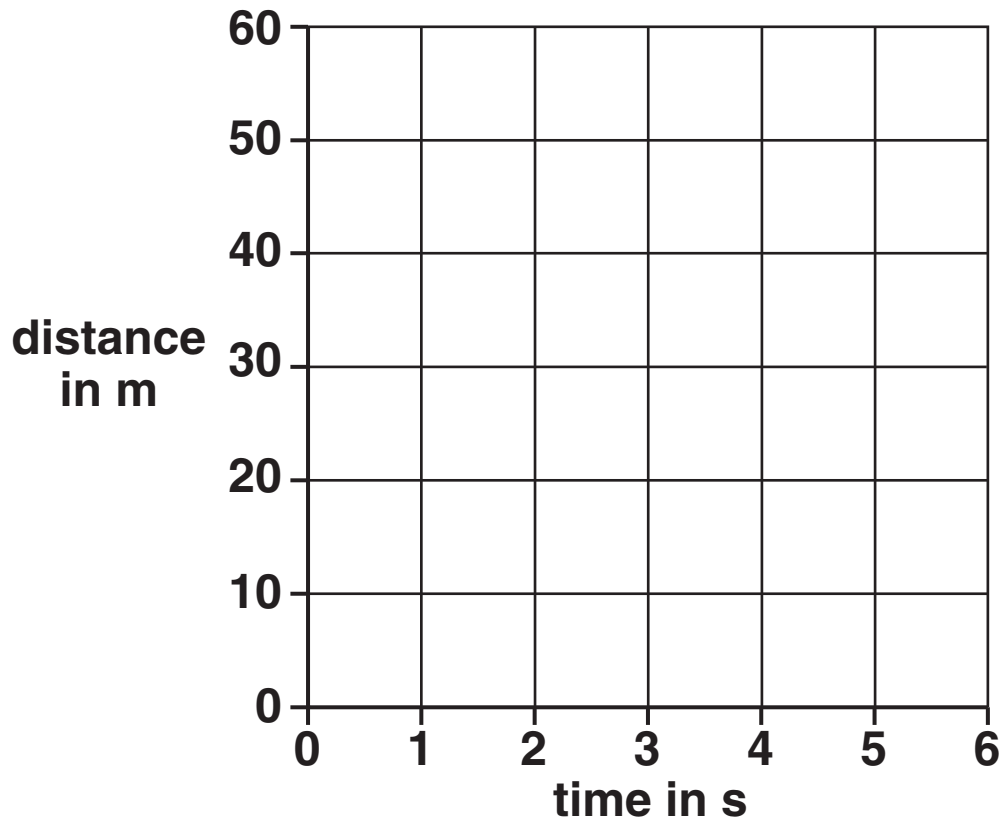

[2]

[Total: 4]

8 A small jet aircraft is speeding up along a runway.

(a) The engines exert a force of 6000 N on the aircraft as it moves along the runway.

Which calculation shows the change of momentum of the aircraft in 12 s?

Put a **ring** around the correct answer.

$$\frac{6000}{12}$$

$$6000 \times 12$$

$$\frac{12}{6000}$$

[1]

(b) Put a **ring** around the correct choice in each sentence.

The jet engines increase the forward speed of the aircraft.

The engines do this by pushing gas

BACKWARDS / FORWARDS.

The force needed on the gas is in the

BACKWARDS / FORWARDS direction.

This results in a force on the engines in the

SAME / OPPOSITE direction.

The force on the engines is GREATER THAN /

THE SAME AS / SMALLER THAN the force on

the gas.

[2]

(c) Which of these VELOCITY-TIME graphs shows a steadily increasing velocity?

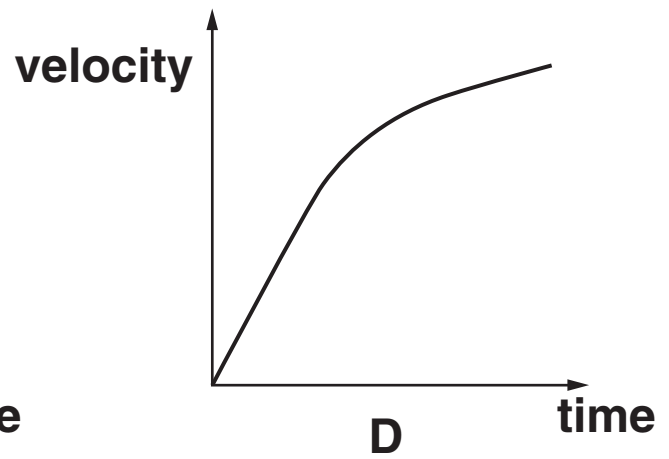
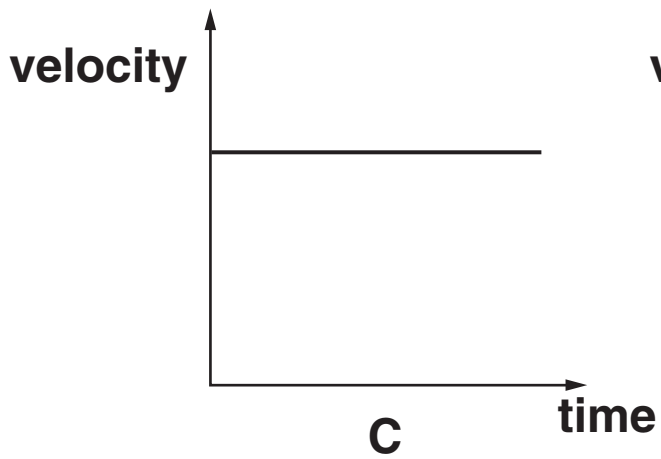
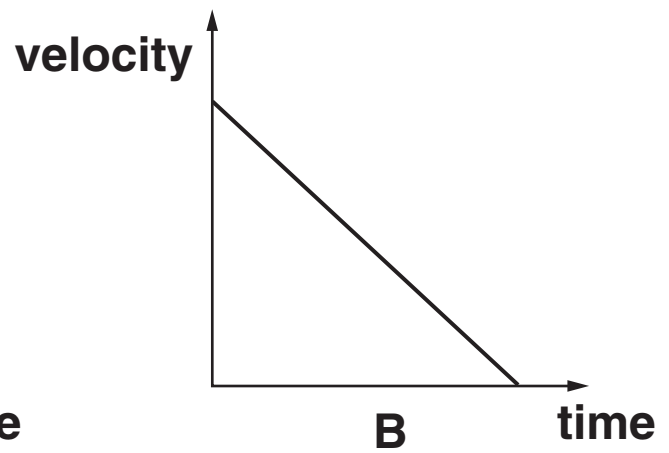
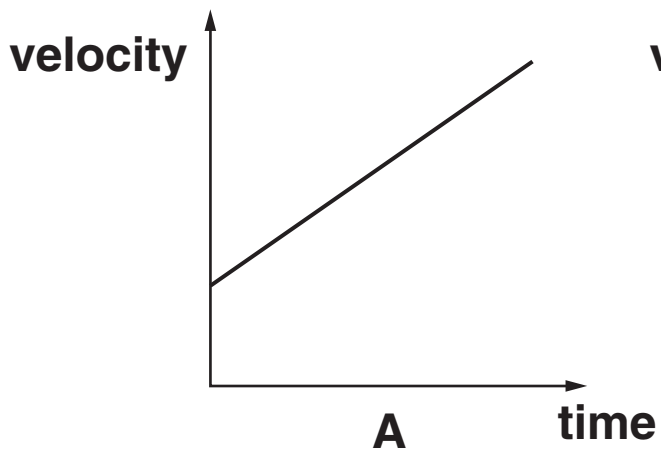

answer _____ [1]

(d) The aircraft takes off when it has a forward velocity of 48 m/s.

Put a tick (✓) in the box next to the correct meaning of the word VELOCITY.

The velocity of an object is ...

... how fast its speed is changing.

... its speed and direction of motion.

... how fast its direction is changing.

[1]

[Total: 5]

9 Jim takes part in a high jump contest.

(a) Complete the sentences.

Choose words from this list.

GRAVITATIONAL POTENTIAL

KINETIC

MOMENTUM

WORK

Jim stands 10m away from the high jump.

He runs towards the high jump, gaining

_____ energy.

He then jumps up to the bar, gaining

_____ energy.

[2]

(b) Jim has a mass of 65 kg. Just before he jumps up, his velocity is 10m/s.

Who has the correct way of calculating his momentum?

ALAN
 $\frac{1}{2} \times 65 \times 10^2$

CARLOS
 65×10

BESS
 $65 \times 10 \times 10$

DAVINA
 $\frac{1}{2} \times 65 \times 10$

answer _____ [1]

(c) Jim clears the bar and falls back to the ground.

Put a **ring** around the correct VELOCITY-TIME graph for Jim as he falls vertically to the ground.

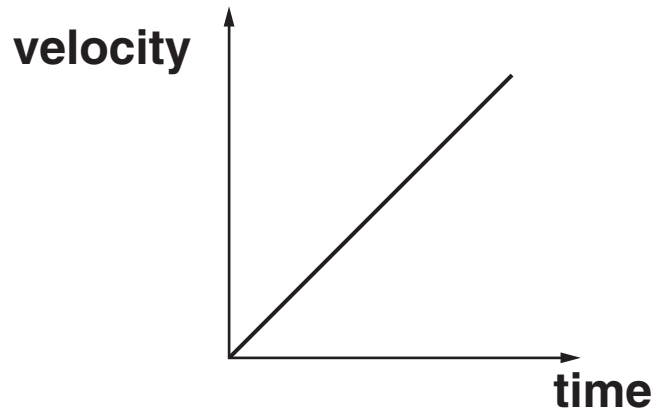
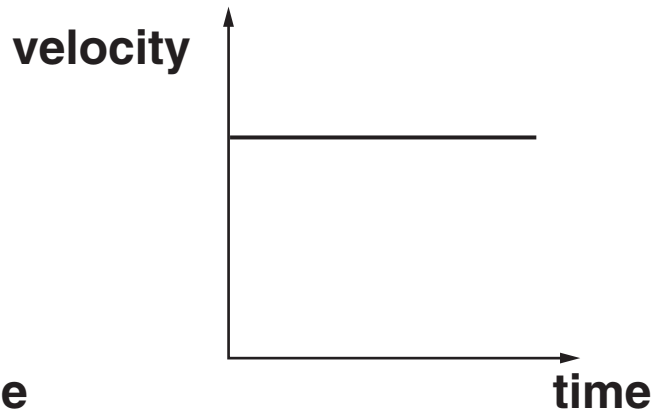
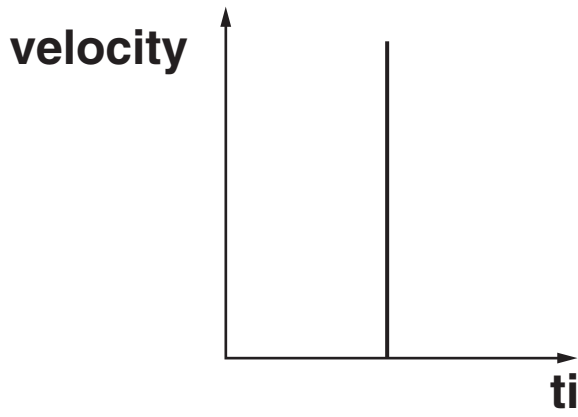

[1]

(d) Jim stops moving when he lands.

Put a tick (✓) in the box next to the correct statement.

His kinetic energy is lost through heating.

He gains momentum through friction.

He loses weight through reaction.

[1]

[Total: 5]

END OF QUESTION PAPER

BLANK PAGE



Copyright Information

OCR is committed to seeking permission to reproduce all third-party content that it uses in its assessment materials. OCR has attempted to identify and contact all copyright holders whose work is used in this paper. To avoid the issue of disclosure of answer-related information to candidates, all copyright acknowledgements are reproduced in the OCR Copyright Acknowledgements Booklet. This is produced for each series of examinations, is given to all schools that receive assessment material and is freely available to download from our public website (www.ocr.org.uk) after the live examination series.

If OCR has unwittingly failed to correctly acknowledge or clear any third-party content in this assessment material, OCR will be happy to correct its mistake at the earliest possible opportunity.

For queries or further information please contact the Copyright Team, First Floor, 9 Hills Road, Cambridge CB2 1GE.

OCR is part of the Cambridge Assessment Group; Cambridge Assessment is the brand name of University of Cambridge Local Examinations Syndicate (UCLES), which is itself a department of the University of Cambridge.

The Periodic Table of the Elements

	1	2	3	4	5	6	7	0										
	7 Li lithium 3	9 Be beryllium 4	11 Na sodium 11	12 Mg magnesium 12	13 Al aluminium 13	14 N nitrogen 7	15 P phosphorus 15	16 S sulfur 16	17 Cl chlorine 17	18 Ar argon 18								
	19 K potassium 19	20 Ca calcium 20	23 V vanadium 23	24 Cr chromium 24	25 Mn manganese 25	26 Fe iron 26	27 Co cobalt 27	28 Ni nickel 28	29 Cu copper 29	30 Zn zinc 30	31 Ga gallium 31	32 Ge germanium 32	33 As arsenic 33	34 Se selenium 34	35 Br bromine 35	36 Kr krypton 36		
	37 Rb rubidium 37	38 Sr strontium 38	39 Y yttrium 39	40 Zr zirconium 40	41 Nb niobium 41	42 Mo molybdenum 42	43 Tc technetium [98]	44 Ru ruthenium 44	45 Rh rhodium 45	46 Pd palladium 46	47 Ag silver 47	48 Cd cadmium 48	49 In indium 49	50 Sn tin 50	51 Sb antimony 51	52 Te tellurium 52	53 I iodine 53	54 Xe xenon 54
	55 Cs caesium 55	56 Ba barium 56	57 La* lanthanum 57	72 Hf hafnium 72	73 Ta tantalum 73	74 W tungsten 74	75 Re rhenium 75	76 Os osmium 76	77 Ir iridium 77	78 Pt platinum 78	79 Au gold 79	80 Hg mercury 80	81 Tl thallium 81	82 Pb lead 82	83 Bi bismuth 83	84 Po polonium 84	85 At astatine 85	86 Rn radon 86
	[223] Fr francium 87	[226] Ra radium 88	[227] Ac* actinium 89	[261] Rf rutherfordium 104	[262] Db dubnium 105	[266] Sg seaborgium 106	[264] Bh bohrium 107	[277] Hs hassium 108	[268] Mt meitnerium 109	[271] Ds darmstadtium 110	[272] Rg roentgenium 111	Elements with atomic numbers 112-116 have been reported but not fully authenticated						

1 H hydrogen 1

Key
relative atomic mass
atomic symbol
name
atomic (proton) number

* The lanthanoids (atomic numbers 58-71) and the actinoids (atomic numbers 90-103) have been omitted.

The relative atomic masses of copper and chlorine have not been rounded to the nearest whole number.