

# Eton College King's Scholarship Examination 2012

SCIENCE (SECTION 1)

(60 minutes)

Candidate Number: \_\_\_\_\_

## INSTRUCTIONS

*Write your candidate number, not your name, in the space provided above.*

*You should attempt ALL the questions. Write your answers in the spaces provided: continue on a separate sheet of paper if you need more space to complete your answer to any question.*

*Allow yourself about 12 minutes for each question.*

*The maximum mark for each question or part of a question is shown in square brackets.*

*In questions involving calculations, all your working must be shown.*

For examiners' use only.

1	2	3	4	5	TOTAL



1. The current in a circuit is measured in amperes. 1 ampere (A) corresponds to 1 coulomb of charge passing a point in one second.

a) Calculate the charge that flows through a resistor if a current of 0.2 A flows for 10 minutes. [1]



b) The current in a circuit is determined by the voltage of the source and the resistance of the circuit. The circuits below contain identical resistors and cells. The blank circles represent ammeters. Fill in the blank circles with the current reading on the ammeters. [6]

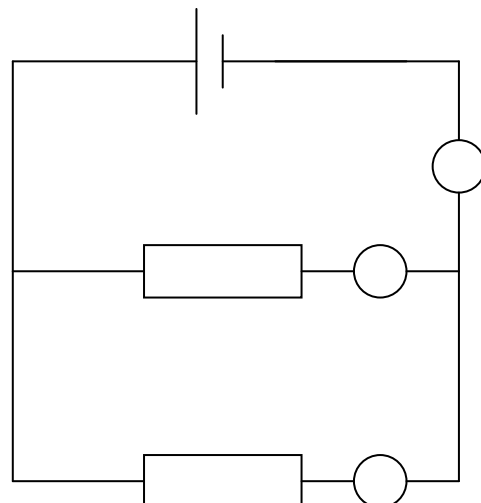
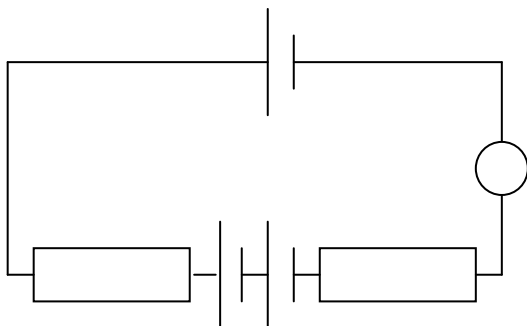
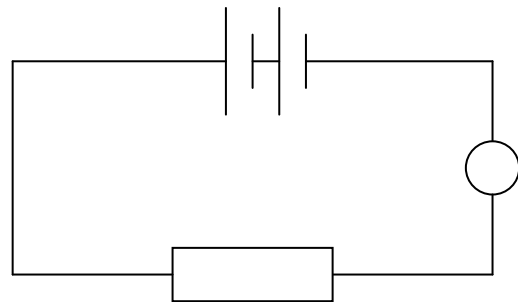
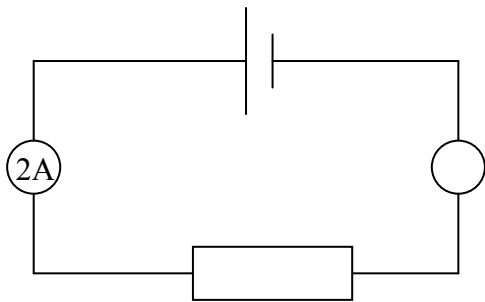

Consider the circuit below, which contains four LEDs. It is called a full wave rectifier and is one part of a circuit that converts alternating current (a.c.) to direct current (d.c.). The input current is plotted against time on the graph below the circuit. Positive values on the graph correspond to the current flowing clockwise and negative values correspond to the current flowing anticlockwise around the circuit.

- c) On the empty set of axes, plot the current against time as it flows between points X and Y in the circuit. The current should be taken as positive if it flows from X to Y, and negative if it flows from Y to X. [3]

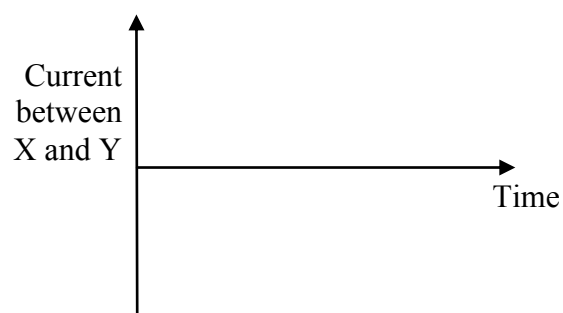
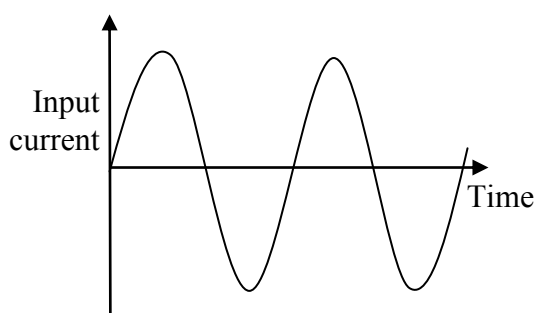
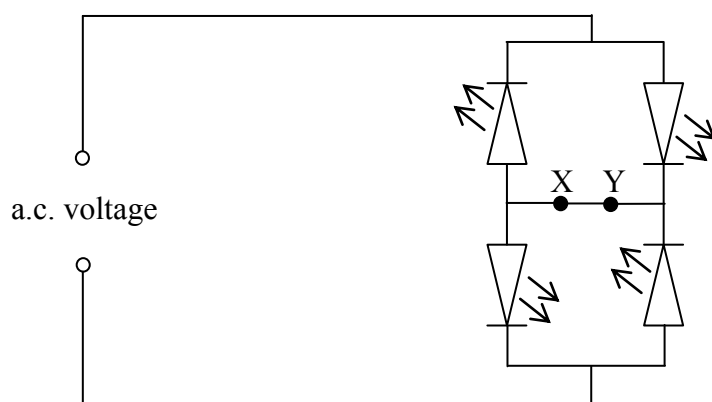

- i) A student wishes to get a visual idea of the current flowing between X and Y so he replaces the wire between X and Y with a fifth LED. You may assume that the LED has been correctly orientated. If the input current oscillates 50 times per second, how many times per second will the LED flash? [1]

---

- ii) Explain whether the student will be able to distinguish the individual flashes? [1]

---



---



2. When a large piece of ice breaks off a glacier into water it is known as an iceberg. The smallest icebergs, known as growlers, have a volume of less than  $5.0 \text{ m}^3$ .

Here are some data, which may help you in answering some of the questions below:

Density of seawater:  $1012 \text{ kg/m}^3$     Density of pure water:  $1000 \text{ kg/m}^3$     Density of ice:  $920 \text{ kg/m}^3$

- a) A floating object displaces a volume of water which has a mass equal to the mass of the floating object. With this information, calculate the percentage of a  $5.0 \text{ m}^3$  iceberg that is below the water line when it is floating in the sea. [3]

---



---



---

- b) A 120kg seal sits on top of an iceberg. What is the minimum volume of iceberg so that the seal is completely out of the seawater? *You may assume that the sea is perfectly calm.* [3]

---



---



---

- c) Objects in a liquid experience a force called buoyancy. In the picture below, an iceberg is floating stationary on the surface of the sea. Add arrows to show the direction of the two forces acting on the iceberg. Label each arrow with the name of the force it represents. [1]

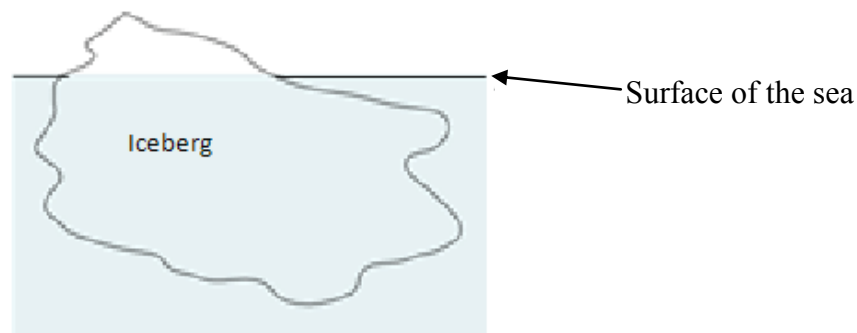

- d) A seal sitting on an iceberg slips off to go for a swim, so the iceberg then moves the seawater. Explain, with references to the size of forces on the iceberg, why it moves up. [1]

---

---

---

Even though the seawater, in which the iceberg floats, is above  $0^{\circ}\text{C}$ , the iceberg doesn't melt quickly. A student decides to find out how easy it is to melt ice. He discovers that the energy required to turn 1kg of ice at  $0^{\circ}\text{C}$  into 1kg of pure water at  $0^{\circ}\text{C}$  is 334000J. He also finds out that the energy required to change the temperature of 1kg of pure water by  $1^{\circ}\text{C}$  is 4200J.

- e) Hot water at  $70^{\circ}\text{C}$  is poured onto a block of ice so that it starts to melt. What is the minimum mass of water that is needed to melt a 500g piece of ice? [3]

---

---

---

---

---

- f) It turns out that more water is required to melt the ice. Suggest a reason for this. [1]

---

---

---



3. The excessive production of hydrochloric acid in the stomach can lead to indigestion. This can be relieved by antacid tablets. Scientists compared two market-leading brands of antacid tablet – brand A and brand B. The tablets contain a number of compounds, but the active ingredient in both brands is calcium carbonate.

a) What is the common name for calcium carbonate? [1]

---

The chemical equation for the reaction between calcium carbonate ( $\text{CaCO}_3$ ) and hydrochloric acid (HCl) is:



b) What name is given to this type of reaction? [1]

---

c) What will happen to the pH of the stomach acid when an antacid tablet is taken? [1]

---



A scientist carried out the following experiment in order to compare the activity of the two brands. He decided to measure the mass loss during the reaction above in which the hydrochloric acid (HCl) is in excess:

- $50\text{cm}^3$  of HCl with a concentration of  $0.1\text{ mol dm}^{-3}$  was measured out and transferred to a conical flask, which was then placed on a top pan balance;
- one tablet of brand A was crushed into a fine powder using a pestle and mortar and added to the conical flask;
- a cotton wool bung was immediately placed in the mouth of the flask and a stop watch started;
- the mass was recorded every 20 seconds for 10 minutes;
- the experiment was then repeated with one tablet of brand B of the exact same mass.

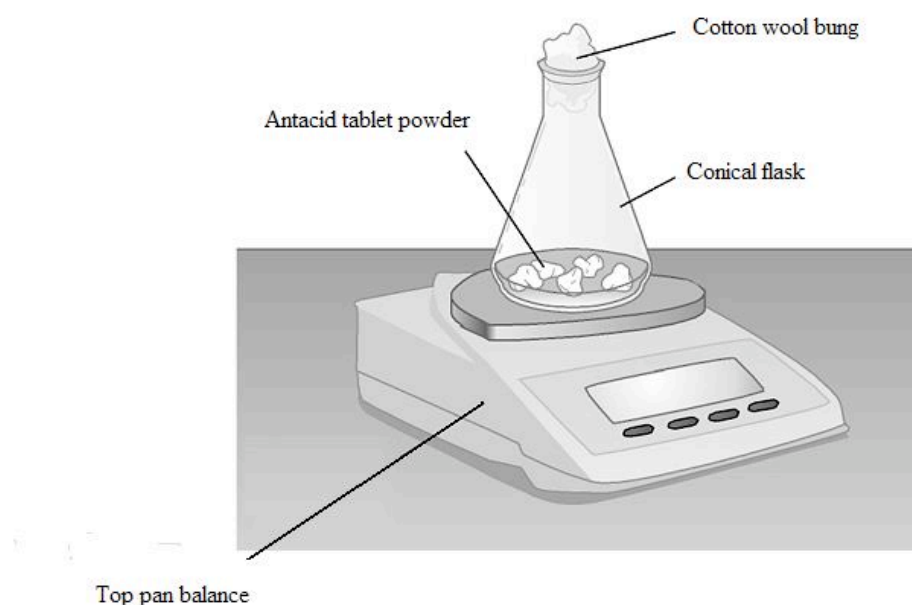

d) What does the term 'excess' mean and why is it needed? [2]

---

---

---

---

e) Name 2 factors (other than the mass of the two tablets) which needed to be kept constant in order to make the test fair. [2]

---



---



---

The results of the experiment for brand A are shown on the graph below:

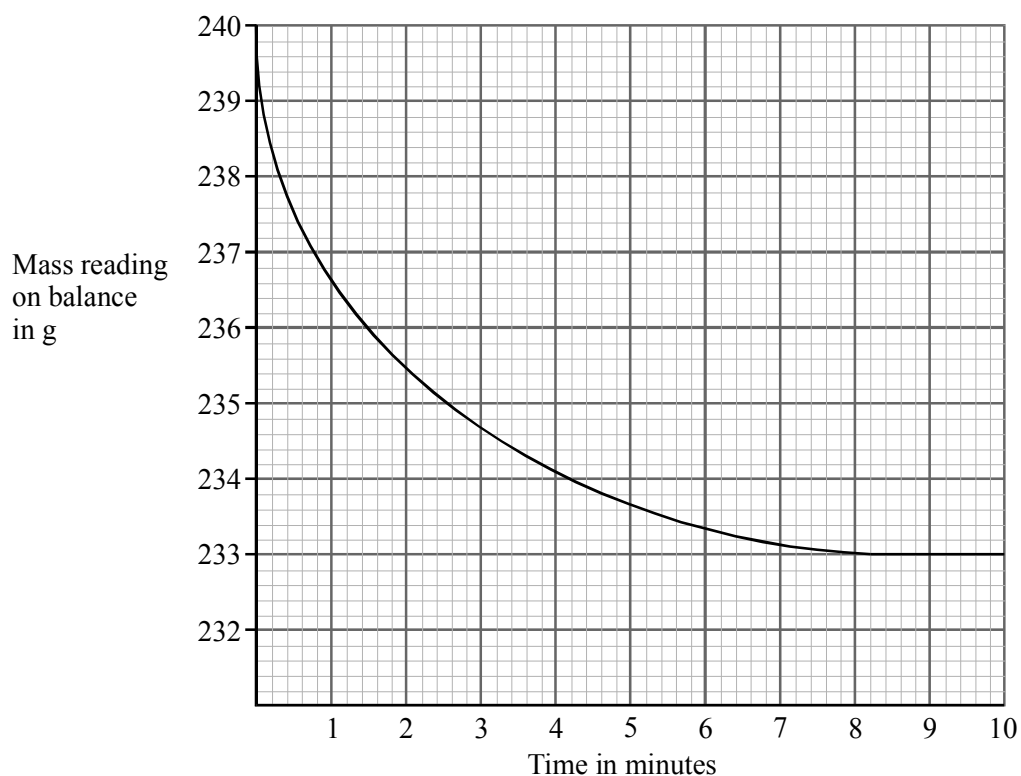

f) Describe and explain the shape of the curve. [3]

---



---



---



---

g) In a separate analysis of the two brands of antacid tablets, scientists found that brand A tablets had twice the mass of calcium carbonate compared to brand B. On the graph above sketch a likely curve for the experiment carried out on a brand B tablet. [2]





4.  $1000\text{cm}^3$  of water was weighed in all three of its states (solid, liquid and gas) and the densities found are listed in the table below.

State	A	B	C
Density $\text{g/cm}^3$	1.0000	0.9200	0.0006

- a) Explain, with reasons, which of A, B and C is the solid, liquid and gas. [3]

---

---

---

---

When pure ice that has been cooled to  $-5^\circ\text{C}$  is left out on a laboratory bench and its temperature monitored the following graph is obtained.

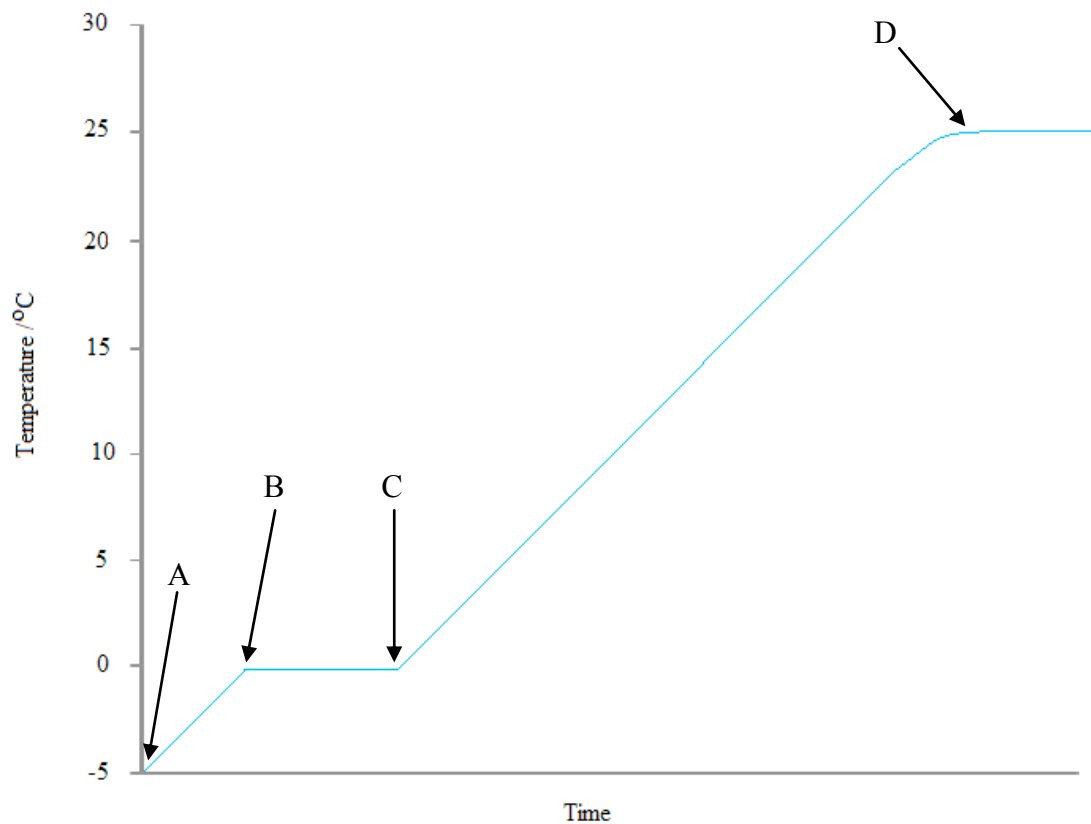

b) Using particle theory, explain why the temperature of the ice increases steadily between points A and B. [2]

---

---

---

c) What process is occurring between points B and C? [1]

---

d) Explain why the temperature stops increasing between points B and C before rising again between points C and D. Also explain why the temperature remains constant after point D. [3]

---

---

---

---

---

---

---

e) Water only boils at 100°C, yet when left overnight at room temperature the ice completely disappears. Explain this phenomenon. [3]

---

---

---

---

---



5. A scientist carried out an experiment to investigate the growth of yeast under different conditions. To do this he set up two conical flasks, and in each one he placed 1g of yeast, 500ml of distilled water, and 20g of growth medium (a mixture of sugars and other nutrients). This was stirred thoroughly to produce a suspension of yeast cells in a nutrient broth.

One flask was aerated (provided with an oxygen supply), while the other flask was not. All other experimental variables were kept the same.

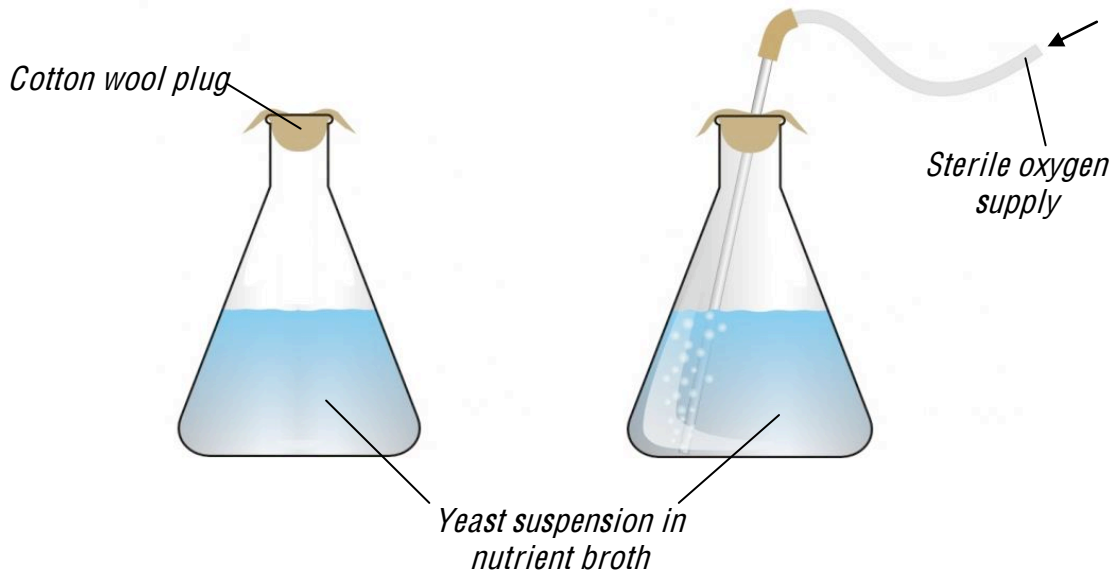

- a) Write down the word equation for aerobic respiration. [2]

---

---

- b) Suggest why respiration is important for the growth of yeast. [2]

---

---

---

---



To monitor the growth of the yeast cells, the scientist used a technique that enabled him to work out the mass of yeast present each day. He did this for 20 days, and the results are shown on the graph below:

**Effect of aeration on yeast growth**

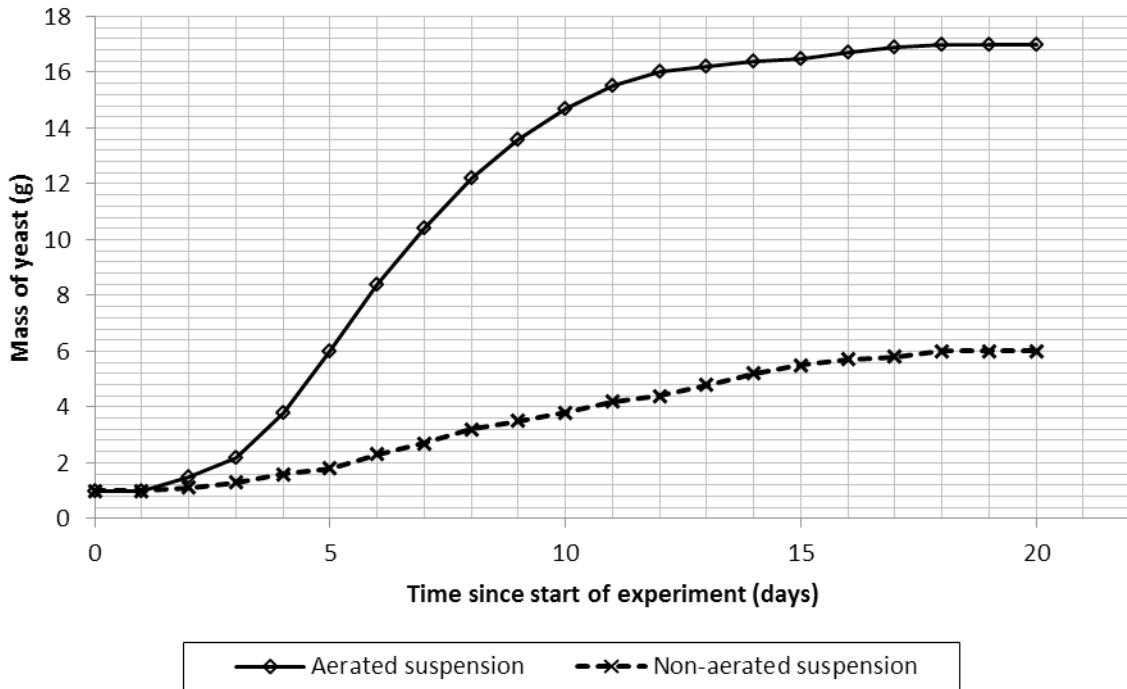

c) Suggest why the mass of yeast present did not change in either flask during the first day. [2]

---



---



---



---



d) Sketch a graph on the axes below to show how the growth rate of the aerated yeast varied during the experiment. [2]

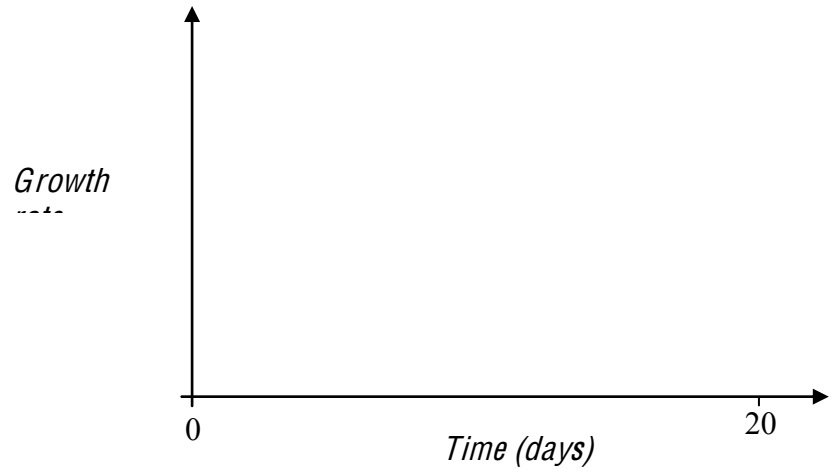

e) Suggest why at the end of the experiment the aerated yeast had stopped growing. [1]

---

---

f) The word equation for anaerobic respiration in yeast is as follows:

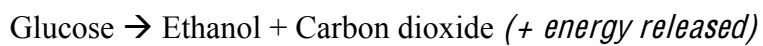

Using the above equation and your own knowledge, suggest why the final mass of yeast in the non-aerated flask was lower than that found in the aerated flask. [3]

---

---

---

---

---

---

---

---

[End of Paper]

