

BioMedical Admissions Test

Specimen Paper One hour

SECTION 1 Aptitude and Skills

Instructions to Candidates

Please read this page carefully, but do not open the question paper until you are told that you may do so.

A separate answer sheet is provided for this section. Please check you have one. You also require a soft pencil and an eraser.

Please first write your name, date of birth, BioMedical Admissions Test candidate number and centre number in the spaces provided on the answer sheet. Please write very clearly.

Speed as well as accuracy is important in this section. **Work quickly, or you may not finish the paper.** There are no penalties for incorrect responses, only points for correct answers, so you should attempt all 35 questions. Unless otherwise stated, all questions are worth one mark.

Answer on the sheet provided. Many questions ask you to show your choice between options by shading a circle (or circles, if specified in the question). If questions ask you to write in words or numbers, be sure to write clearly in the spaces provided. If you make a mistake, erase thoroughly and try again.

Any rough work should be done on this question paper.

Calculators are NOT permitted.

Please wait to be told you may begin before turning this page.

This paper consists of 17 printed pages and 3 blank pages.

BLANK PAGE

- 1 The graphs below show how the speeds of four different cars (P, Q, R and S) vary with time over a period of 10 seconds.

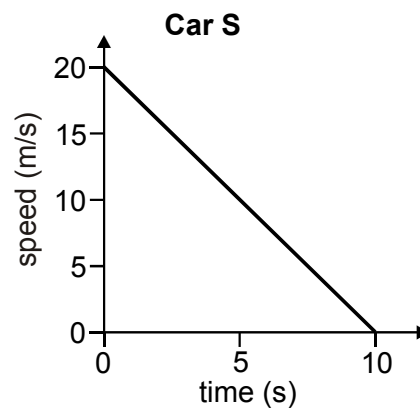
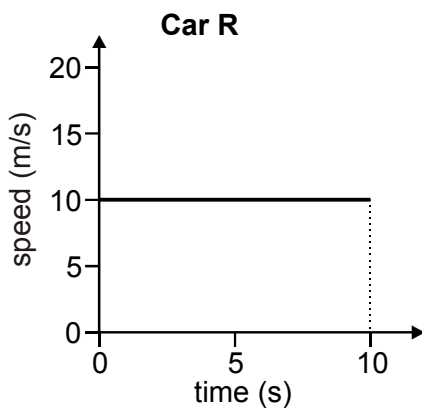
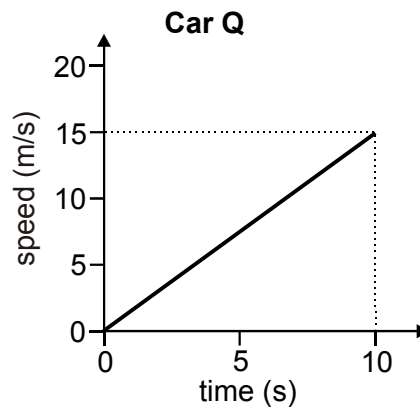
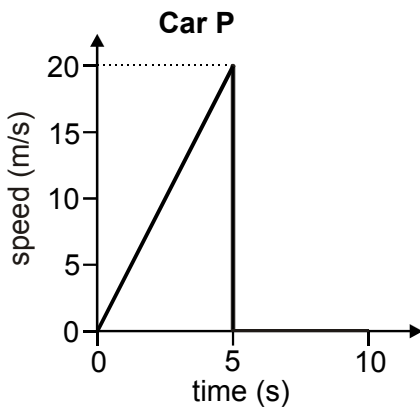

Which two cars travel the same distance in the 10 seconds?

- A** P and Q
B P and R
C Q and S
D R and S
- 2 Oakley is west of Carson, which is west of Newton. Earith is east of Carson and west of Wembourne.

Wembourne must be east of:

- A** Carson, but not necessarily east of Oakley or Newton;
B Newton, but not necessarily east of Carson or Oakley;
C Carson and Oakley, but not necessarily east of Newton;
D Oakley and Newton, but not necessarily east of Carson;
E Carson, Oakley and Newton.

- 3 A taxi company's fares consist of a flat rate for picking up a passenger plus a rate for each kilometre travelled.

It costs John £4 to go to the station, a distance of 5 km, and £3.20 to go to the town centre, a distance of 3 km.

How much would it cost him to go to the supermarket, a distance of 6 km?

- 4 The graph below shows how the flow rate in millilitres per second of fluid from a syringe into a patient's blood varies with time.

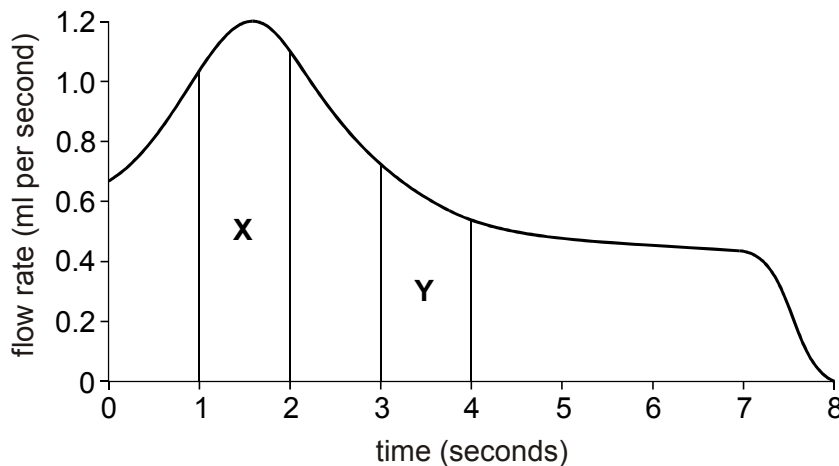

The area marked **X** on the graph is twice as large as the area marked **Y** on the graph. Which **two** of the following must be true?

- A** The rate of fluid flow after three seconds is half what it is after one second.
- B** The average rate of fluid flow is twice as great between one and two seconds as it is between three and four seconds.
- C** The flow rate increases twice as rapidly between one and two seconds as it does between three and four seconds.
- D** The amount of fluid flowing between one and two seconds is twice as much as the amount flowing between three and four seconds.
- 5 Every branchiopod is a crustacean and every crustacean is an arthropod. No insect is a crustacean. Which **two** of the following must be true?
- A** Every branchiopod is an arthropod.
- B** No insect is an arthropod.
- C** No branchiopod is an insect.
- D** Some crustaceans are insects.

- 6 The graph below shows the percentage of young women intending to vote at the next election compared with the figure for all ages of men and women.

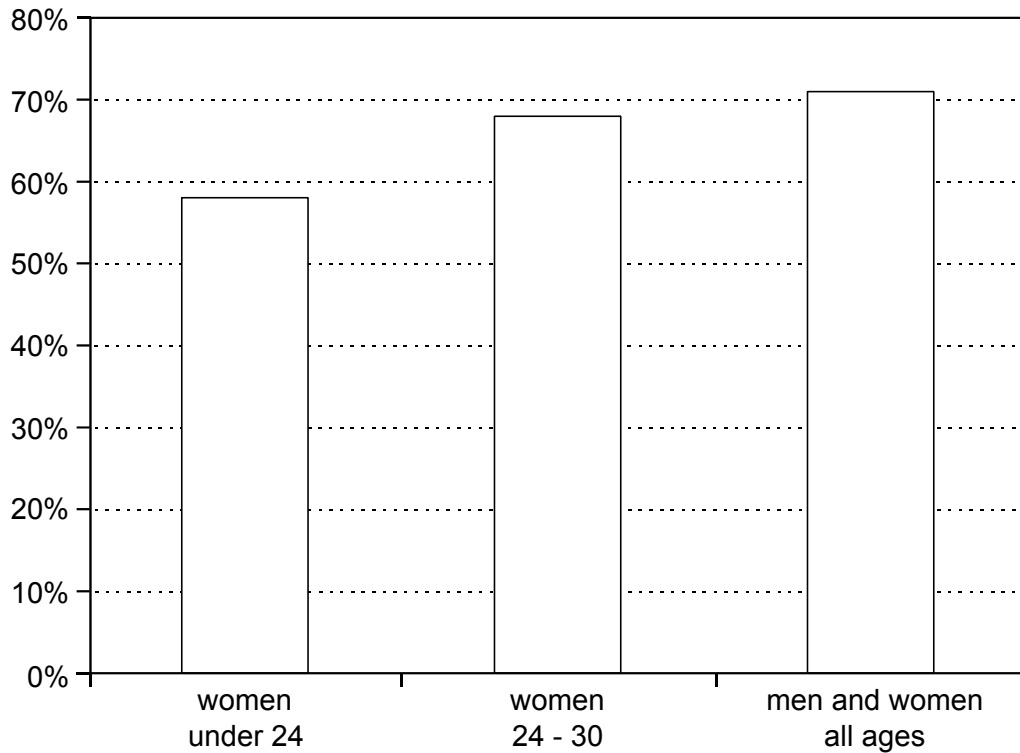

Which of the following statements can be deduced from the information provided?

- 1 Women are more likely to vote as they get older.
- 2 Women are less likely to vote than men.
- 3 Women are less likely to vote than at the last election.

- A** 1 and 2 only
B 2 and 3 only
C 1 and 3 only
D All
E None

- 7 The speed limit on motorways in the UK should be raised from 70mph to 80 mph. The majority of drivers consistently break the current speed limit - and without penalty, as the police are unable to enforce the speed limit in all cases. There is no evidence to suggest that driving at 80 mph is more dangerous than driving at 70 mph. If the speed limit were raised, the police could devote more time to dealing with other crimes.

Which **one** of the following, if true, most weakens the above argument?

- A** Many drivers choose to drive at below 70mph.
B Modern cars are capable of speeds far in excess of 80mph.
C Driving at 80mph uses more fuel than driving at 70mph.
D With a speed limit of 80mph, more drivers would drive between 80 and 90mph.

- 8 A government study suggested that courses in adult education should be subsidised because they contribute to the economy, raise skills and improve job opportunities. However where an adult education course is purely for leisure there is no case for subsidy. Therefore subsidies for courses which are purely for leisure should be abandoned.

Which **one** of the following is an underlying assumption of the above argument?

- A Unemployment figures are showing an upward trend.
- B Large numbers of adults will attend these courses.
- C There are enough teachers for the courses which would be subsidised.
- D Adults attending these courses will be able to upgrade their jobs if they pass the examinations.
- E Courses which are purely for leisure cannot be economically useful.

Questions 9 to 12 refer to the following information:

The bar chart below shows the reasons for people visiting their family doctors over a 12 month period to the nearest 5%. The chart shows the percentage of consultations due to each problem separately for men and women. The total annual consultation rates are 5 000 per 10000 men and 6000 per 10000 women. The proportion of men and women in the population may be assumed to be the same.

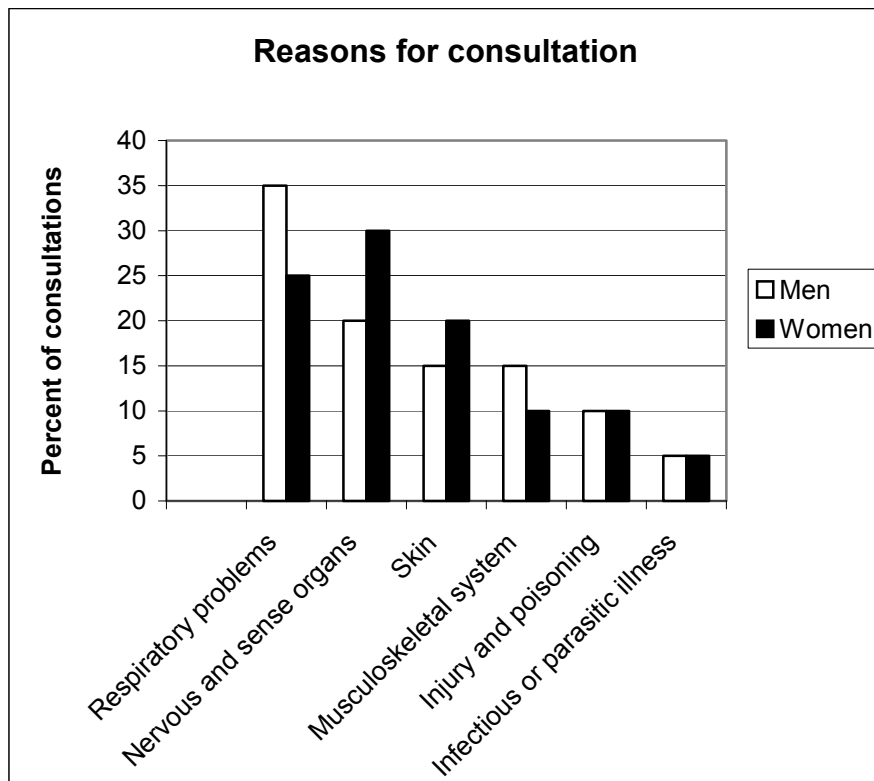

- 9 For both men and women, how many consultations per 10 000 per year are there for respiratory problems?
- A 1500
B 1625
C 1750
D 3250
E 3500
- 10 Which problems do men suffer from more than women by actual number of consultations? (Shade **all** that apply)
- A Respiratory problems
B Nervous and sense organs
C Skin
D Musculoskeletal system
E Injury and poisoning
F Infectious or parasitic illness
- 11 Which of the columns below correctly shows the number of consultations by women per 10000 per year for each disease?

	A	B	C	D	E
Respiratory problems	3500	1750	2500	1500	3250
Nervous and sense organs	2000	1000	3000	1800	2800
Skin	1500	750	2000	1200	1950
Musculoskeletal system	1500	750	1000	600	1350
Injury and poisoning	1000	500	1000	600	1100
Infections and parasitic illness	500	250	500	300	550

- 12 In which of the following pie charts is the proportion of consultations by disease for men correctly shown?

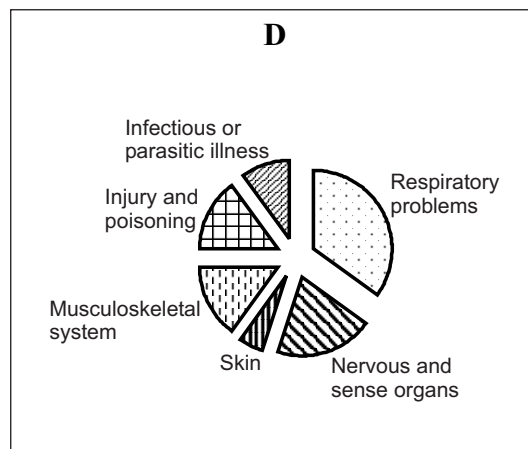
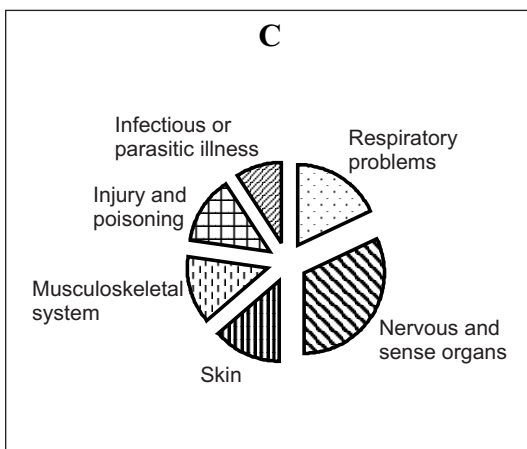
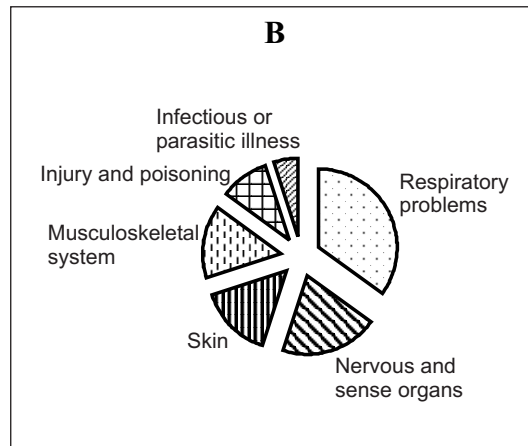
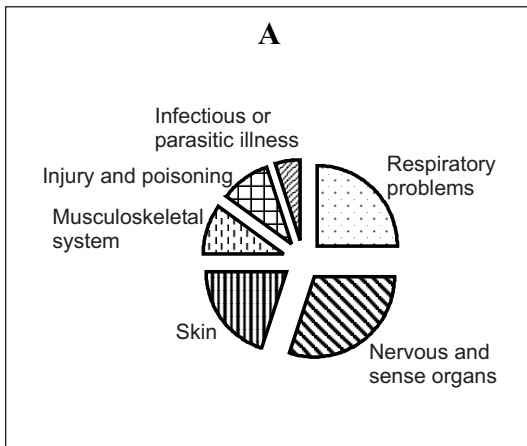

- 13 A man is 2 m tall. He treads bare-foot on a drawing pin. Nervous impulses travel from his foot to his brain via fast and slow nerve paths. In the fast paths the impulse velocity is 200 metres per second, in the slow paths it is 50 m/s. What is the time gap in milliseconds between the arrival of the two sets of impulses at the brain?

- A 10
 B 20
 C 30
 D 40
 E 50

- 14 If someone is suffering from influenza, they may have a sore throat or blocked nasal passages. Some, but not all, influenza sufferers with a sore throat also have blocked nasal passages. Some, but not all, influenza sufferers with blocked nasal passages also have a sore throat.

Which **one** of the options, **A** to **F**, correctly lists the following statements in order of their probabilities, giving the least likely first?

- 1 Someone suffering from influenza will have a sore throat.
- 2 Someone suffering from influenza will have a sore throat and blocked nasal passages.
- 3 Someone suffering from influenza will have a sore throat or blocked nasal passages.

- A** 1, 2, 3
B 1, 3, 2
C 2, 1, 3
D 2, 3, 1
E 3, 1, 2
F 3, 2, 1

- 15 A score board has to be able to show any score from 0 to 650. The score is shown by hanging plates on three hooks, each plate having a number painted on it on one side only (6 and 9 are **not** interchangeable). In the diagram below, the score shown is 60.

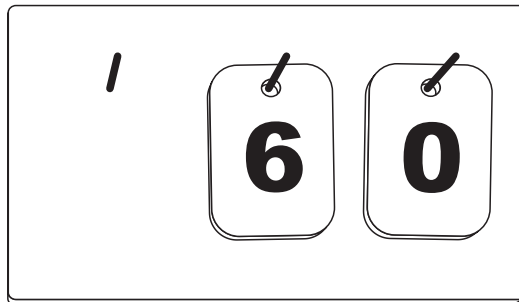

How many plates are necessary to show any score from 0 to 650?

- A** 25
B 26
C 27
D 30

- 16 Two buses, the Zipper and the Metbus, each pass my stop hourly, and I can catch either one. I have no regular times for travelling and I can never remember the bus times. I just go to the stop and catch the first bus that comes along. Yet I discover, over the year, the Zipper is more likely to come along first than the Metbus.

The Zipper passes the stop at z minutes past every hour and the Metbus passes at m minutes past. If the Zipper passes the stop in the first half of the hour, which **one** of the following would explain the higher probability of the Zipper coming along first?

- A $z > m$
- B $m > 30$
- C $z/m < 1$
- D $0 < (m-z) < 30$
- E $0 < (m-z) < 60$
- 17 In order to succeed in academic examinations it is necessary to study hard. Therefore if a student studies hard in a particular subject, that student should succeed in examinations in that subject.

Which **one** of the following is the best statement of the flaw in the above argument?

- A It assumes that students must study hard in order to succeed.
- B It overestimates the value of studying in preparation for examinations.
- C It ignores the fact that some examinations are more difficult than others.
- D It assumes that studying hard is a sufficient condition for academic success.
- E It ignores the fact that some students do not need to study hard in order to succeed.

- 18 The 400 seats in a parliament are divided amongst five political parties. No two parties have the same number of seats, and each has at least 20.

What is the largest number of seats that the third largest party can have?

- A 22
- B 118
- C 119
- D 120
- E 121

- 19 Four passengers, Ann, Bo, Cal and Dee have booked seats at one table on a train. Bo arrives first and sits in the seat reserved by Ann. Dee arrives next and sits diagonally opposite Bo. Ann arrives and insists on sitting in her reserved seat because she doesn't like facing backwards. She does so, and Bo moves to one of the other seats. Cal arrives just as the train is about to start and sits in the remaining seat.

Which of the following could show how the four passengers were sitting when the train started? (The arrows indicate the direction of travel.)

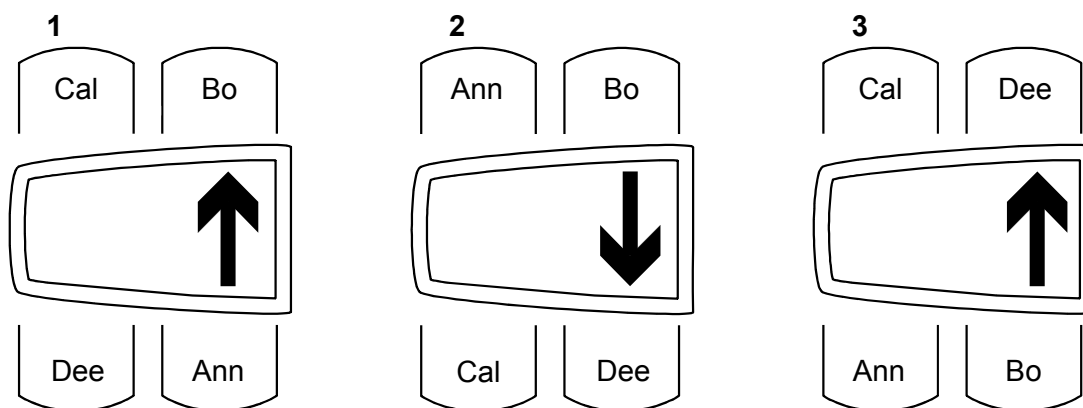

- A 1 only
 B 2 only
 C 3 only
 D 1 and 3 only
 E 2 and 3 only
- 20 Over the past 100 years there has been a rise in global average temperatures of 0.5°C . Because of this phenomenon of 'global warming' all coastal defences built in the future to protect Britain's most vulnerable regions from flooding should be of a different design to those currently employed, in order to allow for an annual increase in the sea level.

Which of the following are underlying assumptions of the above argument?

- 1 Global warming is likely to cause a rise in sea levels.
- 2 The trend of global warming is likely to continue.
- 3 Current coastal defences are likely to prove ineffective against rising sea levels.

- A 1 only
 B 1 and 2 only
 C 1 and 3 only
 D 2 and 3 only
 E 1, 2 and 3

Questions 21 to 24 refer to the following information:

A company making surgical appliances has premises on both sides of a street. The administrative offices are on the South side and the production unit is on the North side. Because of lack of office space, they decide to move the Technical Sales Consultant from the South side to the North side. The Warehouseman, who is a bit of a comedian, comments that this will cause the average salary to rise on both sides of the street and the average intelligence (I.Q.) to fall on both sides of the street

The employees' salaries and I.Q.s are shown in the table below (in their positions before the move).

South side (administration)			North side (production)		
Job no. and title	Salary (£)	I.Q.	Job no. and title	Salary (£)	I.Q.
01 Managing Director	70 000	140	07 Production Manager	42 000	160
02 Chief Accountant	55 000	145	08 Quality Technician	25 000	155
03 Accounts clerk	20 000	110	09 Production worker	20 000	130
04 Sales Director	40 000	130	10 Production worker	15 000	100
05 PA to MD	20 000	120	11 Development engineer	25 000	180
06 Technical Sales Consultant	35 000	135	12 Warehouseman	20 000	120
Total	240 000	780	Total	147 000	845

- 21 What is the average I.Q. on the South side of the road after the Technical Sales Consultant's move?
- A 129
B 130
C 140
D 141
- 22 By how much will the average salary on the North side of the road rise after the Technical Sales Consultant's move?
- A £1 000
B £1 500
C £3 500
D £5 000

23 If all the salaries rise by 5% next year, what will the total salary bill be?

- A £154 350
- B £252 000
- C £406 350
- D £425 700

24 The following scatter chart shows a best fit line for salary plotted against I.Q. Whose salary is furthest below the best fit line?

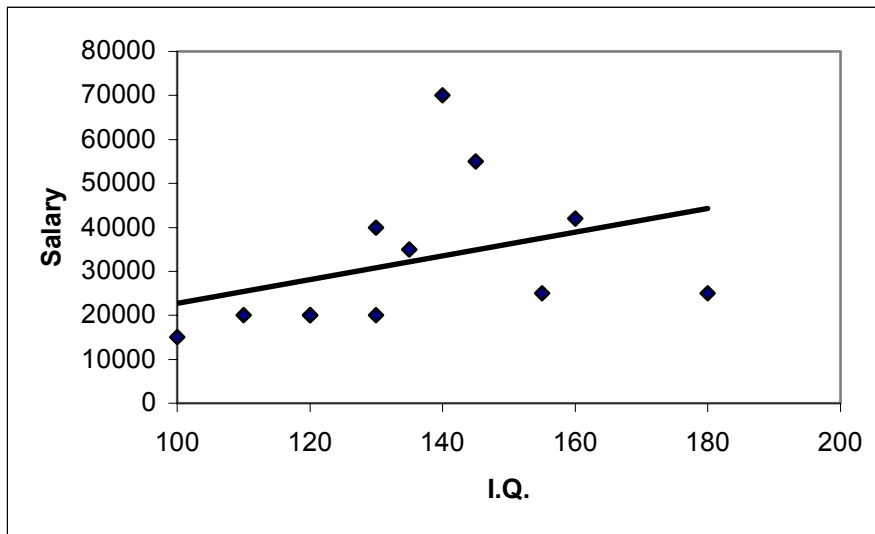

PLEASE TURN OVER

- 25** A code is expressed as a line of 5 colours in a particular order. The colours can be chosen from the following list: red, blue, green, grey, black, yellow and orange. A colour may only be used once in a code. Colours with the same initial letter are not permitted in the same code.

The first attempt to reproduce "Code X" was as follows:

1 red 2 green 3 blue 4 yellow 5 orange

It is known that 1,2 and 4 are correct, but that 3 and 5 are incorrect. Which **one** of the following attempts at Code X **may** be correct?

- A** 1 red 2 green 3 black 4 yellow 5 orange
B 1 red 2 green 3 blue 4 yellow 5 grey
C 1 red 2 green 3 orange 4 yellow 5 black
D 1 red 2 green 3 orange 4 yellow 5 grey
- 26** Several large scale trials have shown, at a very high level of statistical significance, that those who take no alcoholic drinks are more likely to suffer from heart disease than those who drink moderate amounts of alcohol. The researchers have concluded that a moderate intake of alcoholic drinks protects the body against heart disease.

Which **one** of the following is a reason why this conclusion might be unsafe?

- A** If enough trials are carried out, some will show statistical significance purely by chance.
B Those people drinking no alcohol may have other factors in their diet or lifestyle which increases their susceptibility to heart disease.
C A significant number of people refuse to answer questions about alcohol consumption.
D By-products of alcohol production other than alcohol itself may be the reason for the protection against heart disease.
- 27** In a class of 30 students all must study at least one language but no more than three languages. 70% study French, 40% study German, 20% study Spanish and 10% Italian.

Which **two** of the following statements must be true?

- A** At least 3 study both French and German.
B No more than 12 study French and German.
C At least 9 do not study either French or German.

- 28 Methods of financing health services in advanced industrial countries have little effect, statistically speaking, on the health of the population. There are countries which spend six times as much per head on health care as Britain, and countries which spend only half as much: their populations end up with more or less the same life expectancy. Therefore arguments about levels of financing Britain's National Health Service are largely irrelevant to the health of the population.

Which **one** of the following is an underlying assumption of the above argument?

- A The cost of Britain's health service is disproportionate to its effectiveness.
- B Spending is the most effective way of improving a health service.
- C Advanced industrial countries have failed to improve the health of their inhabitants.
- D Governments have a responsibility to organise efficient health care services.
- E Life expectancy is a reliable measure of the health of the population.

- 29 An allowance is reduced by 20%. The next year it is again reduced, by 25%. By what percentage must the allowance now be increased to reach its original level? Give your answer to the nearest whole number.

- 30 Jay always shops at Goodstuff. Kay shops at Goodstuff on weekdays but at weekends she shops at Stockup. Lee always shops at Stockup for food but at Fresco for all other goods.

One of the three sees the other pair of shoppers coming out of one of the shops where they have both been buying food.

Which **one** of the following **cannot** be true?

- A It's a weekday.
- B It's a weekend and the shop is Stockup.
- C The shop is Goodstuff and one of the pair of shoppers is Kay.
- D It's a weekend and the shop is Goodstuff.
- E It's a weekend and neither of the pair of shoppers is Jay.

- 31** Over a period of time, a doctor has appointments with 2400 different patients. 40% of the patients are male, and 70% of the female patients are 50 years of age or over. On average, 1 in 20 of all patients cancels an appointment. Assuming all patients are equally likely to cancel their appointments, what is the most likely number of female patients less than 50 years old who cancel? (To the nearest whole number.)
- A** 18
 - B** 20
 - C** 22
 - D** 42
 - E** 44

PLEASE TURN OVER

Questions 32 to 35 refer to the following information:

Comparing cannabis with tobacco

Smoking cannabis, like smoking tobacco, can be a major public health hazard

Britain now has 13 million tobacco smokers. This number has been steadily decreasing due to public awareness of the harm caused by tobacco smoking. At the same time the number of cannabis smokers is increasing. Between 1999 and 2001, the number of 14-15 year olds who had tried cannabis rose from 19% to 29% in boys and 18% to 25% in girls, and a Home Office document estimates that 3.2 million people in Britain smoke cannabis. However, the harmful effects of smoking cannabis are widely known and have recently been highlighted. Although the active ingredients of the cannabis plant differ from those of the tobacco plant, each produces about 4000 chemicals when smoked and these are largely identical. Although cannabis cigarettes are smoked less frequently than nicotine cigarettes, their mode of inhalation is very different. Compared with smoking tobacco, smoking cannabis entails a two thirds larger puff volume, a one third larger inhaled volume, a fourfold longer time holding the breath, and a fivefold increase in concentrations of carboxyhaemoglobin. The products of combustion from cannabis are thus retained to a much higher degree. How is this likely to translate into adverse effects on health?

We already know that regular use of cannabis is associated with an increased incidence of mental illnesses, most notably schizophrenia and depression, but it is also worth examining its potential to cause other illnesses, especially those of the heart and respiratory system.

At present, there is an understandable dearth of epidemiological evidence of cardiopulmonary harm from cannabis, because its use is a relatively new phenomenon and its potency is changing. The amount of the main active constituent, tetrahydrocannabinol (THC), in cannabis has increased from about 0.5% 20 years ago to nearer 5% at present in Britain, whereas "Nederweed" (the variety smoked in the Netherlands) has an average of 10-11% tetrahydrocannabinol. At the same time little study has been undertaken of any concomitant change in the content of tar. Case-control studies are difficult to perform since cannabis cigarettes do not come in standard sizes, which makes dose-response relations difficult to establish. Furthermore, most users of cannabis also smoke tobacco, which makes it difficult to dissect out individual risks. As with tobacco, there will be a latent period between the onset of smoking and the development of lung damage, cardiovascular disease, or malignant change.

Tobacco smoking is responsible for 120 000 excess deaths each year in Britain, 46 000 from

cancers, 34 000 from chronic respiratory disorders, and 40 000 from diseases of the heart and circulation. However, there are indications that smoked cannabis may cause similar effects to smoking tobacco, with many of them appearing at a younger age. Smoking cannabis causes chronic bronchitis, emphysema, and other lung disorders, which were recently summarised in a review released by the British Lung Foundation. A striking feature of cannabis smoking is that it is associated with bullous lung disease in young people. Inflammatory lung changes, chronic cough, and chest infections are similar to those in cigarette smokers, but may also be commoner in younger people. Premalignant changes have been shown in the pulmonary epithelium, and there are reports of lung, tongue, and other cancers in cannabis smokers.

Tetrahydrocannabinol has cardiovascular effects, and sudden deaths have been attributed to smoking cannabis. Myocardial infarction is 4.2 times more likely to occur within an hour of smoking cannabis. However, despite these alarming facts, there is no evidence at present on whether smoking cannabis contributes to the progression of coronary artery disease, as smoking cigarettes does. More studies of the cardiovascular and pulmonary effects of cannabis are essential.

It may be argued that the extrapolation from small numbers of individual studies to potential large scale effects amounts to scaremongering. For example, one could calculate that if cigarettes cause an annual excess of 120 000 deaths among 13 million smokers, the corresponding figure for deaths among 3.2 million cannabis smokers would be 30 000, assuming equality of effect. Even if the number of deaths attributable to cannabis turned out to be a fraction of that figure, smoking cannabis would still be a major public health hazard. However, when the likely mental health burden is added to the potential for morbidity and premature death from cardiopulmonary disease, these signals cannot be ignored. A recent comment said that prevention and cessation are the two principal strategies in the battle against tobacco. At present, there is no battle against cannabis and no clear public health message.

John A Henry, *professor*.

Academic Department of Accident and Emergency Medicine, Imperial College School of Medicine, St Mary's Hospital, London W2 1NY (j.a.henry@ic.ac.uk)

William L G Oldfield, *specialist registrar*.

Onn Min Kon, *consultant*.

Department of Respiratory Medicine, St Mary's Hospital

Henry JA, Oldfield WLG & Kon OM. Comparing cannabis with tobacco. *BMJ*, 2003; 326: 942-3.
Reproduced with permission from the BMJ Publishing Group.

Answer the following questions, assuming that the information above is accurate.

- 32 Which of the following statements may we safely conclude to be accurate?
- A Smoking cannabis is less harmful than smoking tobacco because it occurs less frequently.
 - B Smoking cannabis is equally harmful to smoking tobacco because largely identical chemicals are produced.
 - C Smoking cannabis is more harmful than smoking tobacco because the products of combustion are retained to a higher degree.
 - D Cannabis smokers often smoke tobacco, incurring harm produced by both.
- 33 The authors are suggesting that the dangers of smoking cannabis should be publicised primarily because:
- A it is associated with mental illness;
 - B of the danger to young people;
 - C the effects of widespread use by younger people will only appear in years to come;
 - D of the extent of the public health risk.
- 34 Which of the following do NOT contribute to the difficulty in determining what damage to the heart and lungs is caused by smoking cannabis?
- 1 the fact that few people smoke cannabis
 - 2 the varying potency of cannabis cigarettes
 - 3 the appearance of effects from cannabis at a younger age
- A 1 & 2
 - B 1 & 3
 - C 2 & 3
 - D 1, 2 & 3
- 35 If the percentage annual rise between 1999 and 2001 were to continue, what percentage of all young people aged 14-15 might be expected to have tried cannabis by 2005?
- A approximately 36%
 - B approximately 39%
 - C approximately 44%
 - D approximately 49%

END OF SECTION 1

BLANK PAGE

BLANK PAGE