

ResultsPlus

Examiners' Report June 2010

GCE Design and Technology 6RM02

ResultsPlus
look forward to better exam results
www.resultsplus.org.uk

Edexcel is one of the leading examining and awarding bodies in the UK and throughout the world. We provide a wide range of qualifications including academic, vocational, occupational and specific programmes for employers.

Through a network of UK and overseas offices, Edexcel's centres receive the support they need to help them deliver their education and training programmes to learners.

For further information, please call our GCE line on 0844 576 0025, our GCSE team on 0844 576 0027, or visit our website at www.edexcel.com. If you have any subject specific questions about the content of this Examiners' Report that require the help of a subject specialist, you may find our **Ask The Expert** email service helpful.

Ask The Expert can be accessed online at the following link:

<http://www.edexcel.com/Aboutus/contact-us/>

ResultsPlus

ResultsPlus is Edexcel's free online tool that offers teachers unrivalled insight into exam performance.

You can use this valuable service to see how your students performed according to a range of criteria - at cohort, class or individual student level.

- Question-by-question exam analysis
- Skills maps linking exam performance back to areas of the specification
- Downloadable exam papers, mark schemes and examiner reports
- Comparisons to national performance

For more information on ResultsPlus, or to log in, visit www.edexcel.com/resultsplus.

To set up your ResultsPlus account, call 0844 576 0024

June 2010

Publications Code US023749

All the material in this publication is copyright
© Edexcel Ltd 2010

Introduction

It was pleasing to see in the second year of this specification that centres had obviously taken on board the advice given at feedback. Fewer candidates were straying 'out of clip' with their answers and more candidates seem to be planning their answers before attempting them (especially the longer answers, which require structuring).

However, all centres/candidates should be aware of the meaning of the trigger words which start a question. A list of the words used are published in the available support material. Understanding the command words will help candidates to structure their answers appropriately as some candidates (who were clearly knowledgeable about a topic being questioned), strayed from the 'thrust' of the question, thus dropping marks.

Candidates were better at keeping their responses within the allocated space on the question paper, therefore reducing the 'excessive' answers seen in previous years.

Candidates are also encouraged to use more correct technical vocabulary in their answers as far too many answers are still limited to 'general' descriptions of processes and procedures.

The quality of sketching is generally very poor for A-level candidates and centres should spend some time on improving it.

Question 1 (a)

This question was designed to test the candidates understanding of the vacuum forming process and the necessary design considerations which must be addressed if the mould is to be successful.

1 Figure 1 shows a mould which is used for vacuum forming.

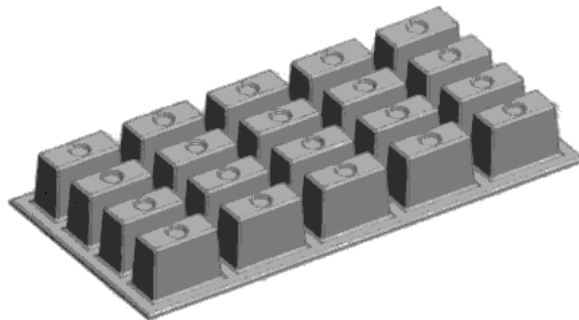
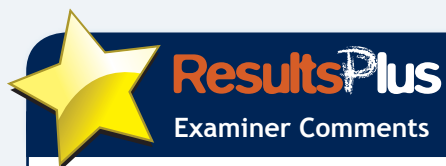

Figure 1

(a) Give **four** features of a mould which must be considered in order to create a successful vacuum forming.

(4)

The example of a mould used in this question represented something like an ice cube tray or a chocolate box interior and was used to help the candidates visualise the problems. However, the question just asks for features of a mould and candidates do not have to answer specifically about this mould.



Some candidates read more into the question by assuming that the forming would be separated into 20 individual formings by 'sawing/cutting' them apart after the forming was complete. This caused them to lose marks as they gave answers which no longer focussed on how to create a mould which would give successful formings.

Question 1 (b)

This question tested the candidates understanding of the various stages involved in the process of vacuum forming.

(b) Describe, using notes and/or sketches, the vacuum forming process.

(6)

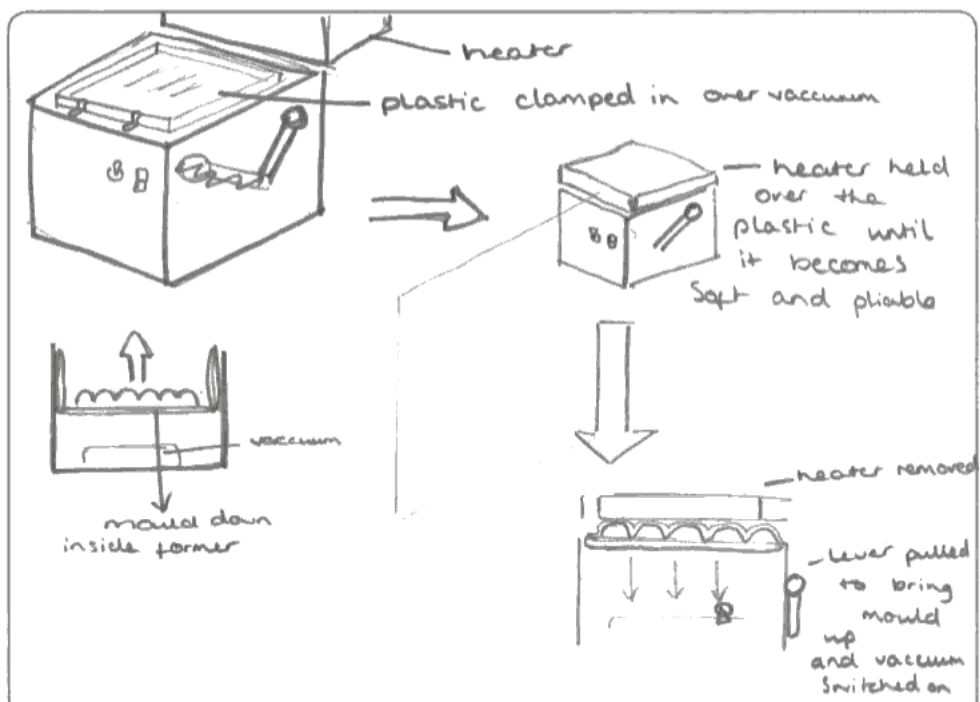

MDF
The mould would be placed on the wire gauze and released
down into the former.
A sheet of plastic (polystyrene) would be
clamped into the former by the bracket,
ensuring there are no gaps around the outside.
The heater would then be moved over the plastic and
moved until it becomes soft and pliable. The heater
would then be removed, the mould brought
up and the vacuum switched on to cool the
plastic and wrap it tightly around the mould.
Once the plastic has cooled the vacuum may
be put into reverse to blow and help release the
mould from the forming.

(Total for Question 1 = 10 marks)

Questions like this give the candidate an opportunity to answer either with diagrams and/or text and score full marks whichever way they choose.



ResultsPlus

Examiner Comments

This candidate has chosen to use both diagrams and text. They have also used good clear diagrams, in both 2d and 3d. The annotation is clear.



ResultsPlus

Examiner Tip

Because the description of a process like vacuum forming is a linear process, bullet points make the text even clearer and help the candidate to show the order of the process more clearly

Question 2 (a)

This question gives the candidate a chance to describe the process of brazing using as many of the correct technical terms as possible.

A bulleted format would help the candidate organise their answer and also help to show the processes in the correct order. Many candidates clearly start writing and then realise they have missed something out. This often leads to items being 'out of clip' or a very jumbled, difficult to read answer.

2 Figure 2 shows two mild steel tubes which have been brazed together.

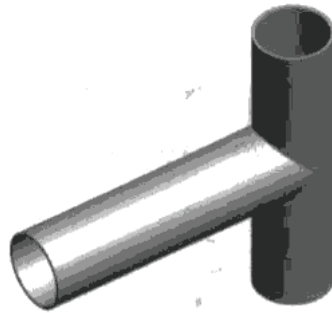

Figure 2

(a) Describe the process of brazing the two tubes together.

(4)
 Firstly ~~on flux~~ the tubes will need to be cleaned up, and then a flux will be applied to the area being brazed. The flux prevents ~~the~~ oxides forming on the surface of the metal, therefore causing a weak joint. Then a spelter is put in between the two materials, heat is applied and the two metals join together. The flux also allows the spelter to flow between the two materials.



ResultsPlus

Examiner Comments

This answer clearly shows the candidate's understanding of the process as they use the correct terminology e.g. flux and spelter and have the sequence of processes in an acceptable order.



ResultsPlus

Examiner Tip

A bulleted format would help the candidate organise their answer and also help to show the processes in the correct order. Many candidates clearly start writing and then realise they have missed something out. This often leads to 'items out of clip' or a very jumbled, difficult to read, answer

Question 2 (b)

This question was concerned with the applications and processes involved with the use of a contact adhesive for a given situation.

Candidates were asked to explain two reasons and then describe the process.

(b) Figure 3 shows a plywood seat for a chair which requires a decorative veneered finish. The veneer is a thin wooden layer (laminate) that is to be bonded to the surface of the plywood seat using contact adhesive.

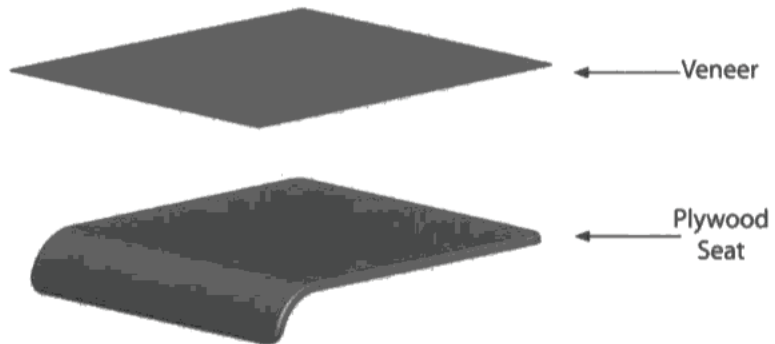

Figure 3

(i) Explain **two** reasons why contact adhesive is suitable for this purpose.

(4)

- 1 The contact adhesive will glue the veneer around the curve ~~see~~ section of the seat, with the aid of a vacuum or a mould or clamps. The adhesive is applied on both materials and left to dry, they are contacted and taped to cure the glue.
- 2 Contact adhesive is fast drying, therefore there will be no need for clamps. Contact adhesive is also very strong and will keep the veneer in place, without it peeling off.

(ii) Describe the process of using contact adhesive to bond the veneer to the chair seat.

(2)

The contact adhesive is applied on both contacting sides of material, and left to dry. When dry they are positioned on top of each other and pressed down. After light hammering is required to start the bonding process.

(Total for Question 2 = 10 marks)



ResultsPlus

Examiner Comments

Although this candidate goes on to show a good understanding of contact adhesives in the later part of the question and scores full marks for the rest of the answer, section b(i) has the candidate using clamps or a vacuum bag which tends to suggest a lack of understanding of the 'instant' bond principle of contact adhesive.

Question 3 (a)

This question was designed to illicit answers and related responses about Health and Safety issues regarding a number of processes.

Candidates were expected to choose a hazard which related to the given situation and then give a control measure which related to their chosen hazard. A number of candidates however did not relate their control measure to their chosen hazard.

Also, several candidates gave incorrect answers for the third hazard as they gave answers relating to CAM, and not CAD.

3 (a) It is necessary for companies to carry out risk assessments for all processes.
Identify **one** hazard and **one** control measure for each of the following processes

(i) Wood turning (2)

Hazard

Eye Eyes - Dust from the wood could enter the eyes or nose.

Control measure

Wear safety goggles and a dust mask.

(ii) Metal casting (2)

Hazard

Skin burn - The metal being worked could get hot.

Control measure

Wear protective heat proof gloves and apron.

(iii) Computer Aided Designing

(2)

Hazard

Muscle Cramp ~~because~~ due to lack of movement in the wrist and hand when ~~use~~ using a mouse.

Control measure

Use an ergonomic mouse and take regular breaks.



ResultsPlus

Examiner Comments

This candidate has used good, related answers for each of the hazards.



ResultsPlus

Examiner Tip

The candidate has written their answer in a succinct manner which makes the answer easy to follow.

Question 3 (b)

This question was concerned with altering the properties of a material by the use of heat-treatments. Candidates were expected to be able to explain the reasons for hardening and tempering the given example and then describe how the process is carried out.

(iii) Describe the process of tempering steel. (2)

The steel is heated to a certain colour, each colour the steel goes through means that some hardness and brittleness is being taken away and the toughness improved.

(Total for Question 3 = 12 marks)

This clip has been used to illustrate the range of words it is possible to score marks with.



ResultsPlus

Examiner Comments

biii) the candidate has been awarded 2 marks as the answer shows a clear understanding of the need to heat the metal to a specific temperature and also that there is a colour change which relates to the temperature.



ResultsPlus

Examiner Tip

The use of good technical language can help candidates to score marks as it helps examiners to understand the level of knowledge the candidate has.

Question 4 (a)

This question gives an artifact which uses rivets to fasten the corners together. Candidates were expected to describe the process using correct technical language/diagrams.

Candidates were expected to show:

- i a suitable rivet type
- ii support for the rivet head
- iii the rivet being rounded over
- iiii the head being suitably shaped

Many candidates described the use of pop rivets which scored no marks. Some candidates described pop rivets, but added that they could then be hit with a hammer. This also scored no marks.

(a) Describe, using notes and/or sketches, the process of riveting using snap (head) rivets.

(4)

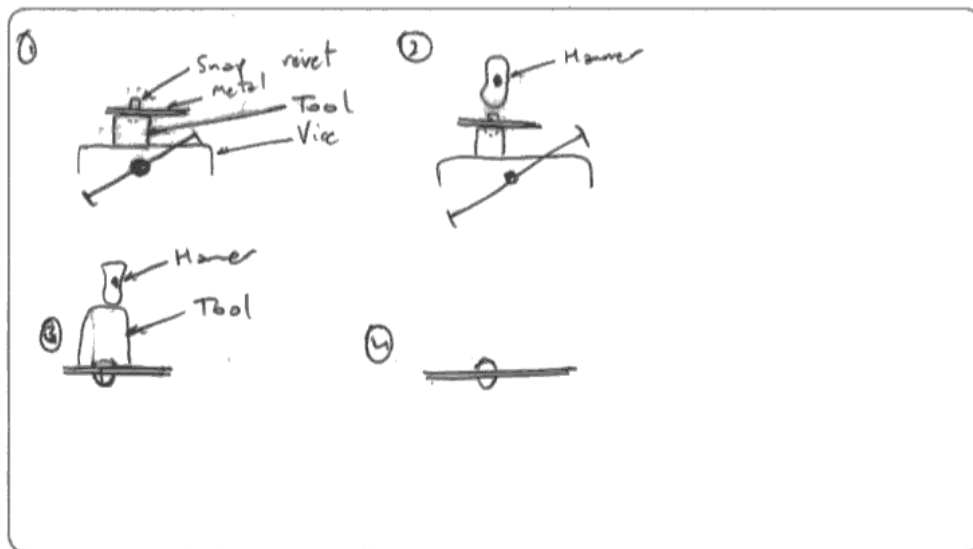

- ① A tool with a rounded indentation is placed in a vice and the rounded end of the snap rivet placed in it. The two bits of metal being joined are placed over it.
- ② Using ~~the~~ ~~hammer~~ there should be one and a half times the diameter left. Hit this with a hammer.
- ③ Take everything out of the vice and place the tool on the other end of the rivet and hit with a hammer to create a rounded end.
- ④ Finished joint.

The candidate clearly has reasonable knowledge of the process, but doesn't really use technical language to back up their answer.



ResultsPlus

Examiner Comments

The answer starts with 'a tool with a rounded indent is'. It is very important for candidates to use correct terminology.



ResultsPlus

Examiner Tip

Separate diagrams for each section of the process make this example easy to mark as each marking point is clearly shown.

Question 4 (b)

This question was designed to illicit answers which showed an understanding of the reasons why pop rivets are chosen as a suitable method for joining sheet metalwork together.

(b) Pop rivets could be used as an alternative to the snap (head) rivets.

Explain **two** reasons why pop rivets might be used in sheet metalwork.

(4)

- 1 Pop rivets are suitable when the user can only access one side of the materials being used making them more practical ^{in this circumstance} compared to snap rivets.
- 2 Pop rivets can be put in place using a pop rivet gun, this is more efficient ^{and faster} for large tasks compared to using snap rivets.

(Total for Question 4 = 8 marks)

The question expected justified answers to score full marks.



ResultsPlus

Examiner Comments

This candidate has made two valid points but has not justified them



ResultsPlus

Examiner Tip

Answer 1 would have been better if the candidate had explained that pop rivets can be fixed from one side only therefore making it suitable for use in 'blind' situations, e.g. where access to both sides is not possible or limited.

Answer 2 has a justification, ('for large tasks') but this is too vague. A better answer would have been pop rivets are quick to instal therefore reducing assembly time.

Question 5 (a)

This question allowed candidates to list two examples of a man-made board which could be used as an alternative to Chipboard for the table top.

This question was answered well by most candidates, but several candidates did use chipboard as an answer even though the question states two alternatives to chipboard.

Some candidates used solid timber, even though the question asks for manufactured boards.

Question 5 (b)

This question was concerned with the advantages man-made boards have over natural/solid timber for their application as a table top.

It is important for candidates to justify their answers in an 'explain' question. Many candidates gave three very good reasons but only scored half marks because they didn't justify their answers.

Question 5 (c)

This question allowed candidates to show their knowledge of how to overcome the disadvantage of the exposed edge which is present on man-made boards.

Some candidates only scored 1 mark as they only drew a piece of veneer for the edge of the chipboard but didn't mention how it would be attached.

(c) Sheets of veneered chipboard are often supplied with their edges left exposed.

Draw an annotated diagram of **one** suitable edge treatment a manufacturer could use to cover the exposed edges of the chipboard table top. (2)

(Total for Question 5 = 10 marks)

This question allowed the candidate to draw for a wide range of possible solutions to the stated problem of exposed edges on manufactured boards.

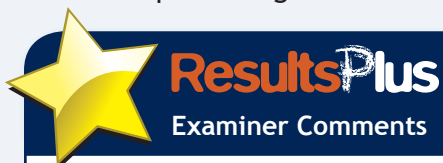

This candidate has used a clear diagram which helps to portray their knowledge and backs it up with clear annotation.

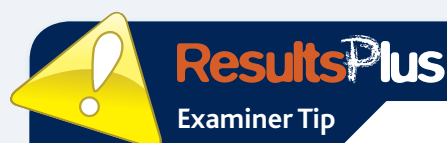

This candidate covered 'all bases' by giving a couple of alternative ways the laminate could have been attached to the chipboard.

Question 6 (a)

This question was concerned with the use of modelling as part of the design process. Candidates were expected to explain the inherent advantages of a block model and how it could be used prior to full scale manufacture.

*6 Figure 6 shows a wooden block model of a simple television remote control.



Figure 6

(a) Explain **two** reasons why it is important to produce a block model of the television remote control before going to the production stage.

(4)

2 The block model can be shown to important customers to check whether or not they are happy with the product.

This clip is used to show the flexibility of language that is accepted.



ResultsPlus

Examiner Comments

The candidate has scored 2 marks on this section of the answer.
 1 mark for 'showing the model to potential customers'
 1 mark for 'to gain feedback'
 The candidate has shown enough understanding that a customer would have to be satisfied with a product before committing to purchase and would have to feedback this information.



ResultsPlus

Examiner Tip

The use of technology related phrases like 'customer feedback' is encouraged.

Question 6 (b)

This question was concerned with the production of models using rapid prototyping. Candidates were expected to explain 3 advantages of producing a model using rapid prototyping.

It was very important for candidates to focus their answers on rapid prototyping and not just CAD.

(b) Explain **three** benefits of using rapid prototyping using CAD/CAM as an alternative method to block modelling.

(6)

2. It is a much quicker process so the product can potentially go into production quicker once the prototype has been looked at and accepted.

3. More detail can be inserted into the design using CAD/CAM so for meaning that the prototype looks more like the final product design.



ResultsPlus

Examiner Comments

Several candidates focussed their answers entirely on CAD and the ability to manipulate data electronically. This was not what the question focussed on.

This candidate scored full marks on answers 2 and 3 as they justified their reasons, but scored 0 for their first answer as it focussed on CAD and not rapid prototyping.

Question 7 (a)

This question was designed to illicit the basic outline of what Quality Assurance involves. Candidates were expected to make a valid point and justify/exemplify it.

*7 It is essential for businesses to have Quality Assurance (QA) systems in place.

(a) Explain what is meant by the term 'Quality Assurance' (2)

Quality assurance refers to the planned activities used by a manufacturer which monitor the quality of a product from its design and development, manufacture and end use. It also includes customer satisfaction.

Many candidates focussed entirely on Quality Control which is only a part of Quality Assurance.



ResultsPlus

Examiner Comments

Although this answer is not structured well, the candidate has made points about 'quality' and 'customer satisfaction', therefore scores 2 marks.



ResultsPlus

Examiner Tip

Candidates should be encouraged to think about the structure of their answers so that their justification flows from and relates to the point being made, rather than two separate sentences as shown here.

Question 7 (b)

This question was concerned with Total Quality Management (TQM) and how it impacts on company performance. Candidates were expected to give features of TQM and explain how they affect the way things are done and the impact they have on all aspects of a company.

On the whole, the answers to this question were not structured very well at all. Many answers had several points which scored marks, but they were scattered in a random manner.

The apparent lack of planning in many answers resulted in the same point being made several times, just using alternative wording. This means the candidate scores the mark just once, but uses a lot of time and space on the paper for relatively little credit.

The use of bullet pointed sentences/paragraphs is not penalised and can help many candidates organise their answers more coherently.

Overall, the trend is pleasing with many candidates showing an increased depth of subject knowledge and an ability to put this down in a coherent and succinct manner. However, it is very important to report that there are still far too many 'completely blank' answers to the more subject specific questions which suggest that not all centres are covering the whole specification in sufficient depth during their theory teaching.

Grade Boundaries

Grade	Max. Mark	A	B	C	D	E	N	U
Raw boundary mark	70	43	38	34	30	26	22	0
Uniform boundary mark	80	64	56	48	40	32	24	0

Further copies of this publication are available from
Edexcel Publications, Adamsway, Mansfield, Notts, NG18 4FN

Telephone 01623 467467

Fax 01623 450481

Email publications@linneydirect.com

Order Code US023749 June 2010

For more information on Edexcel qualifications, please visit
www.edexcel.com/quals

Edexcel Limited. Registered in England and Wales no.4496750
Registered Office: One90 High Holborn, London, WC1V 7BH

Ofqual



Llywodraeth Cynulliad Cymru
Welsh Assembly Government

