

Please check the examination details below before entering your candidate information

Candidate surname

Other names

Centre Number

Candidate Number

--	--	--	--	--

--	--	--	--

Pearson Edexcel International Advanced Level

Time 1 hour 45 minutes

Paper
reference

WPH14/01

Physics

International Advanced Level

UNIT 4: Further Mechanics, Fields and Particles

You must have:

Scientific calculator, ruler

Total Marks

Instructions

- Use **black** ink or ball-point pen.
- **Fill in the boxes** at the top of this page with your name, centre number and candidate number.
- Answer **all** questions.
- Answer the questions in the spaces provided
– *there may be more space than you need.*
- **Show all your working out** in calculations and **include units** where appropriate.

Information

- The total mark for this paper is 90.
- The marks for **each** question are shown in brackets
– *use this as a guide as to how much time to spend on each question.*
- In the question marked with an **asterisk** (*), marks will be awarded for your ability to structure your answer logically, showing how the points that you make are related or follow on from each other where appropriate.
- The list of data, formulae and relationships is printed at the end of this booklet.

Advice

- Read each question carefully before you start to answer it.
- Try to answer every question.
- Check your answers if you have time at the end.

Turn over ►

P69437A

©2022 Pearson Education Ltd.

L:1/1/1/1/



Pearson

SECTION A

Answer ALL questions.

For questions 1–10, in Section A, select one answer from A to D and put a cross in the box . If you change your mind, put a line through the box and then mark your new answer with a cross .

- 1 $^{17}_8\text{O}$ is an isotope of oxygen.

Which row of the table gives the number of nucleons and the number of neutrons in an atom of $^{17}_8\text{O}$?

	Number of nucleons	Number of neutrons
<input type="checkbox"/> A	8	8
<input type="checkbox"/> B	8	9
<input type="checkbox"/> C	17	8
<input type="checkbox"/> D	17	9

(Total for Question 1 = 1 mark)

- 2 Which row in the table gives the charge and mass of an antiproton?

	Charge/C	Mass/kg
<input type="checkbox"/> A	1.6×10^{-19}	-9.11×10^{-31}
<input type="checkbox"/> B	-1.6×10^{-19}	9.11×10^{-31}
<input type="checkbox"/> C	1.6×10^{-19}	-1.67×10^{-27}
<input type="checkbox"/> D	-1.6×10^{-19}	1.67×10^{-27}

(Total for Question 2 = 1 mark)



Questions 3 and 4 refer to a collision between two trolleys.

The diagram shows the momentum of two trolleys, X and Y, before a collision. The mass of each trolley is 0.25 kg.



The two trolleys join together after the collision and move on with a velocity of 1 m s^{-1} .

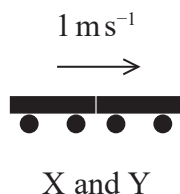

3 Which of the following is the kinetic energy of trolley X before the collision?

- A 0.5 J
- B 1 J
- C 2 J
- D 4 J

(Total for Question 3 = 1 mark)

4 Which row of the table is correct for this collision?

	Momentum	Elastic or inelastic collision
<input type="checkbox"/> A	conserved	elastic
<input type="checkbox"/> B	conserved	inelastic
<input type="checkbox"/> C	not conserved	elastic
<input type="checkbox"/> D	not conserved	inelastic

(Total for Question 4 = 1 mark)

DO NOT WRITE IN THIS AREA

DO NOT WRITE IN THIS AREA

DO NOT WRITE IN THIS AREA



P 6 9 4 3 7 A 0 3 2 8

Questions 5 and 6 refer to a cathode ray tube.

The diagram shows some of the components in a cathode ray tube.

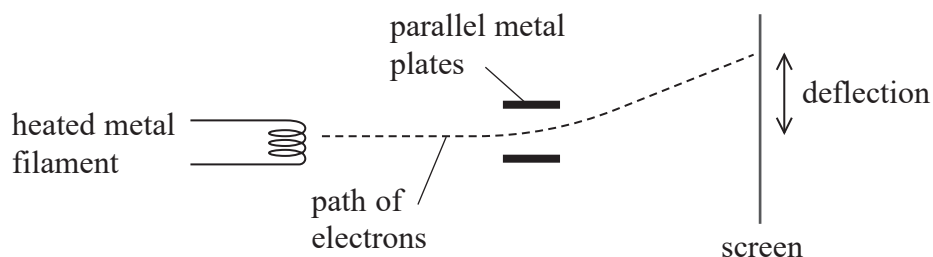

5 Electrons are released from the heated metal filament.

Which of the following is the name of this process?

- A ionisation
- B photoelectric emission
- C relativistic effect
- D thermionic emission

(Total for Question 5 = 1 mark)

6 When a potential difference is applied across the parallel metal plates, the electrons are deflected.

Which of the following changes would decrease the deflection of the electrons?

- A increasing the current in the metal filament
- B increasing the distance between the plates
- C increasing the length of the plates
- D increasing the potential difference across the plates

(Total for Question 6 = 1 mark)



- 7 A square coil PQRS has sides of length l . There is a clockwise current I in the coil as shown. The plane of the coil is parallel to a magnetic field of magnetic flux density B .

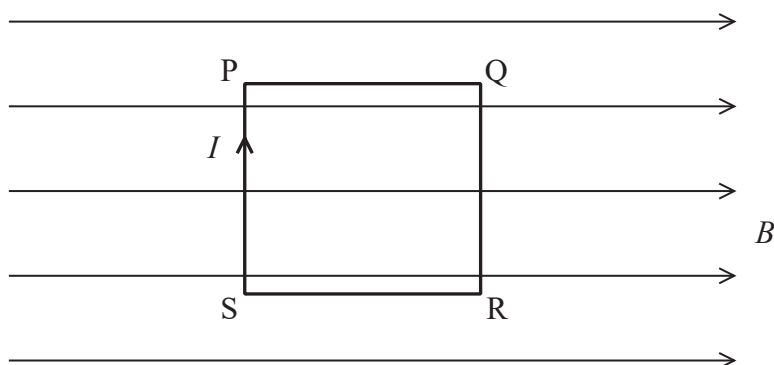

Which row of the table is correct?

	Side of coil	Magnetic force
<input type="checkbox"/> A	PQ	0
<input type="checkbox"/> B	QR	0
<input type="checkbox"/> C	RS	Bil into page
<input type="checkbox"/> D	SP	Bil out of page

(Total for Question 7 = 1 mark)

- 8 In the early 20th century experiments were carried out to measure the scattering of alpha particles after striking thin gold foil.

Which of the following could **not** be concluded from the results of these experiments?

- A The nucleus is charged.
- B The nucleus contains most of the mass of the atom.
- C The nucleus contains neutrons and protons.
- D The nucleus is very small compared to the atom.

(Total for Question 8 = 1 mark)



- 9 A charged particle is accelerated in a spiral path in a cyclotron.

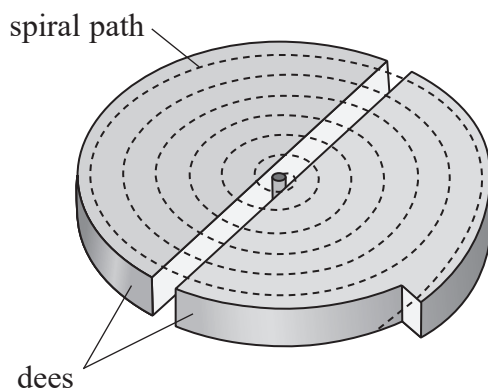

Which of the following changes would increase the amount of energy transferred to the particle as it travels through 360° ?

- A increasing the distance between the dees
- B increasing the frequency of the potential difference across the dees
- C increasing the strength of the magnetic field within the dees
- D increasing the maximum potential difference across the dees

(Total for Question 9 = 1 mark)

- 10 A website states: “The radius of the orbit of the Moon around the Earth is increasing by a small amount each year, however the time period of the orbit remains constant.”

Which row of the table is correct if the statement is true?

	Angular velocity of Moon	Speed of Moon
<input type="checkbox"/> A	constant	constant
<input type="checkbox"/> B	constant	increasing
<input type="checkbox"/> C	increasing	constant
<input type="checkbox"/> D	increasing	increasing

(Total for Question 10 = 1 mark)

TOTAL FOR SECTION A = 10 MARKS



SECTION B

Answer ALL questions. Write your answers in the spaces provided.

- 11** The diagram represents a negative point charge.

Draw field lines to show the electric field around the charge.



(Total for Question 11 = 3 marks)

DO NOT WRITE IN THIS AREA

DO NOT WRITE IN THIS AREA

DO NOT WRITE IN THIS AREA



12 A helicopter can hover in a fixed position as shown.

helicopter
blades



(Source: Ascent Xmedia/Getty Images)

The helicopter blades move air vertically downwards.

Explain how this enables the helicopter to maintain a constant height above the ground.

.....

.....

.....

.....

.....

.....

.....

.....

.....

.....

(Total for Question 12 = 4 marks)

DO NOT WRITE IN THIS AREA

DO NOT WRITE IN THIS AREA

DO NOT WRITE IN THIS AREA



DO NOT WRITE IN THIS AREA

DO NOT WRITE IN THIS AREA

DO NOT WRITE IN THIS AREA

BLANK PAGE



- 13 The surface of a balloon can become charged by rubbing it against clothing. The charge on the surface of the balloon can be assumed to act as if it was concentrated at the balloon's centre.

Two balloons are suspended by cotton threads so that they just touch each other as shown in diagram 1. The two balloons are then given an equal negative charge and repel as shown in diagram 2. The dots represent the centre of each balloon.

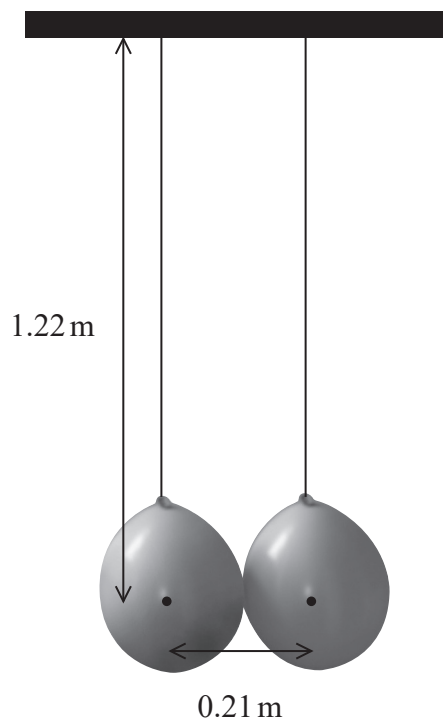

Diagram 1

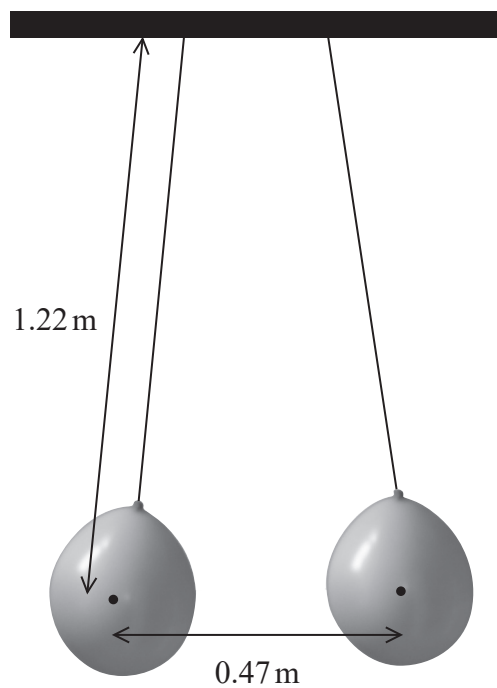

Diagram 2

- (a) (i) Show that the force of repulsion between the balloons in diagram 2 is about $1 \times 10^{-3} \text{ N}$.

mass of each balloon = 1.1 grams

(4)



(ii) Show that the charge on each balloon is about $2 \times 10^{-7} \text{C}$.

(2)

.....

.....

.....

.....

(b) One balloon is removed and the remaining balloon returns to its original position.

Calculate the electric potential at a distance of 0.30 m from the centre of the remaining balloon.

(2)

.....

.....

.....

.....

Electric potential =

(Total for Question 13 = 8 marks)

DO NOT WRITE IN THIS AREA

DO NOT WRITE IN THIS AREA

DO NOT WRITE IN THIS AREA



14 A student built the circuit shown. The capacitor was initially uncharged.

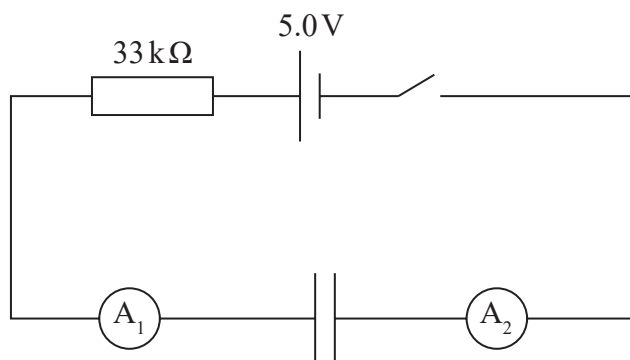

She closed the switch and plotted a graph of current on ammeter A_1 against time.

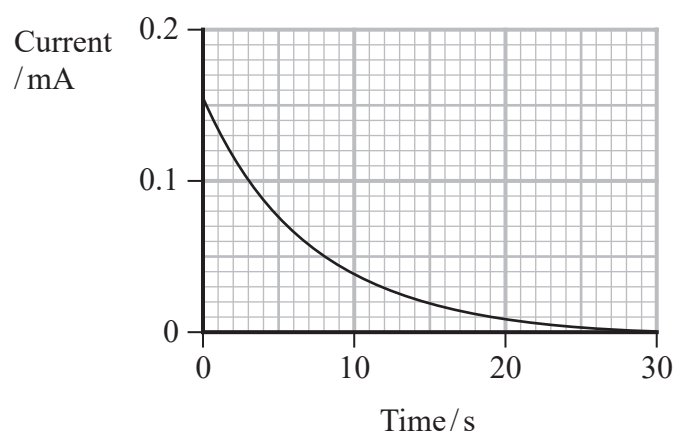

(a) Determine whether the initial value of current on the graph is consistent with the values stated on the circuit diagram.

(2)

.....

.....

.....

.....

(b) Explain how the current on ammeter A_2 would vary over the same time interval.

(2)

.....

.....

.....

.....



DO NOT WRITE IN THIS AREA

DO NOT WRITE IN THIS AREA

DO NOT WRITE IN THIS AREA

(c) Determine the capacitance of the capacitor.

(3)

Capacitance =

(d) Determine the charge stored on the capacitor after 30 s.

(2)

Charge stored on capacitor after 30 s =

(e) Determine the maximum energy stored by the capacitor.

(2)

Maximum energy =

(Total for Question 14 = 11 marks)



P 6 9 4 3 7 A 0 1 3 2 8

- 15 A poi ball is a ball attached to a person's hand by a cord. A child makes the poi ball undergo circular motion in a vertical plane as shown in the photograph.

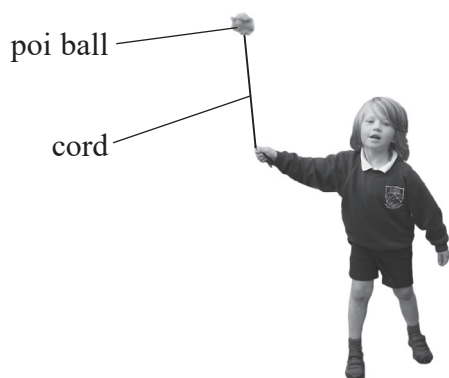

- (a) The poi ball moves clockwise in a circle of radius r , centre O , with a constant speed v .

The diagram shows two positions, A and B, of the poi ball.

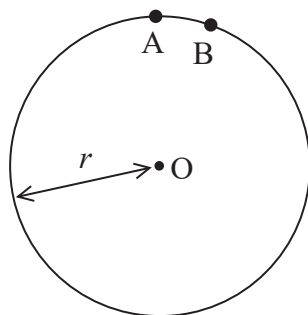

Derive the equation for centripetal acceleration $a = \frac{v^2}{r}$ by considering the velocity of the poi ball at these two positions.

Your answer should include a vector diagram.

(5)



(b) The poi ball completes 1.3 revolutions per second.

Calculate the acceleration of the poi ball.

radius of circular motion = 0.58 m

(3)

Acceleration =

(c) The child comments that as the ball goes round the circle with a constant speed, the size of the force on his hand changes.

Discuss whether this comment is correct.

(4)

(Total for Question 15 = 12 marks)



- 16 The diagram shows particle tracks in a detector. A negative K meson collided with a stationary proton. An omega baryon and a positive K meson were produced after the impact.

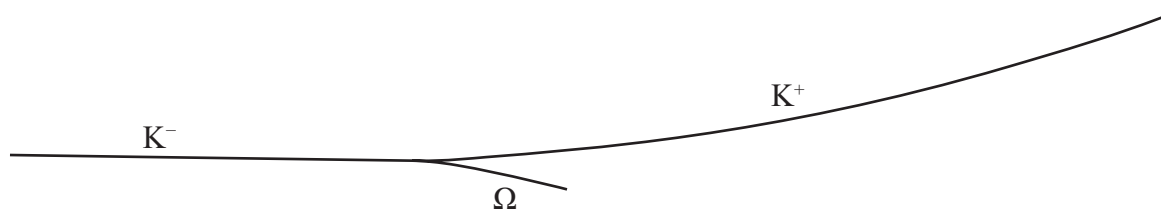

- (a) Explain the process that enables a particle detector to detect charged particles.

(2)

- (b) (i) Describe the structure of a baryon and a meson.

(2)

- (ii) A magnetic field acts in the detector.

State the direction of the magnetic field.

(1)



17 Experiments with muons are taking place at Fermilab in the USA to improve our understanding of the standard model.

(a) The muon belongs to the same family of particles as the electron.

State how the muon is classified in the standard model.

(2)

(b) A muon (μ) can be produced by the decay shown in this nuclear equation.

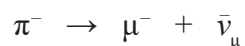

State the names of the two other particles involved.

(2)

(c) A website states: "The rest mass of a muon is $106 \text{ MeV}/c^2$, which is a little over 200 times that of an electron."

Deduce whether this statement is correct.

(3)



- (d) Muons are stored in a ‘storage ring’ at Fermilab. The website describes the ring as having a circumference of 44.7 m and using a magnetic field of flux density 1.45 T.

The website claims that this enables the storage ring to confine muons with a momentum of 3.10 GeV/c.

- (i) Explain why the unit GeV/c is a valid unit for momentum.

(2)

- (ii) Deduce whether the website’s claim is correct.

$$\text{muon charge} = -1.6 \times 10^{-19} \text{ C}$$

$$3.10 \text{ GeV/c} = 1.65 \times 10^{-18} \text{ N s}$$

(3)

- (iii) Stationary muons are unstable and have a mean lifetime of a few microseconds.

Explain why muons in the ring are observed to have a much greater mean lifetime.

(2)

(Total for Question 17 = 14 marks)



18 Faraday's law can be written as $\mathcal{E} = \frac{-d(N\phi)}{dt}$

(a) State the name of the term $N\phi$ and its unit.

(2)

(b) A coil of 500 turns and radius 3.0 mm is placed between two poles of an electromagnet as shown. The terminals are connected to an a.c. power supply.

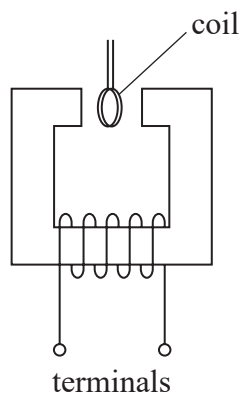

The magnetic flux density B perpendicular to the plane of the coil varies with time t as shown below.

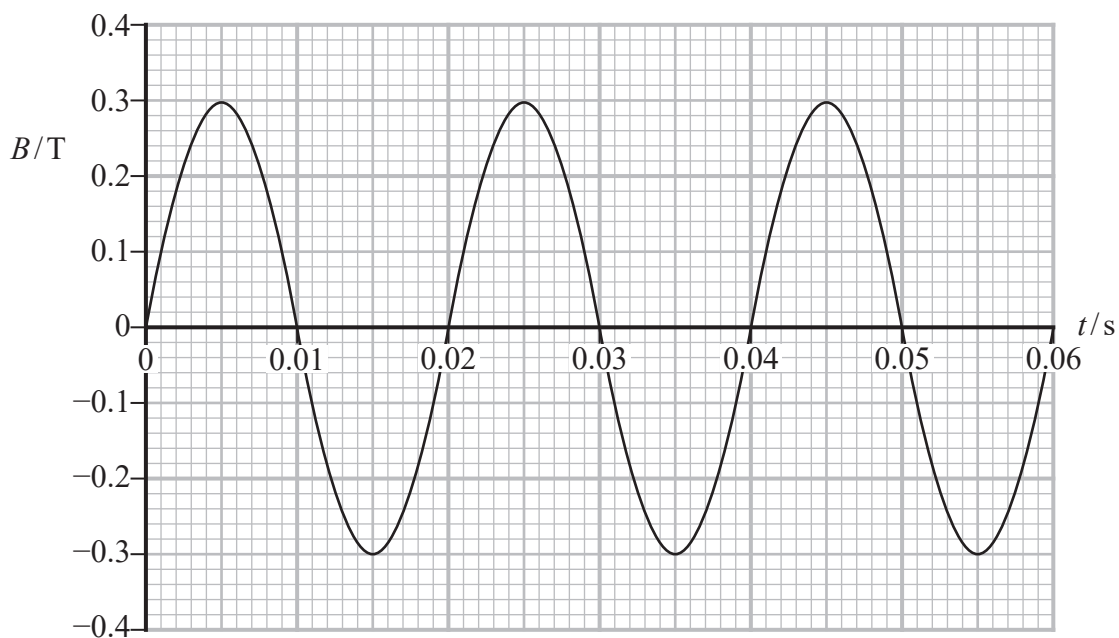

Determine the maximum e.m.f. across the coil.

(6)

DO NOT WRITE IN THIS AREA

DO NOT WRITE IN THIS AREA

DO NOT WRITE IN THIS AREA

.....

.....

.....

.....

.....

.....

.....

.....

.....

.....

.....

.....

Maximum e.m.f. =



List of data, formulae and relationships

Acceleration of free fall	$g = 9.81 \text{ m s}^{-2}$	(close to Earth's surface)
Boltzmann constant	$k = 1.38 \times 10^{-23} \text{ J K}^{-1}$	
Coulomb's law constant	$k = 1/4\pi\epsilon_0$ $= 8.99 \times 10^9 \text{ N m}^2 \text{ C}^{-2}$	
Electron charge	$e = -1.60 \times 10^{-19} \text{ C}$	
Electron mass	$m_e = 9.11 \times 10^{-31} \text{ kg}$	
Electronvolt	$1 \text{ eV} = 1.60 \times 10^{-19} \text{ J}$	
Gravitational constant	$G = 6.67 \times 10^{-11} \text{ N m}^2 \text{ kg}^{-2}$	
Gravitational field strength	$g = 9.81 \text{ N kg}^{-1}$	(close to Earth's surface)
Permittivity of free space	$\epsilon_0 = 8.85 \times 10^{-12} \text{ F m}^{-1}$	
Planck constant	$h = 6.63 \times 10^{-34} \text{ J s}$	
Proton mass	$m_p = 1.67 \times 10^{-27} \text{ kg}$	
Speed of light in a vacuum	$c = 3.00 \times 10^8 \text{ m s}^{-1}$	
Stefan-Boltzmann constant	$\sigma = 5.67 \times 10^{-8} \text{ W m}^{-2} \text{ K}^{-4}$	
Unified atomic mass unit	$u = 1.66 \times 10^{-27} \text{ kg}$	

Unit 1

Mechanics

Kinematic equations of motion	$s = \frac{(u + v)t}{2}$
	$v = u + at$
	$s = ut + \frac{1}{2}at^2$
	$v^2 = u^2 + 2as$

Forces	$\Sigma F = ma$
	$g = \frac{F}{m}$
	$W = mg$

Momentum	$p = mv$
----------	----------

Moment of force	moment = Fx
-----------------	---------------

Work and energy	$\Delta W = F\Delta s$
	$E_k = \frac{1}{2}mv^2$
	$\Delta E_{\text{grav}} = mg\Delta h$

Power	$P = \frac{E}{t}$
	$P = \frac{W}{t}$



Efficiency

$$\text{efficiency} = \frac{\text{useful energy output}}{\text{total energy input}}$$

$$\text{efficiency} = \frac{\text{useful power output}}{\text{total power input}}$$

Materials

Density

$$\rho = \frac{m}{V}$$

Stokes' law

$$F = 6\pi\eta rv$$

Hooke's law

$$\Delta F = k\Delta x$$

Elastic strain energy

$$\Delta E_{\text{el}} = \frac{1}{2}F\Delta x$$

Young modulus

$$E = \frac{\sigma}{\varepsilon} \text{ where}$$

$$\text{Stress } \sigma = \frac{F}{A}$$

$$\text{Strain } \varepsilon = \frac{\Delta x}{x}$$

DO NOT WRITE IN THIS AREA

DO NOT WRITE IN THIS AREA

DO NOT WRITE IN THIS AREA



Unit 2

Waves

Wave speed	$v = f\lambda$
Speed of a transverse wave on a string	$v = \sqrt{\frac{T}{\mu}}$
Intensity of radiation	$I = \frac{P}{A}$
Refractive index	$n_1 \sin \theta_1 = n_2 \sin \theta_2$ $n = \frac{c}{v}$
Critical angle	$\sin C = \frac{1}{n}$
Diffraction grating	$n\lambda = d \sin \theta$

Electricity

Potential difference	$V = \frac{W}{Q}$
Resistance	$R = \frac{V}{I}$
Electrical power, energy	$P = VI$ $P = I^2R$ $P = \frac{V^2}{R}$ $W = VIt$
Resistivity	$R = \frac{\rho l}{A}$
Current	$I = \frac{\Delta Q}{\Delta t}$ $I = nqvA$
Resistors in series	$R = R_1 + R_2 + R_3$
Resistors in parallel	$\frac{1}{R} = \frac{1}{R_1} + \frac{1}{R_2} + \frac{1}{R_3}$

Particle nature of light

Photon model	$E = hf$
Einstein's photoelectric equation	$hf = \phi + \frac{1}{2}mv_{\max}^2$
de Broglie wavelength	$\lambda = \frac{h}{p}$



Unit 4*Further mechanics*

Impulse

$$F\Delta t = \Delta p$$

Kinetic energy of a non-relativistic particle

$$E_k = \frac{p^2}{2m}$$

Motion in a circle

$$v = \omega r$$

$$T = \frac{2\pi}{\omega}$$

$$a = \frac{v^2}{r}$$

$$a = r\omega^2$$

Centripetal force

$$F = ma = \frac{mv^2}{r}$$

$$F = mr\omega^2$$

Electric and magnetic fields

Electric field

$$E = \frac{F}{Q}$$

Coulomb's law

$$F = \frac{Q_1 Q_2}{4\pi\epsilon_0 r^2}$$

$$E = \frac{Q}{4\pi\epsilon_0 r^2}$$

$$E = \frac{V}{d}$$

Electrical potential

$$V = \frac{Q}{4\pi\epsilon_0 r}$$

Capacitance

$$C = \frac{Q}{V}$$

Energy stored in capacitor

$$W = \frac{1}{2} QV$$

$$W = \frac{1}{2} CV^2$$

$$W = \frac{1}{2} \frac{Q^2}{C}$$

Capacitor discharge

$$Q = Q_0 e^{-t/RC}$$



Resistor-capacitor discharge

$$I = I_0 e^{-t/RC}$$

$$V = V_0 e^{-t/RC}$$

$$\ln Q = \ln Q_0 - \frac{t}{RC}$$

$$\ln I = \ln I_0 - \frac{t}{RC}$$

$$\ln V = \ln V_0 - \frac{t}{RC}$$

In a magnetic field

$$F = Bqv \sin \theta$$

$$F = BIl \sin \theta$$

Faraday's and Lenz's laws

$$\mathcal{E} = \frac{-d(N\phi)}{dt}$$

Nuclear and particle physics

In a magnetic field

$$r = \frac{p}{BQ}$$

Mass-energy

$$\Delta E = c^2 \Delta m$$

DO NOT WRITE IN THIS AREA

DO NOT WRITE IN THIS AREA

DO NOT WRITE IN THIS AREA



P 6 9 4 3 7 A 0 2 7 2 8

DO NOT WRITE IN THIS AREA

DO NOT WRITE IN THIS AREA

DO NOT WRITE IN THIS AREA

BLANK PAGE

