



UNIVERSITY OF CAMBRIDGE INTERNATIONAL EXAMINATIONS  
General Certificate of Education  
Advanced Subsidiary Level and Advanced Level

**PHYSICS**

**9702/12**

Paper 1 Multiple Choice

**October/November 2012**

**1 hour**

Additional Materials: Multiple Choice Answer Sheet  
Soft clean eraser  
Soft pencil (type B or HB is recommended)

\* 5 5 8 3 7 7 6 3 7 3 \*

**READ THESE INSTRUCTIONS FIRST**

Write in soft pencil.  
Do not use staples, paper clips, highlighters, glue or correction fluid.  
Write your name, Centre number and candidate number on the Answer Sheet in the spaces provided unless this has been done for you.

There are **forty** questions on this paper. Answer **all** questions. For each question there are four possible answers **A, B, C** and **D**.  
Choose the **one** you consider correct and record your choice in **soft pencil** on the separate Answer Sheet.

**Read the instructions on the Answer Sheet very carefully.**

Each correct answer will score one mark. A mark will not be deducted for a wrong answer.  
Any working should be done in this booklet.

This document consists of **25** printed pages and **3** blank pages.



**Data**

speed of light in free space,	$c = 3.00 \times 10^8 \text{ m s}^{-1}$
permeability of free space,	$\mu_0 = 4\pi \times 10^{-7} \text{ H m}^{-1}$
permittivity of free space,	$\epsilon_0 = 8.85 \times 10^{-12} \text{ F m}^{-1}$ $(\frac{1}{4\pi\epsilon_0} = 8.99 \times 10^9 \text{ m F}^{-1})$
elementary charge,	$e = 1.60 \times 10^{-19} \text{ C}$
the Planck constant,	$h = 6.63 \times 10^{-34} \text{ J s}$
unified atomic mass constant,	$u = 1.66 \times 10^{-27} \text{ kg}$
rest mass of electron,	$m_e = 9.11 \times 10^{-31} \text{ kg}$
rest mass of proton,	$m_p = 1.67 \times 10^{-27} \text{ kg}$
molar gas constant,	$R = 8.31 \text{ J K}^{-1} \text{ mol}^{-1}$
the Avogadro constant,	$N_A = 6.02 \times 10^{23} \text{ mol}^{-1}$
the Boltzmann constant,	$k = 1.38 \times 10^{-23} \text{ J K}^{-1}$
gravitational constant,	$G = 6.67 \times 10^{-11} \text{ N m}^2 \text{ kg}^{-2}$
acceleration of free fall,	$g = 9.81 \text{ m s}^{-2}$

**Formulae**

uniformly accelerated motion,	$s = ut + \frac{1}{2}at^2$ $v^2 = u^2 + 2as$
work done on/by a gas,	$W = p\Delta V$
gravitational potential,	$\phi = -\frac{Gm}{r}$
hydrostatic pressure,	$p = \rho gh$
pressure of an ideal gas,	$p = \frac{1}{3}\frac{Nm}{V}\langle c^2 \rangle$
simple harmonic motion,	$a = -\omega^2 x$
velocity of particle in s.h.m.,	$v = v_0 \cos \omega t$ $v = \pm \omega \sqrt{x_0^2 - x^2}$
electric potential,	$V = \frac{Q}{4\pi\epsilon_0 r}$
capacitors in series,	$1/C = 1/C_1 + 1/C_2 + \dots$
capacitors in parallel,	$C = C_1 + C_2 + \dots$
energy of charged capacitor,	$W = \frac{1}{2}QV$
resistors in series,	$R = R_1 + R_2 + \dots$
resistors in parallel,	$1/R = 1/R_1 + 1/R_2 + \dots$
alternating current/voltage,	$x = x_0 \sin \omega t$
radioactive decay,	$x = x_0 \exp(-\lambda t)$
decay constant,	$\lambda = \frac{0.693}{t_{\frac{1}{2}}}$

1 Which quantity has the same base units as momentum?

- A density  $\times$  energy
- B density  $\times$  volume  $\times$  velocity
- C pressure  $\times$  area
- D weight  $\div$  area

2 Vectors P and Q are drawn to scale.



Which diagram represents the vector  $(P + Q)$ ?

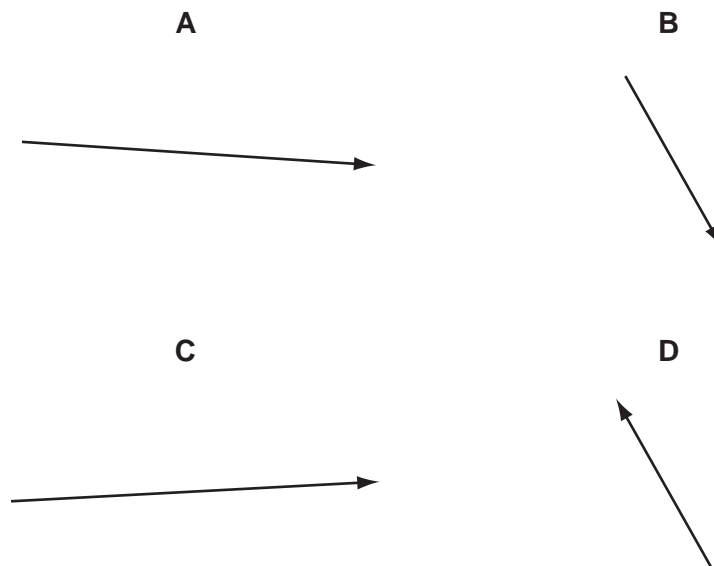

Space for working

3 What is the approximate kinetic energy of an Olympic athlete when running at maximum speed during a 100 m race?

- A 400 J                      B 4000 J                      C 40 000 J                      D 400 000 J

4 Physical quantities can be classed as vectors or as scalars.

Which pair of quantities are both vectors?

- A kinetic energy and elastic force  
B momentum and time  
C velocity and electric field strength  
D weight and temperature

5 A student is given a reel of wire of diameter less than 0.2 mm and is asked to find the density of the metal.

Which pair of instruments would be most suitable for finding the **volume** of the wire?

- A balance and micrometer  
B metre rule and micrometer  
C metre rule and vernier calipers  
D micrometer and vernier calipers

**Space for working**

- 6 Variables  $x$  and  $y$  are related by the equation  $y = p - qx$  where  $p$  and  $q$  are constants. Values of  $x$  and  $y$  are measured experimentally. The results contain a systematic error. Which graph best represents these results?

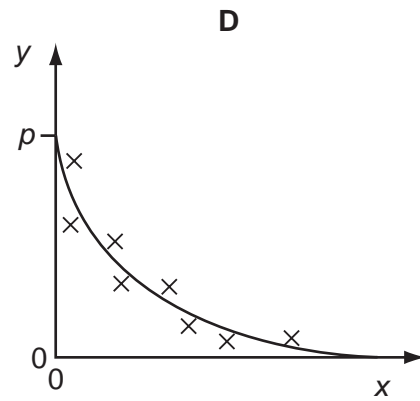
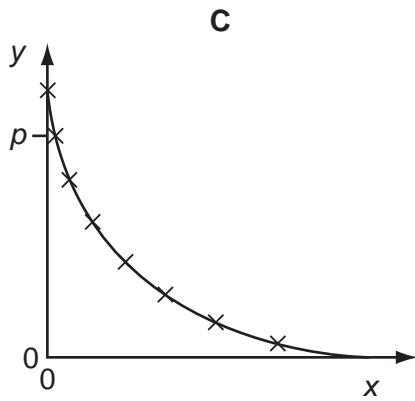
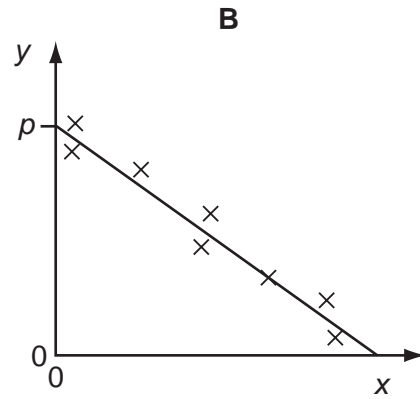
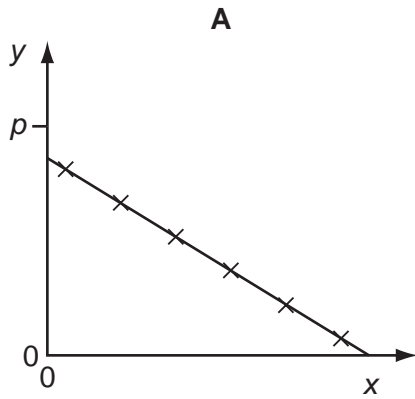

Space for working

- 7 The speed of a car is calculated from measurements of the distance travelled and the time taken.

The distance is measured as 200 m, with an uncertainty of  $\pm 2$  m.

The time is measured as 10.0 s, with an uncertainty of  $\pm 0.2$  s.

What is the percentage uncertainty in the calculated speed?

- A**  $\pm 0.5\%$       **B**  $\pm 1\%$       **C**  $\pm 2\%$       **D**  $\pm 3\%$

- 8 A science museum designs an experiment to show the fall of a feather in a vertical glass vacuum tube.

The time of fall from rest is to be close to 0.5 s.

What length of tube is required?

- A** 1.3 m      **B** 2.5 m      **C** 5.0 m      **D** 10.0 m

**Space for working**

- 9 The graph of velocity against time for an object moving in a straight line is shown.

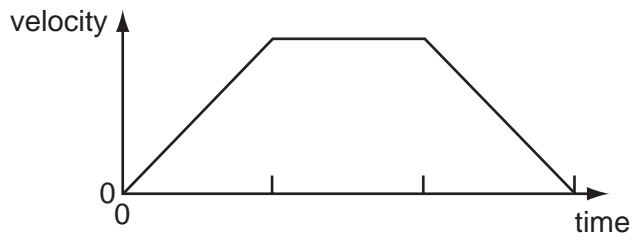

What is the corresponding graph of displacement against time?

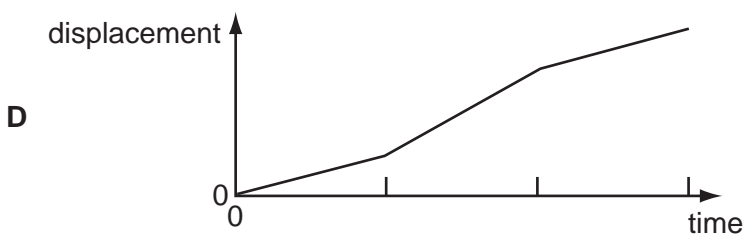
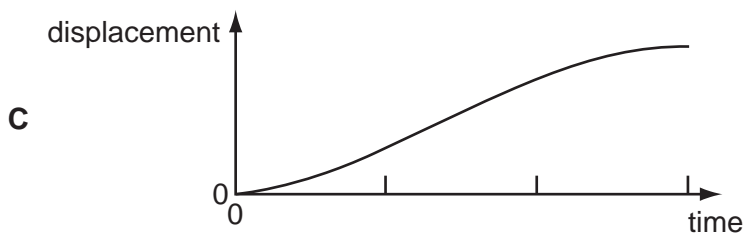
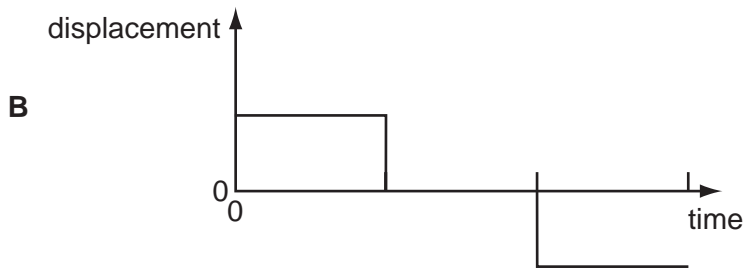
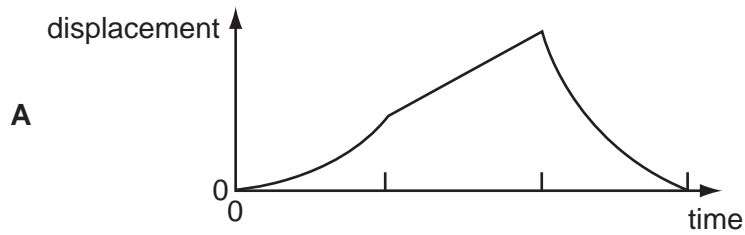

Space for working



10 The dotted line shows the path of a competitor in a ski-jumping competition.

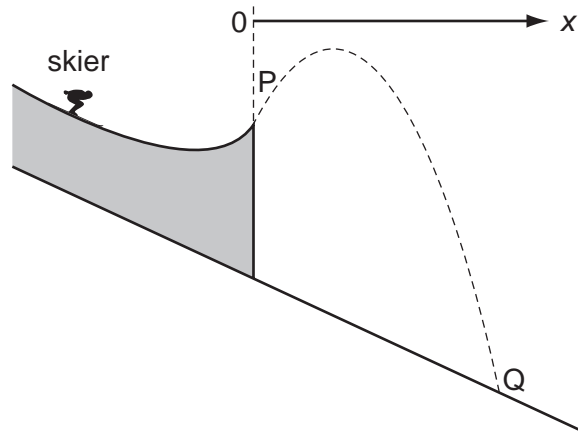

Ignoring air resistance, which graph best represents the variation of his speed  $v$  with the horizontal distance  $x$  covered from the start of his jump at P before landing at Q?

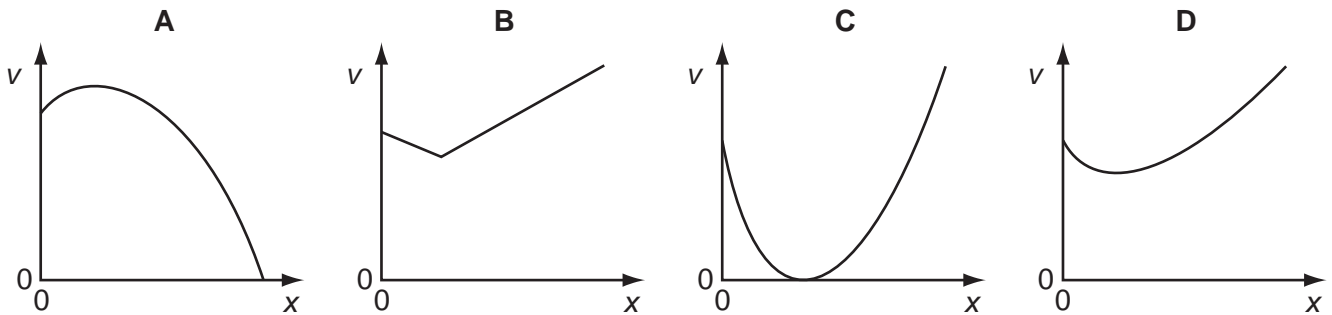

Space for working

11 The velocity of a car changes as shown.

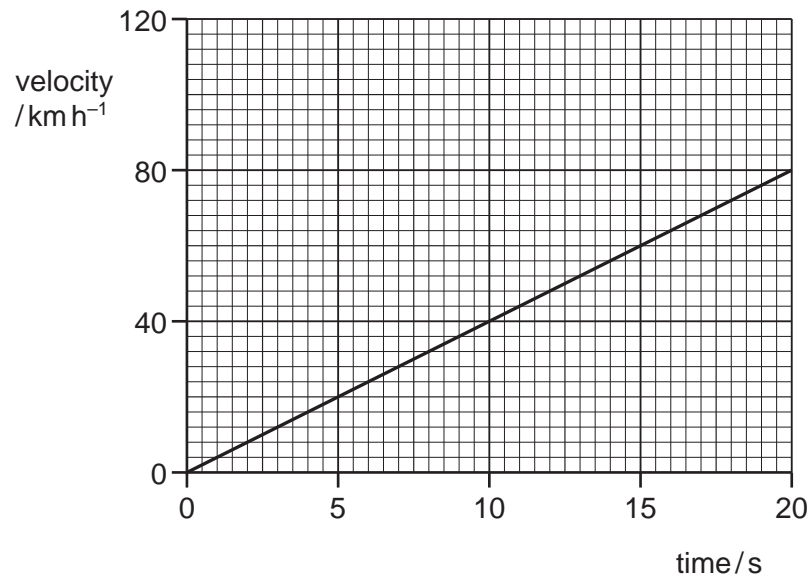

What is the acceleration of the car?

- A**  $1.1 \text{ ms}^{-2}$       **B**  $4.0 \text{ ms}^{-2}$       **C**  $224 \text{ ms}^{-2}$       **D**  $800 \text{ ms}^{-2}$

12 A ball of mass  $0.5 \text{ kg}$  is thrown against a wall at a speed of  $12 \text{ ms}^{-1}$ . It bounces back with a speed of  $8 \text{ ms}^{-1}$ . The collision lasts for  $0.10 \text{ s}$ .

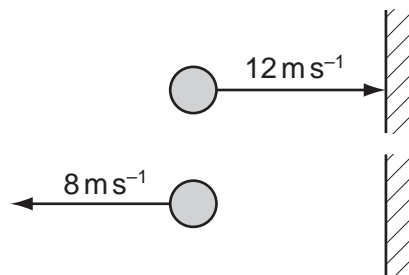

What is the average force on the ball due to the collision?

- A**  $0.2 \text{ N}$       **B**  $1 \text{ N}$       **C**  $20 \text{ N}$       **D**  $100 \text{ N}$

**Space for working**

- 13 Two identical, perfectly elastic spheres have the same mass  $m$ . They travel towards each other with the same speed  $v$  along a horizontal frictionless surface.

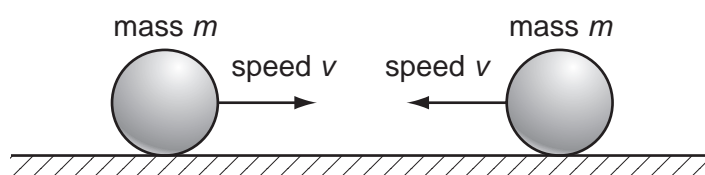

Which statement about the sum of the kinetic energies of the spheres is correct?

- A The sum of their kinetic energies before impact is zero.  
 B The sum of their kinetic energies before impact is  $\frac{1}{2}mv^2$ .  
 C The sum of their kinetic energies after impact is zero.  
 D The sum of their kinetic energies after impact is  $mv^2$ .
- 14 A 1.2 kg mass is supported by a person's hand and two newton-meters as shown.

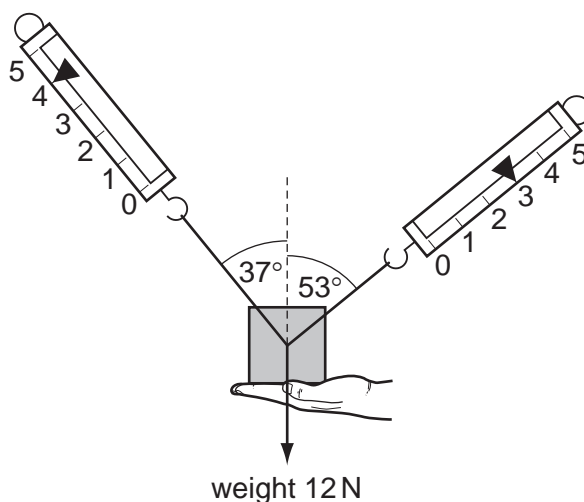

When the person's hand is removed, what is the initial vertical acceleration of the mass?

- A  $0.6 \text{ ms}^{-2}$       B  $2 \text{ ms}^{-2}$       C  $4 \text{ ms}^{-2}$       D  $6 \text{ ms}^{-2}$

Space for working

15 A lorry of mass 20 000 kg has a constant resultant force  $F$  acting on it.

It accelerates from  $6.0 \text{ m s}^{-1}$  to  $30.0 \text{ m s}^{-1}$  in a time of 300 s.

What is the change in momentum of the lorry and the value of  $F$ ?

	change in momentum / N s	force $F$ / N
<b>A</b>	48 000	160
<b>B</b>	480 000	1600
<b>C</b>	600 000	2000
<b>D</b>	600 000	20 000

16 A stationary body floats in water.

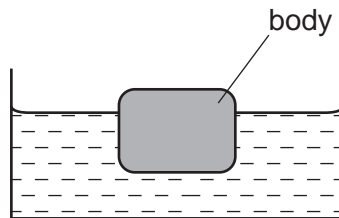

Which statement about the forces acting on the body is correct?

- A** The gravitational force is equal to the viscous force.
- B** The gravitational force is greater than the upthrust.
- C** The upthrust is zero.
- D** The viscous force is zero.

**Space for working**

17 A rigid uniform beam is pivoted horizontally at its midpoint.

Different vertical forces are applied to different positions on the beam.

In which diagram is the beam in equilibrium?

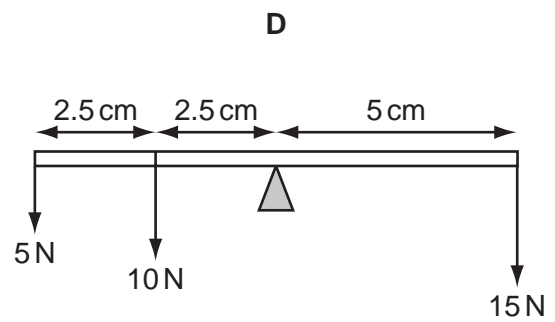
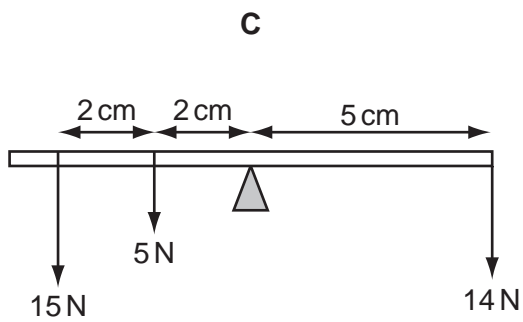
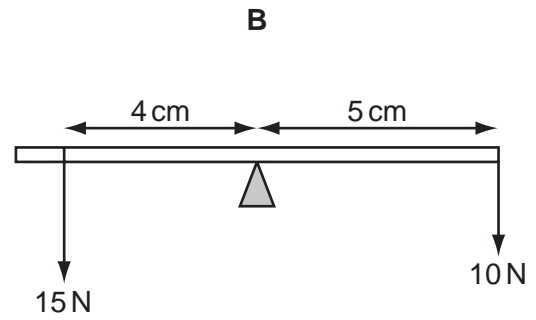
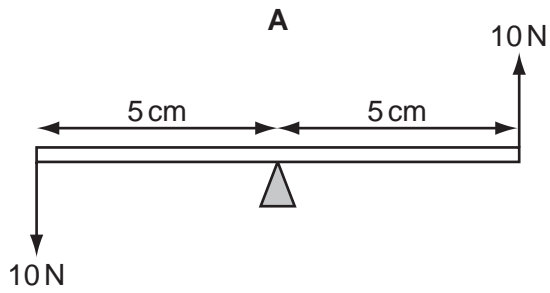

Space for working

- 18 A picture on a wall is supported by a wire looped over a nail.

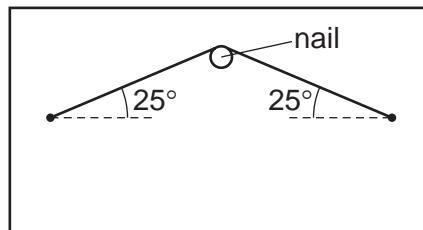

The mass of the picture is 4.2 kg.

What is the tension in the supporting wire?

- A** 5.0 N      **B** 23 N      **C** 49 N      **D** 97 N
- 19 A piston in a gas supply pump has an area of  $500 \text{ cm}^2$  and it moves a distance of 30 cm during one stroke.
- The pump moves the gas against a fixed pressure of 4000 Pa.
- How much work is done by the piston during one stroke?
- A** 60 J      **B**  $6.0 \times 10^3 \text{ J}$       **C**  $6.0 \times 10^5 \text{ J}$       **D**  $6.0 \times 10^7 \text{ J}$
- 20 A railway engine accelerates a train of total mass 1200 tonnes (1 tonne = 1000 kg) from rest to a speed of  $75 \text{ m s}^{-1}$ .

How much useful work must be done on the train to reach this speed?

- A**  $1.7 \times 10^6 \text{ J}$       **B**  $3.4 \times 10^6 \text{ J}$       **C**  $1.7 \times 10^9 \text{ J}$       **D**  $3.4 \times 10^9 \text{ J}$

**Space for working**

- 21 A crane is being used to lift containers off a ship. One container has a mass of 14 000 kg and is being lifted vertically with a speed of  $3.2 \text{ m s}^{-1}$ .

The electric motor being used to supply the power to lift the container is using a current of 240 A at a potential difference of 2200 V.

What is the efficiency of the system?

- A 8.1%                      B 8.5%                      C 48%                      D 83%

- 22 Trains supply coal to a power station. The table below gives quantities describing the operation of the power station.

	symbol	unit
power station output	$P$	W
number of trains per day	$N$	
mass of coal on a train	$M$	kg
energy from 1 kg of coal	$J$	J
number of seconds in one day	$S$	

Which expression gives the efficiency of the power station?

- A  $\frac{PS}{NMJ}$                       B  $\frac{PSN}{MJ}$                       C  $\frac{NMJ}{PS}$                       D  $\frac{NM}{PSJ}$

**Space for working**

- 23 Which row correctly describes the spacing and motion of the molecules in water and in ice when both are at a temperature of 0 °C?

	spacing	motion
<b>A</b>	molecules in ice are further apart than molecules in water	molecules in both ice and water have the same average speed
<b>B</b>	molecules in ice are further apart than molecules in water	molecules in ice travel more slowly than those in water
<b>C</b>	molecules in ice are closer than molecules in water	molecules in ice travel more slowly than those in water
<b>D</b>	molecules in ice are closer than molecules in water	molecules in both ice and water have the same average speed

- 24 Which row gives the correct description for the arrangement of atoms in the four types of material?

	atoms have no long-range order	atoms form giant chain-like molecules	atoms have an ordered arrangement in regions, but these ordered regions are at angles to one another	atoms are arranged in an ordered way throughout
<b>A</b>	crystalline	amorphous	polymeric	polycrystalline
<b>B</b>	polycrystalline	crystalline	amorphous	polymeric
<b>C</b>	polymeric	polycrystalline	crystalline	amorphous
<b>D</b>	amorphous	polymeric	polycrystalline	crystalline

Space for working



25 What leads to the conclusion that the movement of molecules is random?

- A evaporation of water at room temperature
- B conduction of electricity in water
- C convection currents in air
- D motion of dust particles in air

26 The diagram shows the force-extension graphs for two materials, of the same dimensions, loaded to fracture.

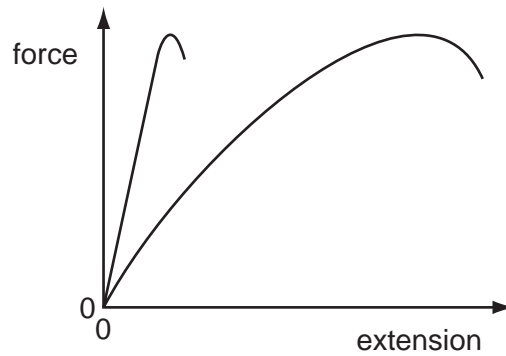

What describes the behaviour of the materials?

- A Both materials are brittle.
- B Both materials obey Hooke's law.
- C Both materials are plastic.
- D Both materials have the same ultimate tensile stress.

**Space for working**

- 27 Two wires, X and Y, are made from different metals and have different dimensions. The Young modulus of wire X is twice that of wire Y. The diameter of wire X is half that of wire Y.

Both wires are extended with equal strain and obey Hooke's law.

What is the ratio  $\frac{\text{tension in wire X}}{\text{tension in wire Y}}$  ?

- A  $\frac{1}{8}$                       B  $\frac{1}{2}$                       C 1                      D 8

- 28 The diagram shows two identical loudspeakers driven in phase by a common audio-frequency source.

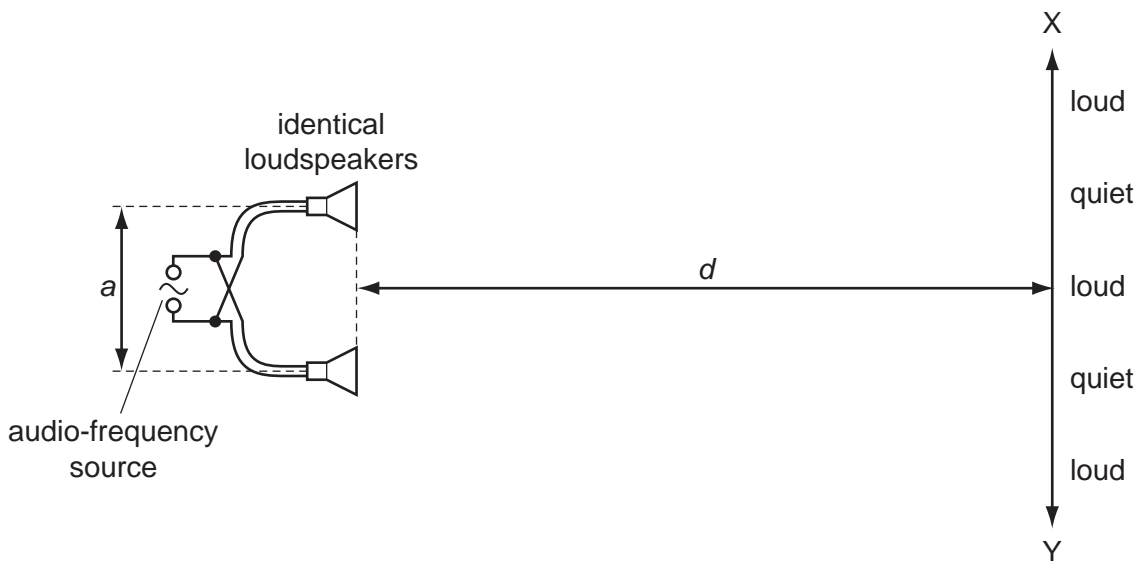

When a student moves along line  $XY$ , she notices that there are variations in the loudness of the sound. The regions in which the sound is heard are alternately loud and quiet as indicated on the diagram.

How may the distance between loud regions be reduced?

- A decreasing the distance  $a$  between the speakers  
 B increasing distance  $d$   
 C increasing the frequency of the audio-frequency source  
 D increasing the power output from the audio-frequency source

**Space for working**

- 29 A horizontal glass tube, closed at one end, has a layer of dust laid inside it on its lower side. Sound is emitted from a loudspeaker that is placed near the open end of the tube.

The frequency of the sound is varied and, at one frequency, a stationary wave is formed inside the tube so that the dust forms small heaps.

The distance between four heaps of dust is 30 cm.

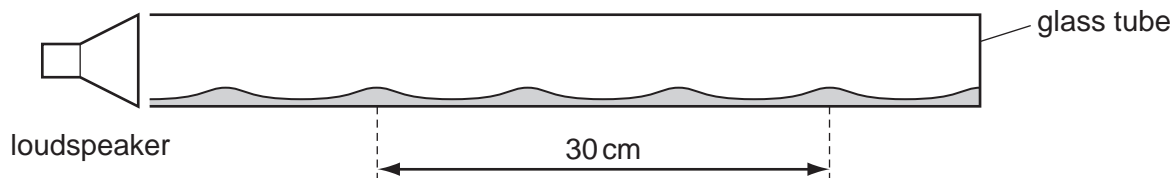

The speed of sound in the tube is  $330 \text{ m s}^{-1}$ .

What is the frequency of the sound emitted by the loudspeaker?

- A 1650 Hz      B 2200 Hz      C 3300 Hz      D 6600 Hz
- 30 Monochromatic light of wavelength 690 nm passes through a diffraction grating with 300 lines per mm, producing a series of maxima on a screen.

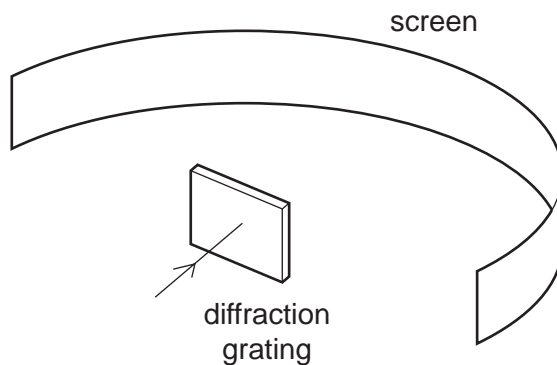

What is the greatest number of maxima that can be observed?

- A 4      B 5      C 8      D 9

**Space for working**

31 The diagram shows a cathode-ray oscilloscope display of an electromagnetic wave.

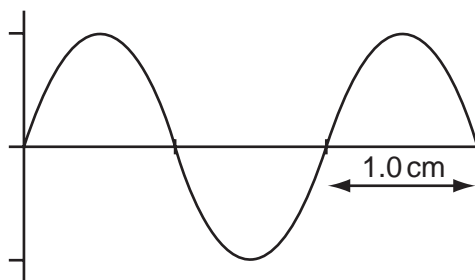

The time base setting is  $0.20 \mu\text{s cm}^{-1}$ .

Which statement is correct?

- A The frequency of the wave is 2.5 MHz and it lies in the radio wave region of the electromagnetic spectrum.
  - B The frequency of the wave is 2.5 MHz and it lies in the microwave region of the electromagnetic spectrum.
  - C The frequency of the wave is 5.0 MHz and it lies in the radio wave region of the electromagnetic spectrum.
  - D The frequency of the wave is 5.0 MHz and it lies in the microwave region of the electromagnetic spectrum.
- 32 A charged particle moves in a uniform electric field between two parallel metal plates.

To calculate the force acting on the particle due to the electric field, which quantity is **not** required?

- A particle charge
- B particle speed
- C plate separation
- D potential difference between the plates

**Space for working**

- 33 A single proton travelling with a constant horizontal velocity enters a uniform electric field between two parallel charged plates. In the diagram, **B** shows the path taken by the proton.

Which path is taken by a helium nucleus that enters the electric field at the same point and with the same velocity as the proton?

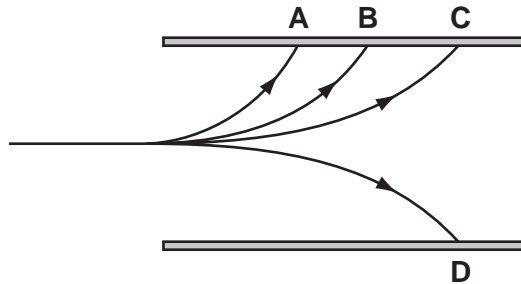

- 34 The graph shows the variation with length  $l$  of resistance  $R$  for two wires X and Y made from the same material.

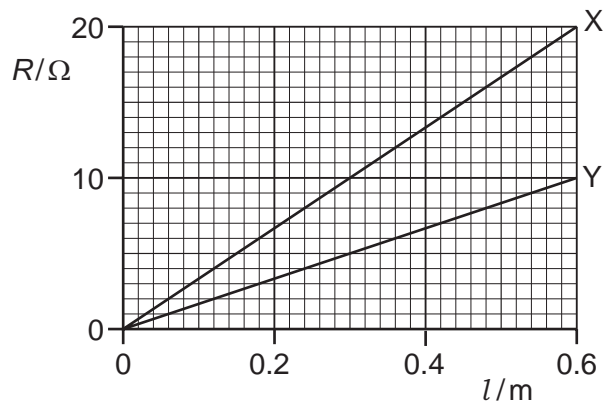

What does the graph show?

- A** cross-sectional area of X =  $2 \times$  cross-sectional area of Y
- B** resistivity of X =  $2 \times$  resistivity of Y
- C** when equal lengths of X and Y are connected in series to a battery, power in X =  $2 \times$  power in Y
- D** when equal lengths of X and Y are connected in parallel to a battery, current in X =  $2 \times$  current in Y

**Space for working**

- 35 A cell of internal resistance  $2.0\ \Omega$  and electromotive force (e.m.f.)  $1.5\ \text{V}$  is connected to a resistor of resistance  $3.0\ \Omega$ .

What is the potential difference across the  $3.0\ \Omega$  resistor?

- A  $1.5\ \text{V}$       B  $1.2\ \text{V}$       C  $0.9\ \text{V}$       D  $0.6\ \text{V}$

- 36 A  $100\ \Omega$  resistor conducts a current with changing direction and magnitude, as shown.

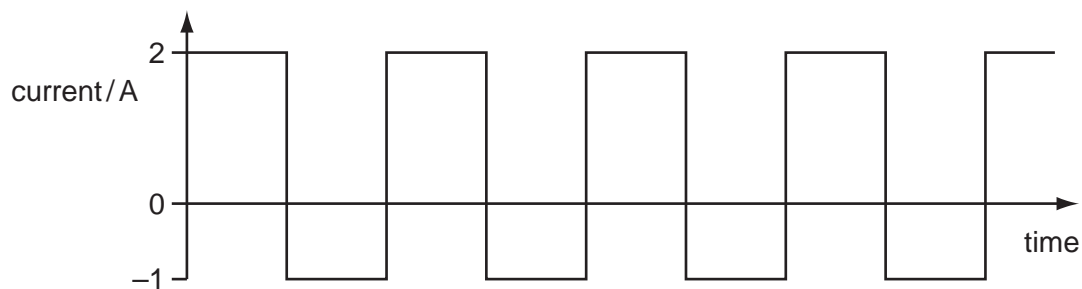

What is the mean power dissipated in the resistor?

- A  $100\ \text{W}$       B  $150\ \text{W}$       C  $250\ \text{W}$       D  $400\ \text{W}$

**Space for working**

37 The ammeter reading in the circuit below is  $I$ .

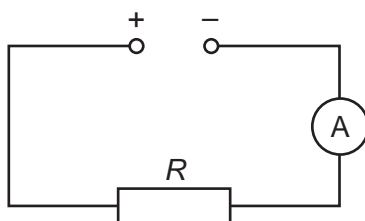

Another circuit containing the same voltage supply, two switches, an ammeter and two resistors each of resistance  $R$ , is shown.

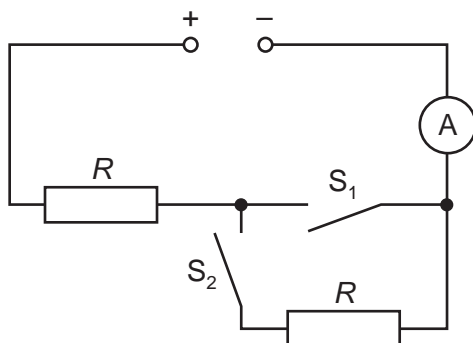

Which row is **not** correct?

	$S_1$	$S_2$	ammeter reading
<b>A</b>	closed	closed	$I$
<b>B</b>	closed	open	$I$
<b>C</b>	open	closed	$I$
<b>D</b>	open	open	0

Space for working

- 38 A light-dependent resistor  $R$  has resistance of about  $1\text{ M}\Omega$  in the dark and about  $1\text{ k}\Omega$  when illuminated. It is connected in series with a  $5\text{ k}\Omega$  resistor to a  $1.5\text{ V}$  cell of negligible internal resistance.

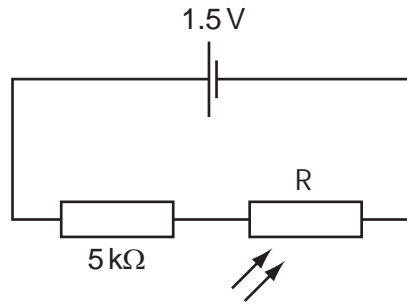

The light-dependent resistor is illuminated (in an otherwise dark room) by a flashing light.

Which graph best shows the variation with time  $t$  of potential difference  $V$  across  $R$ ?

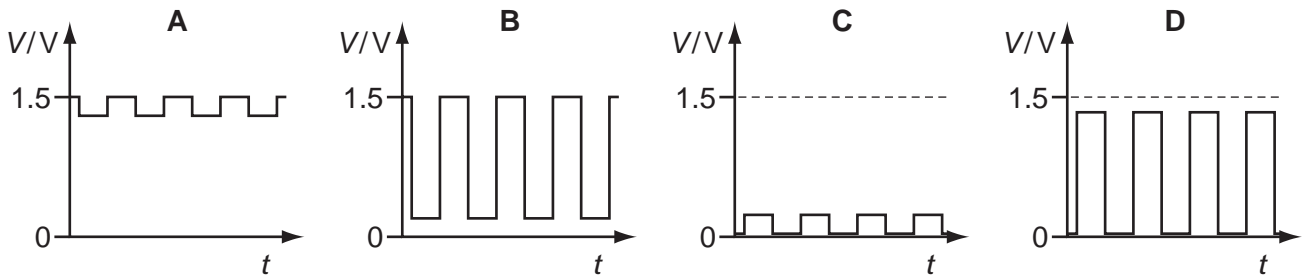

Space for working



- 39 A material contains a radioactive isotope that disintegrates solely by the emission of  $\alpha$ -particles at a rate of  $100\text{ s}^{-1}$ .

Which statement about this material is correct?

- A The number of atoms in the material diminishes at a rate of  $100\text{ s}^{-1}$ .
  - B The number of neutrons in the material diminishes at a rate of  $100\text{ s}^{-1}$ .
  - C The number of nucleons in the material diminishes at a rate of  $400\text{ s}^{-1}$ .
  - D The number of protons in the material diminishes at a rate of  $100\text{ s}^{-1}$ .
- 40 A different nucleus can be formed by bombarding a stable nucleus with an energetic  $\alpha$ -particle.

${}_{11}^{23}\text{Na}$  is bombarded with an energetic  $\alpha$ -particle.

What could be the products of this nuclear reaction?

- A  ${}_{10}^{25}\text{Ne}$  + neutron
- B  ${}_{11}^{25}\text{Na}$  + proton
- C  ${}_{12}^{26}\text{Mg}$  +  $\beta$
- D  ${}_{13}^{27}\text{Al}$  +  $\gamma$

**Space for working**





**BLANK PAGE**

---

Permission to reproduce items where third-party owned material protected by copyright is included has been sought and cleared where possible. Every reasonable effort has been made by the publisher (UCLES) to trace copyright holders, but if any items requiring clearance have unwittingly been included, the publisher will be pleased to make amends at the earliest possible opportunity.

University of Cambridge International Examinations is part of the Cambridge Assessment Group. Cambridge Assessment is the brand name of University of Cambridge Local Examinations Syndicate (UCLES), which is itself a department of the University of Cambridge.