

**PHYSICS**

**9702/12**

Paper 1 Multiple Choice

**October/November 2014**

**1 hour**

Additional Materials: Multiple Choice Answer Sheet  
Soft clean eraser  
Soft pencil (type B or HB is recommended)

**READ THESE INSTRUCTIONS FIRST**

Write in soft pencil.

Do not use staples, paper clips, glue or correction fluid.

Write your name, Centre number and candidate number on the Answer Sheet in the spaces provided unless this has been done for you.

**DO NOT WRITE IN ANY BARCODES.**

There are **forty** questions on this paper. Answer **all** questions. For each question there are four possible answers **A, B, C** and **D**.

Choose the **one** you consider correct and record your choice in **soft pencil** on the separate Answer Sheet.

**Read the instructions on the Answer Sheet very carefully.**

Each correct answer will score one mark. A mark will not be deducted for a wrong answer.

Any working should be done in this booklet.

Electronic calculators may be used.

This document consists of **26** printed pages and **2** blank pages.



**Data**

speed of light in free space,	$c = 3.00 \times 10^8 \text{ m s}^{-1}$
permeability of free space,	$\mu_0 = 4\pi \times 10^{-7} \text{ H m}^{-1}$
permittivity of free space,	$\epsilon_0 = 8.85 \times 10^{-12} \text{ F m}^{-1}$ $(\frac{1}{4\pi\epsilon_0} = 8.99 \times 10^9 \text{ m F}^{-1})$
elementary charge,	$e = 1.60 \times 10^{-19} \text{ C}$
the Planck constant,	$h = 6.63 \times 10^{-34} \text{ J s}$
unified atomic mass constant,	$u = 1.66 \times 10^{-27} \text{ kg}$
rest mass of electron,	$m_e = 9.11 \times 10^{-31} \text{ kg}$
rest mass of proton,	$m_p = 1.67 \times 10^{-27} \text{ kg}$
molar gas constant,	$R = 8.31 \text{ J K}^{-1} \text{ mol}^{-1}$
the Avogadro constant,	$N_A = 6.02 \times 10^{23} \text{ mol}^{-1}$
the Boltzmann constant,	$k = 1.38 \times 10^{-23} \text{ J K}^{-1}$
gravitational constant,	$G = 6.67 \times 10^{-11} \text{ N m}^2 \text{ kg}^{-2}$
acceleration of free fall,	$g = 9.81 \text{ m s}^{-2}$

**Formulae**

uniformly accelerated motion,

$$s = ut + \frac{1}{2}at^2$$

$$v^2 = u^2 + 2as$$

work done on/by a gas,

$$W = p\Delta V$$

gravitational potential,

$$\phi = -\frac{Gm}{r}$$

hydrostatic pressure,

$$p = \rho gh$$

pressure of an ideal gas,

$$p = \frac{1}{3} \frac{Nm}{V} \langle c^2 \rangle$$

simple harmonic motion,

$$a = -\omega^2 x$$

velocity of particle in s.h.m.,

$$v = v_0 \cos \omega t$$

$$v = \pm \omega \sqrt{(x_0^2 - x^2)}$$

electric potential,

$$V = \frac{Q}{4\pi\epsilon_0 r}$$

capacitors in series,

$$1/C = 1/C_1 + 1/C_2 + \dots$$

capacitors in parallel,

$$C = C_1 + C_2 + \dots$$

energy of charged capacitor,

$$W = \frac{1}{2}QV$$

resistors in series,

$$R = R_1 + R_2 + \dots$$

resistors in parallel,

$$1/R = 1/R_1 + 1/R_2 + \dots$$

alternating current/voltage,

$$x = x_0 \sin \omega t$$

radioactive decay,

$$x = x_0 \exp(-\lambda t)$$

decay constant,

$$\lambda = \frac{0.693}{t_{\frac{1}{2}}}$$

- 1 A 0.10 kg mass is taken to Mars and then weighed on a spring balance and on a lever balance. The acceleration due to gravity on Mars is 38% of its value on Earth.

What are the readings on the two balances on Mars? (Assume that on Earth  $g = 10 \text{ m s}^{-2}$ .)

	spring balance / N	lever balance / kg
<b>A</b>	0.38	0.038
<b>B</b>	0.38	0.10
<b>C</b>	1.0	0.038
<b>D</b>	1.0	0.10

- 2 What is equivalent to the unit of electric field strength?

**A**  $\text{J C m}^{-1}$       **B**  $\text{N s A}^{-1}$       **C**  $\text{kg m s}^{-3} \text{ A}^{-1}$       **D**  $\text{kg m}^3 \text{ s}^{-3} \text{ A}^{-1}$

- 3 The diagram shows the reading on an analogue ammeter.

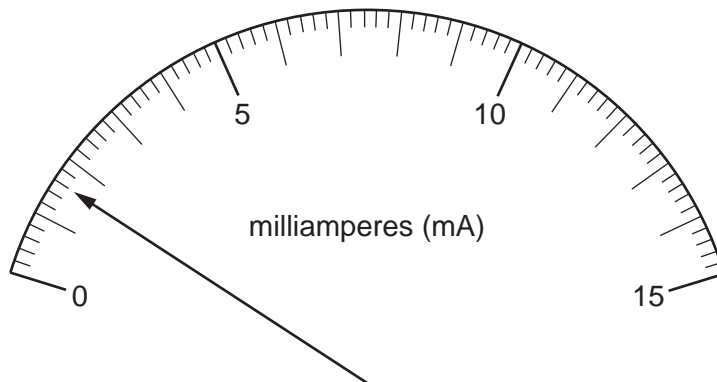

Which digital ammeter reading is the same as the reading on the analogue ammeter?

	display units	display reading
<b>A</b>	$\mu\text{A}$	1600
<b>B</b>	$\mu\text{A}$	160
<b>C</b>	mA	16.0
<b>D</b>	A	1.60

**Space for working**

- 4 A steel wire is stretched in an experiment to determine the Young modulus for steel.

The uncertainties in the measurements are given below.

measurement	uncertainty
load on wire	$\pm 2\%$
length of wire	$\pm 0.2\%$
diameter of wire	$\pm 1.5\%$
extension	$\pm 1\%$

What is the percentage uncertainty in the Young modulus?

- A 1.3%                      B 1.8%                      C 4.7%                      D 6.2%
- 5 The acceleration of free fall on the Moon is one-sixth of that on Earth.

On Earth it takes time  $t$  for a stone to fall from rest a distance of 2 m.

What is the time taken for a stone to fall from rest a distance of 2 m on the Moon?

- A  $6t$                       B  $\frac{t}{6}$                       C  $t\sqrt{6}$                       D  $\frac{t}{\sqrt{6}}$

**Space for working**

- 6 Which graph represents the motion of a car that is travelling along a straight road with a speed that increases uniformly with time?

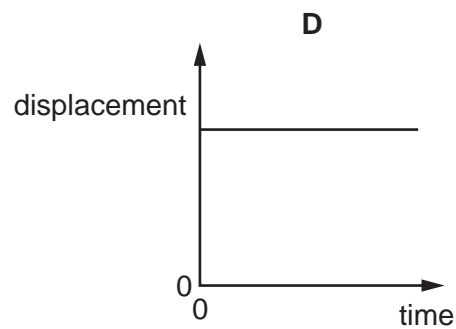
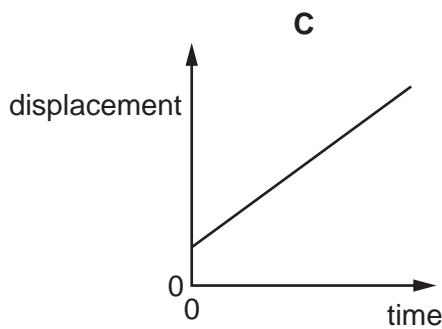
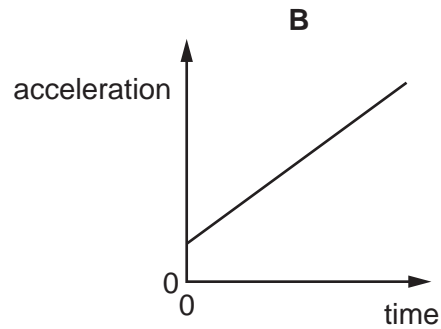
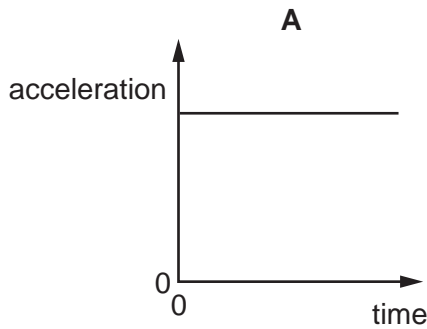

- 7 What is the principle of conservation of momentum?
- A** Force is equal to the rate of change of momentum.
- B** Momentum is the product of mass and velocity.
- C** The total momentum of a system remains constant provided no external force acts on it.
- D** The total momentum of two bodies after collision is equal to their total momentum before collision.
- 8 Water is pumped through a hose-pipe at a rate of 90 kg per minute. It emerges from the hose-pipe horizontally with a speed of  $20 \text{ m s}^{-1}$ .

Which force is required from a person holding the hose-pipe to prevent it moving backwards?

- A** 30 N                      **B** 270 N                      **C** 1800 N                      **D** 10 800 N

**Space for working**

- 9 Two railway trucks of masses  $m$  and  $3m$  move towards each other in opposite directions with speeds  $2v$  and  $v$  respectively. These trucks collide and stick together.

What is the speed of the trucks after the collision?

- A  $\frac{v}{4}$                       B  $\frac{v}{2}$                       C  $v$                       D  $\frac{5v}{4}$

- 10 A glider is descending at constant speed at an angle of  $15^\circ$  to the horizontal. The diagram shows the directions of the lift  $L$ , air resistance  $R$  and weight  $W$  acting on the glider.

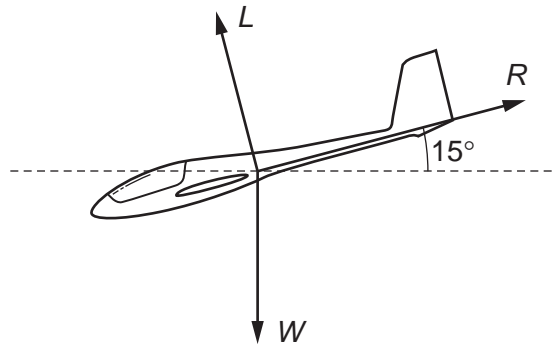

Which vector triangle could represent the forces acting on the glider?

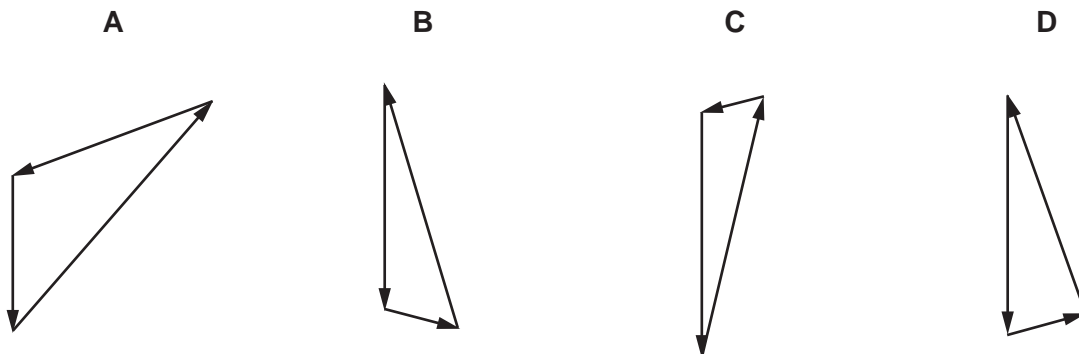

Space for working

- 11 A ball is falling at terminal speed in still air. The forces acting on the ball are upthrust, viscous drag and weight.

What is the order of increasing magnitude of these three forces?

- A upthrust → viscous drag → weight
- B viscous drag → upthrust → weight
- C viscous drag → weight → upthrust
- D weight → upthrust → viscous drag

**Space for working**



- 12 A uniform ladder rests against a vertical wall where there is negligible friction. The bottom of the ladder rests on rough ground where there is friction. The top of the ladder is at a height  $h$  above the ground and the foot of the ladder is at a distance  $2a$  from the wall.

The diagram shows the forces that act on the ladder.

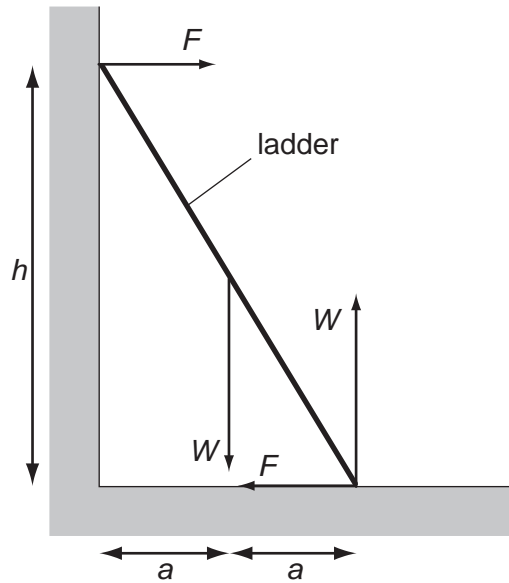

Which equation is formed by taking moments?

- A  $Wa + Fh = 2Wa$
- B  $Fa + Wa = Fh$
- C  $Wa + 2Wa = Fh$
- D  $Wa - 2Wa = 2Fh$

Space for working

- 13 A mass attached to the lower end of a spring bounces up and down.

At which points in the path of the mass do the gravitational potential energy of the mass (GPE), the elastic potential energy in the spring (EPE) and the kinetic energy of the mass (KE) have their highest values?

	GPE	EPE	KE
<b>A</b>	bottom	middle	top
<b>B</b>	bottom	top	middle
<b>C</b>	top	bottom	middle
<b>D</b>	top	bottom	top

- 14 A mass  $m$  is situated in a uniform gravitational field.

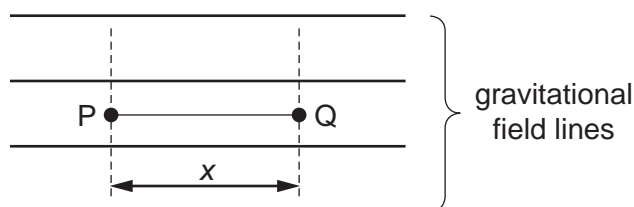

When the mass moves through a displacement  $x$ , from P to Q, it loses an amount of potential energy  $E$ .

Which row correctly specifies the magnitude and the direction of the acceleration due to gravity in this field?

	magnitude	direction
<b>A</b>	$\frac{E}{mx}$	→
<b>B</b>	$\frac{E}{mx}$	←
<b>C</b>	$\frac{E}{x}$	→
<b>D</b>	$\frac{E}{x}$	←

Space for working

- 15 A small electric motor is mounted on a bench, as shown. The motor is connected to a 6.0V supply and the current in the motor is 0.50 A. The motor is 50% efficient.

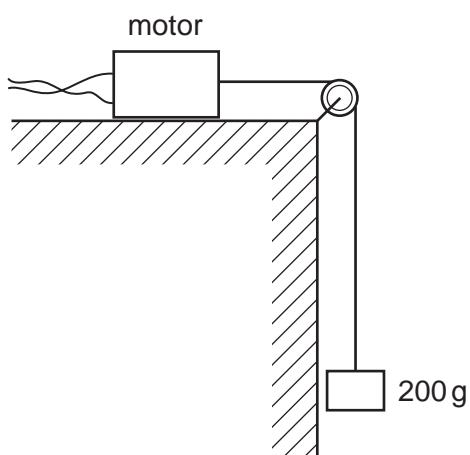

What is the time taken to lift a mass of 200 g up through a height of 90 cm?

- A** 0.59 s      **B** 0.85 s      **C** 1.2 s      **D** 2.7 s
- 16 A projectile is launched at  $45^\circ$  to the horizontal with initial kinetic energy  $E$ .
- Assuming air resistance to be negligible, what will be the kinetic energy of the projectile when it reaches its highest point?
- A**  $0.50E$       **B**  $0.71E$       **C**  $0.87E$       **D**  $E$
- 17 What is the correct name for a material containing long-chain molecules that are tangled and coiled?
- A** amorphous metal  
**B** amorphous polymer  
**C** crystalline metal  
**D** crystalline polymer

**Space for working**

18 Which statement about molecules in a gas is correct?

- A In Brownian motion experiments, the molecules can be seen moving randomly in all directions.
- B The pressure exerted by a gas is caused by molecules bouncing against each other and changing kinetic energy.
- C The pressure exerted by a gas is caused by molecules rebounding from the walls of a container and changing momentum.
- D When the average speed of the molecules in a closed container increases, the density must also increase.

19 The diagram shows the atoms of a substance with the atoms at the corners of a cube. The average separation of the atoms at a particular temperature is 15 nm.

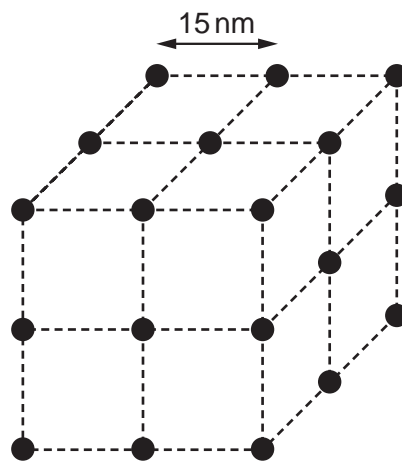

When the temperature changes so that the average separation becomes 17 nm, by which factor will the density of the substance change?

- A 0.61
- B 0.69
- C 0.78
- D 0.88

Space for working

20 The stress-strain graph for a glass rod, up to the point at which it breaks, is shown below.

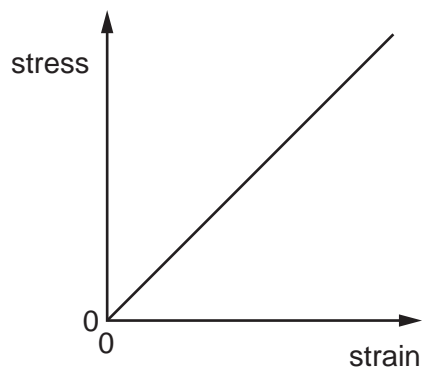

Which statement about the glass rod is correct?

- A Hooke's law is obeyed for all values of stress up to the breaking point.
  - B The glass is ductile.
  - C The glass shows plastic deformation.
  - D When the cross-sectional area of the rod is doubled, the ultimate tensile stress of the rod is halved.
- 21 A rubber band is stretched by hanging weights on it and the force-extension graph is plotted from the results.

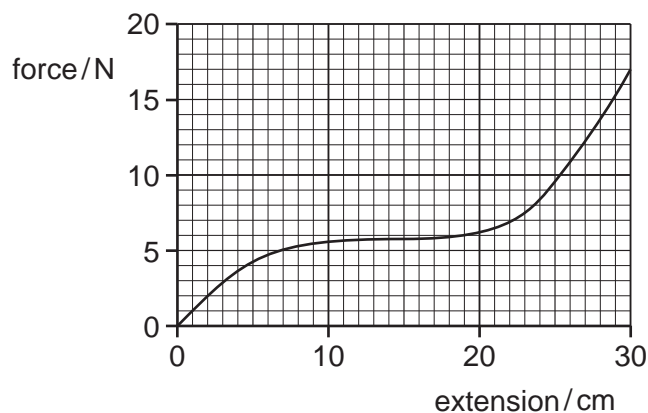

What is the best estimate of the strain energy stored in the rubber band when it is extended 30 cm?

- A 1.8 J
- B 2.6 J
- C 5.1 J
- D 200 J

Space for working

22 Which statement about electromagnetic radiation is correct?

- A Waves of wavelength  $5 \times 10^{-9}$  m are high-energy gamma rays.
- B Waves of wavelength  $3 \times 10^{-8}$  m are ultra-violet waves.
- C Waves of wavelength  $5 \times 10^{-7}$  m are infra-red waves.
- D Waves of wavelength  $9 \times 10^{-7}$  m are light waves.

23 When sound travels through air, the air particles vibrate. A graph of displacement against time for a single air particle is shown.

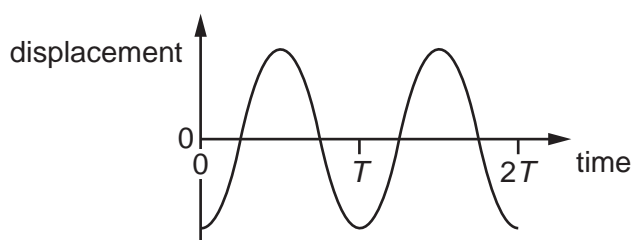

Which graph best shows how the kinetic energy of the air particle varies with time?

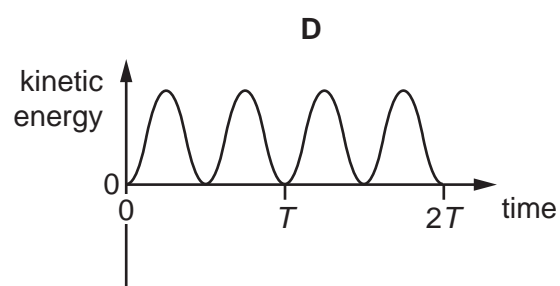
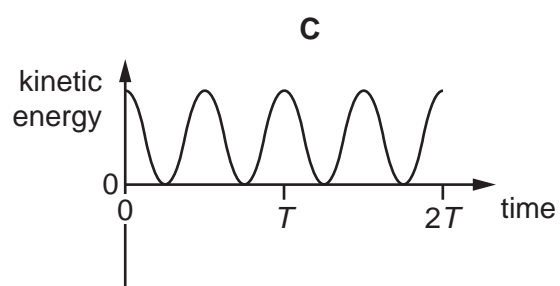
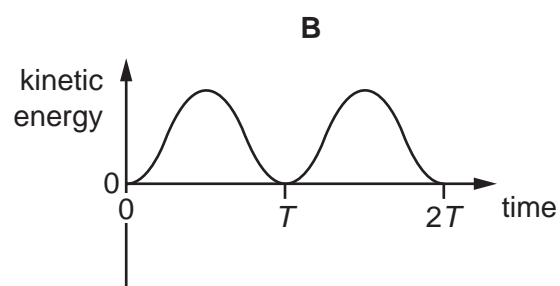
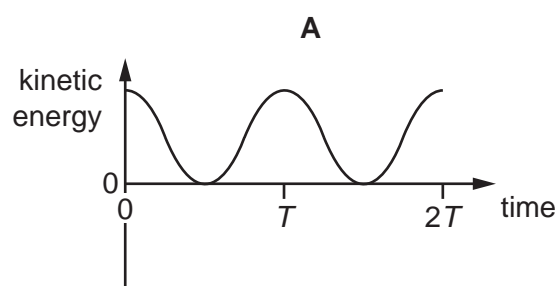

Space for working

24 Which statement describes a situation when polarisation could **not** occur?

- A Light waves are reflected.
- B Light waves are scattered.
- C Microwaves pass through a metal grid.
- D Sound waves pass through a metal grid.

25 A stationary sound wave is produced in a tube.

Which statement describes the wave speed?

- A It is the distance between two adjacent nodes divided by the period of the wave.
- B It is the speed at which energy is transferred from one antinode to an adjacent antinode.
- C It is the speed of a particle at an antinode.
- D It is the speed of one of the progressive waves that are producing the stationary wave.

**Space for working**

26 Two identical loudspeakers are connected in series to an a.c. supply, as shown.

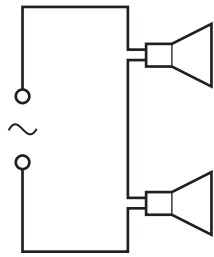

Which graph best shows the variation of the intensity of the sound with distance along the line XY?

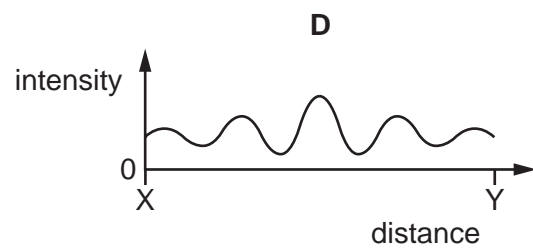
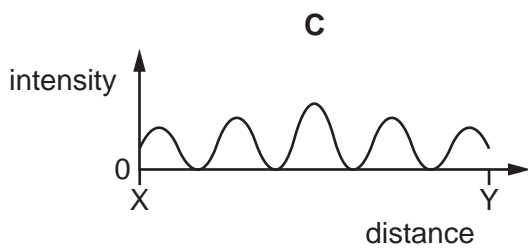
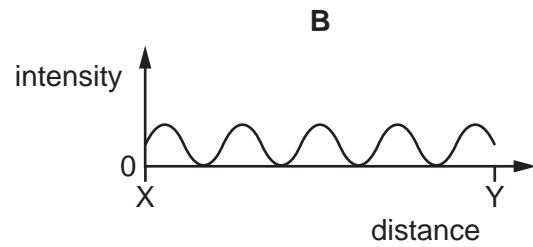
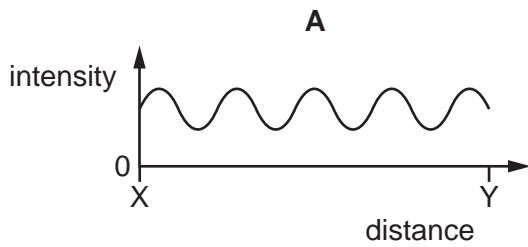

**Space for working**



- 27 A diffraction grating experiment is set up using yellow light of wavelength 600 nm. The grating has a slit separation of  $2.00\ \mu\text{m}$ .

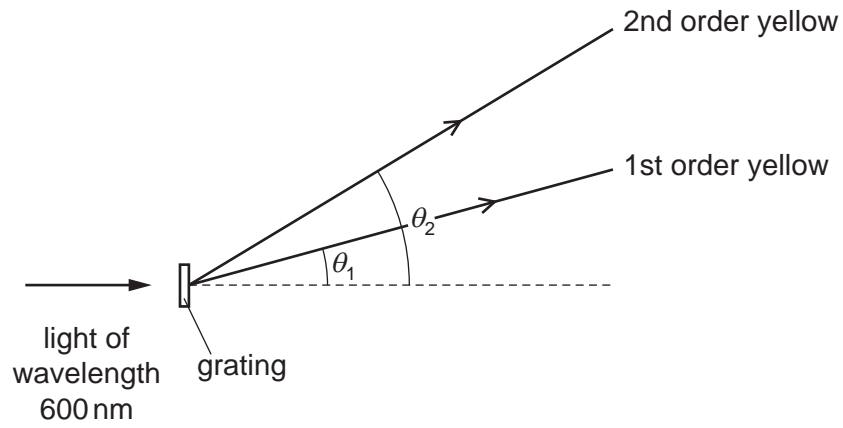

What is the angular separation ( $\theta_2 - \theta_1$ ) between the first and second order maxima of the yellow light?

- A  $17.5^\circ$       B  $19.4^\circ$       C  $36.9^\circ$       D  $54.3^\circ$

**Space for working**

- 28 The diagram shows two parallel horizontal metal plates. There is a potential difference  $V$  between the plates.

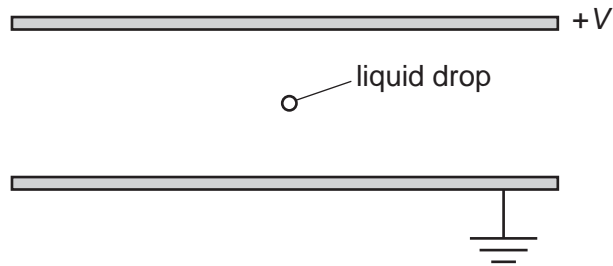

A small charged liquid drop, midway between the plates, is held in equilibrium by the combination of its weight and the electric force acting on it.

The acceleration of free fall is  $g$  and the electric field strength is  $E$ .

What is the polarity of the charge on the drop, and the ratio of charge to mass of the drop?

	polarity	$\frac{\text{charge}}{\text{mass}}$
<b>A</b>	negative	$\frac{E}{g}$
<b>B</b>	negative	$\frac{g}{E}$
<b>C</b>	positive	$\frac{E}{g}$
<b>D</b>	positive	$\frac{g}{E}$

**Space for working**

29 The diagram shows two metal plates connected to a constant high voltage.

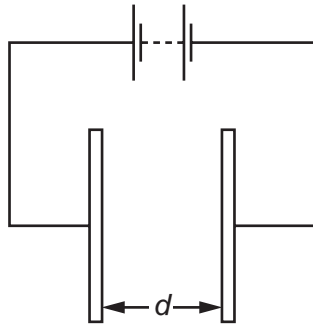

Which graph shows the variation of the electric field strength  $E$  midway between the two plates as the distance  $d$  between the two plates is increased?

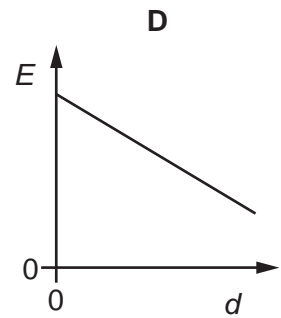
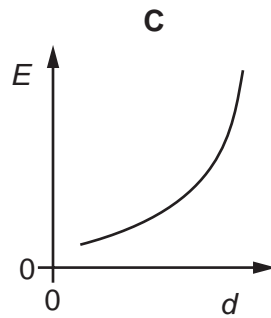
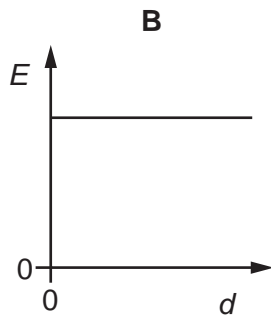
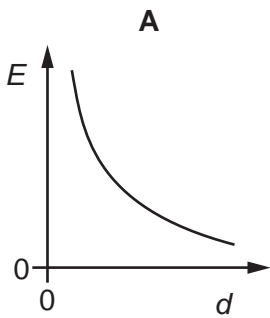

Space for working

- 30  $B_1$ ,  $B_2$  and  $B_3$  are three identical lamps. They are connected to a battery with zero internal resistance, as shown.

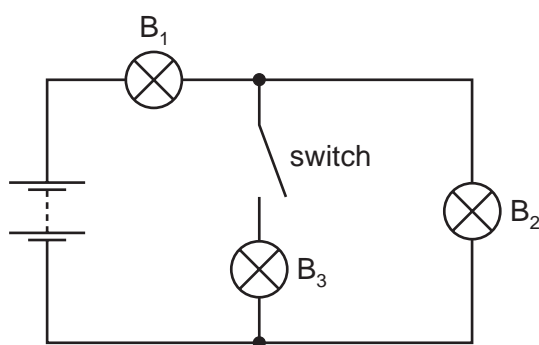

Initially the switch is closed. The switch is then opened and lamp  $B_3$  goes out.

What happens to the brightness of lamps  $B_1$  and  $B_2$  when the switch is opened?

	brightness of lamp $B_1$	brightness of lamp $B_2$
<b>A</b>	decreases	decreases
<b>B</b>	decreases	increases
<b>C</b>	increases	decreases
<b>D</b>	increases	increases

- 31 A battery is marked 9.0V.

What does this mean?

- A** Each coulomb of charge from the battery supplies 9.0J of electrical energy to the whole circuit.
- B** The battery supplies 9.0J to an external circuit for each coulomb of charge.
- C** The potential difference across any component connected to the battery will be 9.0V.
- D** There will always be 9.0V across the battery terminals.

**Space for working**

- 32 A pencil is used to draw a line of length 30 cm and width 1.2 mm. The resistivity of the material in the pencil is  $2.0 \times 10^{-5} \Omega\text{m}$  and the resistance of the line is 40 k $\Omega$ .

What is the thickness of the line?

- A  $1.25 \times 10^{-10} \text{ m}$
- B  $1.25 \times 10^{-8} \text{ m}$
- C  $1.25 \times 10^{-7} \text{ m}$
- D  $1.25 \times 10^{-5} \text{ m}$

**Space for working**

- 33 A conductor consists of three wires connected in series. The wires are all made of the same metal but have different cross-sectional areas. There is a current  $I$  in the conductor.

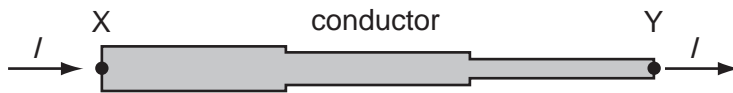

Point Y on the conductor is at zero potential.

Which graph best shows the variation of potential  $V$  with distance along the conductor?

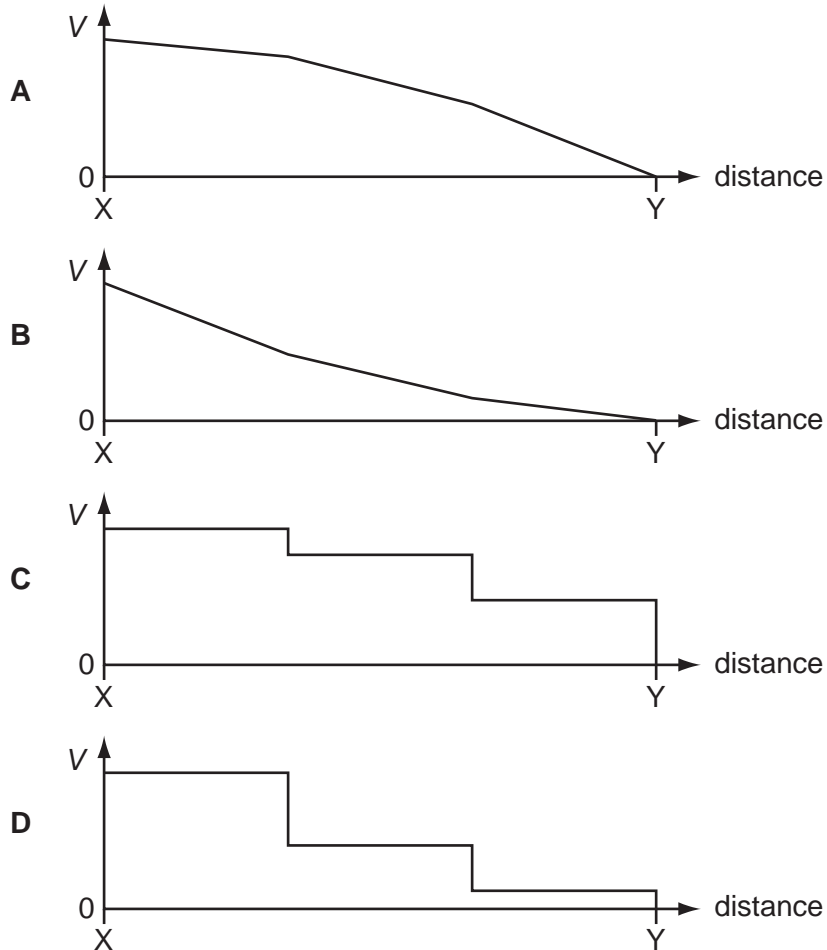

Space for working

- 34 The graph shows how the electric current  $I$  through a conducting liquid varies with the potential difference  $V$  across it.

At which point on the graph does the liquid have the smallest resistance?

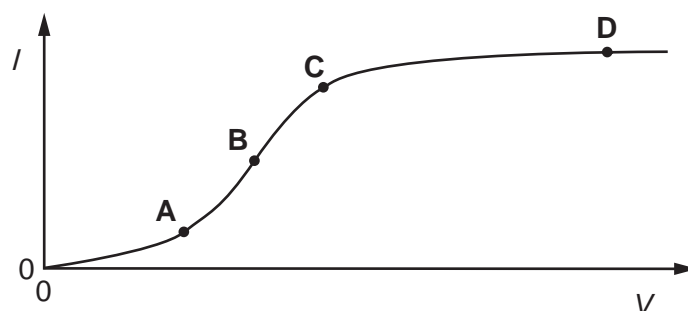

- 35 The combined resistance  $R_T$  of two resistors of resistances  $R_1$  and  $R_2$  connected in parallel is given by the formula shown.

$$\frac{1}{R_T} = \frac{1}{R_1} + \frac{1}{R_2}$$

Which statement is used in the derivation of this formula?

- A The currents through the two resistors are equal.
- B The potential difference across each resistor is the same.
- C The supply current is split between the two resistors in the same ratio as the ratio of their resistances.
- D The total power dissipated is the sum of the powers dissipated in the two resistors separately.

**Space for working**

36 In the potentiometer circuit shown, the reading on the ammeter is zero.

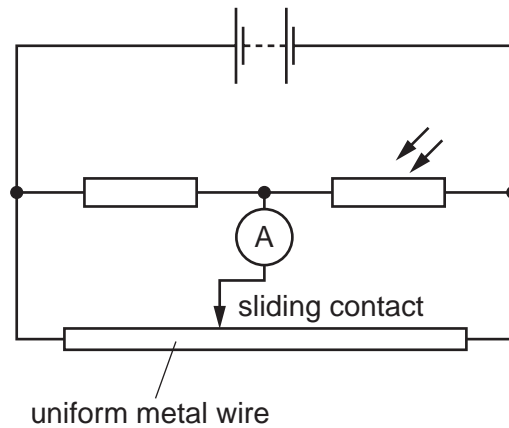

The light-dependent resistor (LDR) is then covered up and the ammeter gives a non-zero reading.

Which change could return the ammeter reading to zero?

- A Decrease the supply voltage.
- B Increase the supply voltage.
- C Move the sliding contact to the left.
- D Move the sliding contact to the right.

**Space for working**



37 Six resistors, each of resistance  $R$ , are connected as shown.

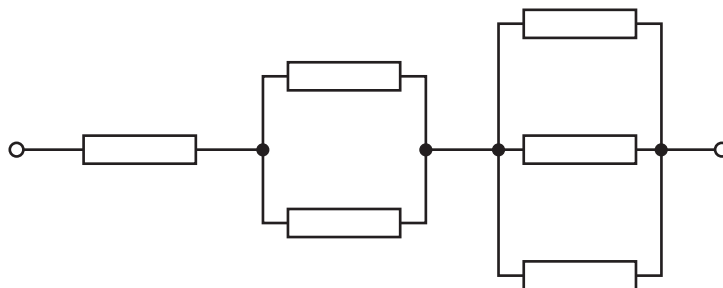

The combined resistance is  $66\text{ k}\Omega$ .

What is the value of  $R$ ?

- A**  $11\text{ k}\Omega$       **B**  $18\text{ k}\Omega$       **C**  $22\text{ k}\Omega$       **D**  $36\text{ k}\Omega$

38 Which statement about  $\alpha$ -particles is correct?

- A**  $\alpha$ -particles emitted from a single radioactive isotope have a continuous distribution of energies.
- B**  $\alpha$ -particles have less ionising power than  $\beta$ -particles.
- C** The charge of an  $\alpha$ -particle is  $+1.60 \times 10^{-19}\text{ C}$ .
- D** The speeds of  $\alpha$ -particles can be as high as  $1.5 \times 10^7\text{ m s}^{-1}$ .

**Space for working**

- 39 The isotope  ${}^{222}_{86}\text{Rn}$  decays in a sequence of emissions to form the isotope  ${}^{206}_{82}\text{Pb}$ . At each stage of the decay sequence, it emits either an  $\alpha$ -particle or a  $\beta$ -particle.

What is the number of stages in the decay sequence?

- A 4                      B 8                      C 16                      D 20
- 40 What is the approximate mass of a nucleus of uranium?
- A  $10^{-15}$  kg              B  $10^{-20}$  kg              C  $10^{-25}$  kg              D  $10^{-30}$  kg

**Space for working**



**BLANK PAGE**

---

Permission to reproduce items where third-party owned material protected by copyright is included has been sought and cleared where possible. Every reasonable effort has been made by the publisher (UCLES) to trace copyright holders, but if any items requiring clearance have unwittingly been included, the publisher will be pleased to make amends at the earliest possible opportunity.

Cambridge International Examinations is part of the Cambridge Assessment Group. Cambridge Assessment is the brand name of University of Cambridge Local Examinations Syndicate (UCLES), which is itself a department of the University of Cambridge.