



UNIVERSITY OF CAMBRIDGE INTERNATIONAL EXAMINATIONS
General Certificate of Education
Advanced Subsidiary Level and Advanced Level

PHYSICS

9702/12

Paper 1 Multiple Choice

May/June 2013

1 hour

Additional Materials: Multiple Choice Answer Sheet
Soft clean eraser
Soft pencil (type B or HB is recommended)

* 3 0 7 2 6 6 0 6 1 0 *

READ THESE INSTRUCTIONS FIRST

Write in soft pencil.
Do not use staples, paper clips, highlighters, glue or correction fluid.
Write your name, Centre number and candidate number on the Answer Sheet in the spaces provided unless this has been done for you.
DO NOT WRITE IN ANY BARCODES.

There are **forty** questions on this paper. Answer **all** questions. For each question there are four possible answers **A, B, C** and **D**.
Choose the **one** you consider correct and record your choice in **soft pencil** on the separate Answer Sheet.

Read the instructions on the Answer Sheet very carefully.

Each correct answer will score one mark. A mark will not be deducted for a wrong answer.
Any working should be done in this booklet.
Electronic calculators may be used.

This document consists of **23** printed pages and **1** blank page.



Data

speed of light in free space,	$c = 3.00 \times 10^8 \text{ m s}^{-1}$
permeability of free space,	$\mu_0 = 4\pi \times 10^{-7} \text{ H m}^{-1}$
permittivity of free space,	$\epsilon_0 = 8.85 \times 10^{-12} \text{ F m}^{-1}$
	$(\frac{1}{4\pi\epsilon_0} = 8.99 \times 10^9 \text{ m F}^{-1})$
elementary charge,	$e = 1.60 \times 10^{-19} \text{ C}$
the Planck constant,	$h = 6.63 \times 10^{-34} \text{ J s}$
unified atomic mass constant,	$u = 1.66 \times 10^{-27} \text{ kg}$
rest mass of electron,	$m_e = 9.11 \times 10^{-31} \text{ kg}$
rest mass of proton,	$m_p = 1.67 \times 10^{-27} \text{ kg}$
molar gas constant,	$R = 8.31 \text{ J K}^{-1} \text{ mol}^{-1}$
the Avogadro constant,	$N_A = 6.02 \times 10^{23} \text{ mol}^{-1}$
the Boltzmann constant,	$k = 1.38 \times 10^{-23} \text{ J K}^{-1}$
gravitational constant,	$G = 6.67 \times 10^{-11} \text{ N m}^2 \text{ kg}^{-2}$
acceleration of free fall,	$g = 9.81 \text{ m s}^{-2}$

Formulae

uniformly accelerated motion,	$s = ut + \frac{1}{2}at^2$ $v^2 = u^2 + 2as$
work done on/by a gas,	$W = p\Delta V$
gravitational potential,	$\phi = -\frac{Gm}{r}$
hydrostatic pressure,	$p = \rho gh$
pressure of an ideal gas,	$p = \frac{1}{3}\frac{Nm}{V}\langle c^2 \rangle$
simple harmonic motion,	$a = -\omega^2 x$
velocity of particle in s.h.m.,	$v = v_0 \cos \omega t$ $v = \pm \omega \sqrt{(x_0^2 - x^2)}$
electric potential,	$V = \frac{Q}{4\pi\epsilon_0 r}$
capacitors in series,	$1/C = 1/C_1 + 1/C_2 + \dots$
capacitors in parallel,	$C = C_1 + C_2 + \dots$
energy of charged capacitor,	$W = \frac{1}{2}QV$
resistors in series,	$R = R_1 + R_2 + \dots$
resistors in parallel,	$1/R = 1/R_1 + 1/R_2 + \dots$
alternating current/voltage,	$x = x_0 \sin \omega t$
radioactive decay,	$x = x_0 \exp(-\lambda t)$
decay constant,	$\lambda = \frac{0.693}{t_{\frac{1}{2}}}$

1 Which pair includes a vector quantity and a scalar quantity?

- A displacement; acceleration
- B force; kinetic energy
- C power; speed
- D work; potential energy

2 The unit of resistivity, expressed in terms of base units, is given by

$$\text{kg x}^3 \text{y}^{-2} \text{z}^{-3}.$$

Which base units are x, y and z?

	x	y	z
A	ampere	metre	second
B	metre	ampere	second
C	metre	second	ampere
D	second	ampere	metre

3 Two forces act on a circular disc as shown.

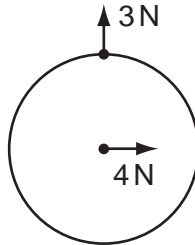

Which diagram shows the line of action of the resultant force?

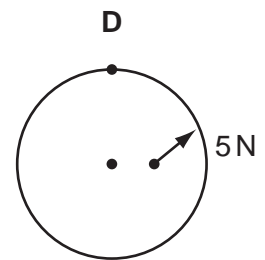
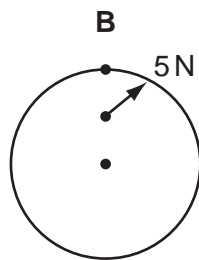
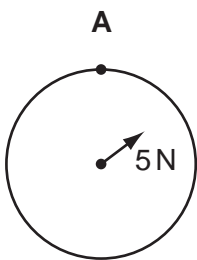

Space for working

- 4 A student carried out an experiment in which an electric current was known to decrease with time. The readings he found, from first to last, were 3.62 mA, 2.81 mA, 1.13 mA, 1.76 mA and 0.90 mA.

Which statement could **not** explain the anomalous 1.13 mA reading?

- A** He has reversed the third and fourth readings in the results table.
B He read the ammeter incorrectly; the reading should have been 2.13 mA.
C He took the current reading at the wrong time.
D There was a systematic error in the readings from the ammeter.
- 5 The diagram shows a calibration curve for a thermistor, drawn with an unusual scale on the vertical axis.

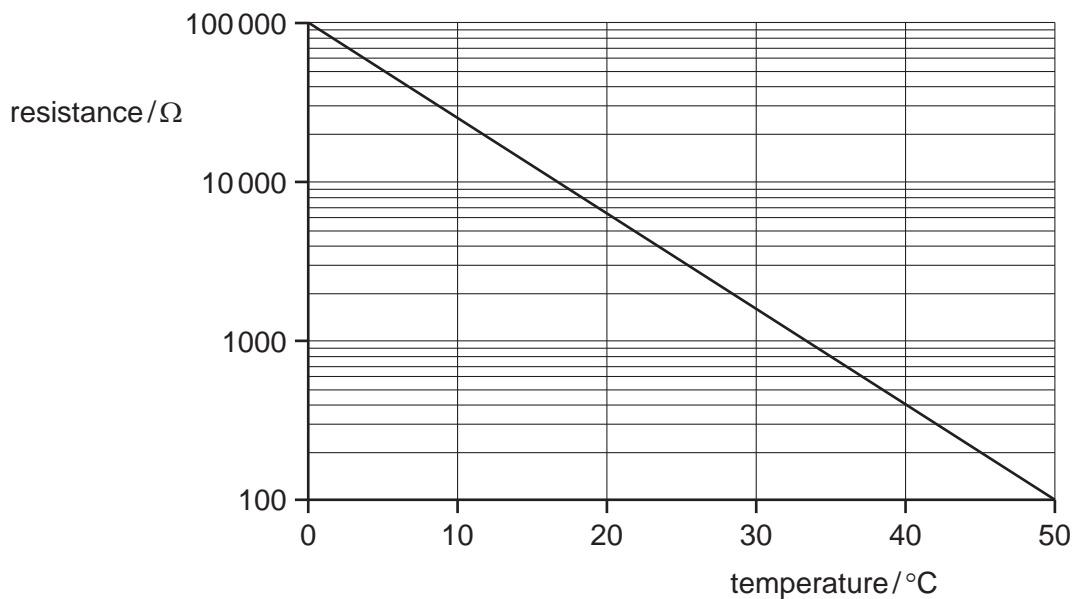

What is the thermistor resistance corresponding to a temperature of 40 °C?

- A** 130 Ω **B** 150 Ω **C** 400 Ω **D** 940 Ω

Space for working

- 6 A sky diver falls vertically from a stationary balloon. She leaves the balloon at time $t = 0$. At time $t = T$, she reaches terminal velocity. Beyond the time shown in the graphs, she opens her parachute.

Which graph shows the variation with time t of the force F due to air resistance?

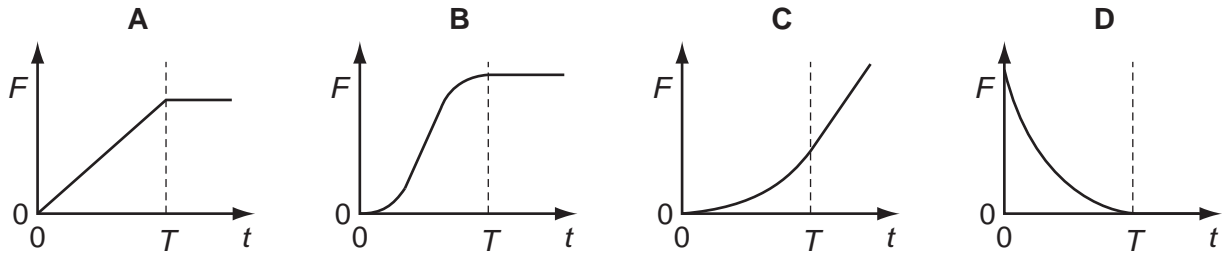

- 7 The diagram shows an arrangement to stop trains that are travelling too fast.



Trains coming from the left travel at a speed of 50 m s^{-1} . At marker 1, the driver must apply the brakes so that the train decelerates uniformly in order to pass marker 2 at no more than 10 m s^{-1} .

The train carries a detector that notes the times when the train passes each marker and will apply an emergency brake if the time between passing marker 1 and marker 2 is less than 20 s.

How far from marker 2 should marker 1 be placed?

- A 200 m B 400 m C 500 m D 600 m

Space for working

- 8 A ball is released from rest above a horizontal surface and bounces several times.

The graph shows how, for this ball, a quantity y varies with time.

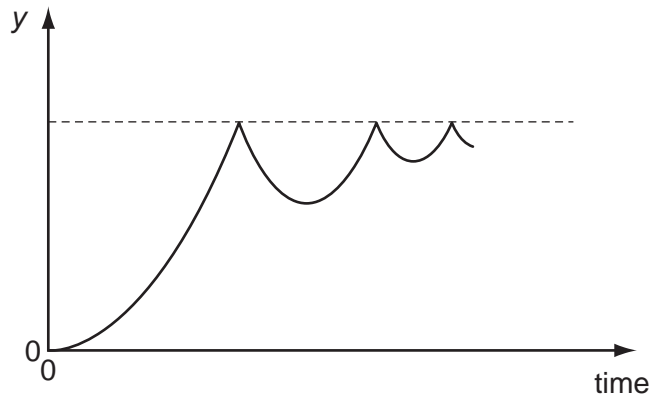

What is the quantity y ?

- A acceleration
 - B displacement
 - C kinetic energy
 - D velocity
- 9 A strong wind of speed 33 m s^{-1} blows against a wall. The density of the air is 1.2 kg m^{-3} . The wall has an area of 12 m^2 at right angles to the wind velocity. The air has its speed reduced to zero when it hits the wall.

What is the approximate force exerted by the air on the wall?

- A 330 N
- B 400 N
- C 480 N
- D 16 000 N

Space for working

- 10 Two bodies travelling in a straight line collide in a perfectly elastic collision. Which of the following statements **must** be correct?
- A The initial speed of one body will be the same as the final speed of the other body.
 - B The relative speed of approach between the two bodies equals their relative speed of separation.
 - C The total momentum is conserved but the total kinetic energy will be reduced.
 - D One of the bodies will be stationary at one instant.
- 11 A submarine is in equilibrium in a fully submerged position.

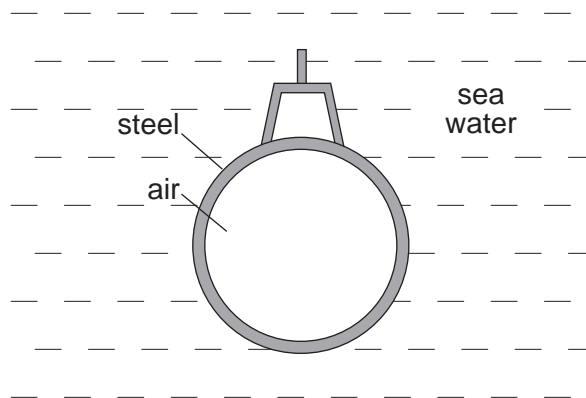

What causes the upthrust on the submarine?

- A The air in the submarine is less dense than sea water.
- B The sea water exerts a greater upward force on the submarine than the weight of the steel.
- C The submarine displaces its own volume of sea water.
- D There is a difference in water pressure acting on the top and on the bottom of the submarine.

Space for working

- 12 A vehicle is at rest on a slope. It is considered to have three forces acting on it to keep it in equilibrium.

They are its weight W , a normal reaction force R and a frictional force F .

Which triangle of forces is correct?

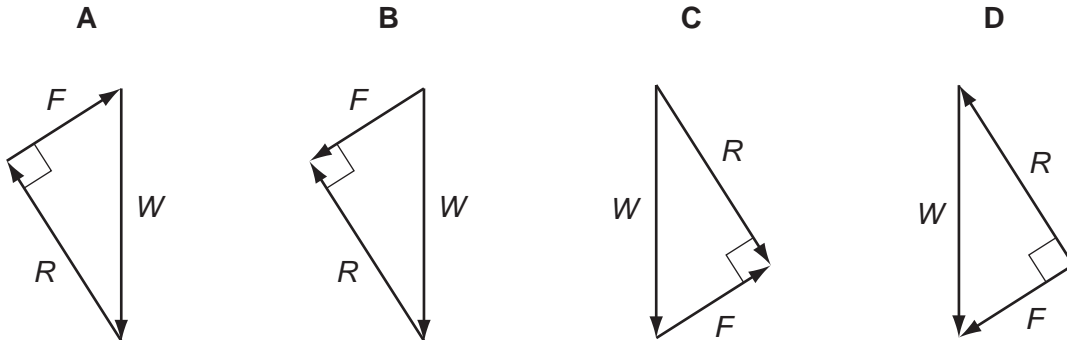

- 13 All external forces on a body cancel out.

Which statement **must** be correct?

- A The body does not move.
- B The momentum of the body remains unchanged.
- C The speed of the body remains unchanged.
- D The total energy (kinetic and potential) of the body remains unchanged.

Space for working

- 14 A uniform beam of mass 1.4 kg is pivoted at P as shown. The beam has a length of 0.60 m and P is 0.20 m from one end. Loads of 3.0 kg and 6.0 kg are suspended 0.35 m and 0.15 m from the pivot as shown.

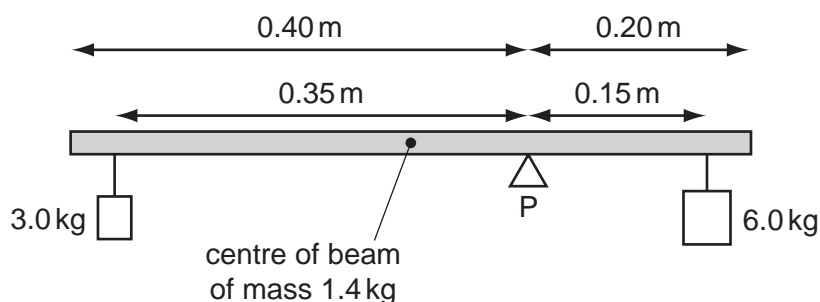

What torque must be applied to the beam in order to maintain it in equilibrium?

- A 0.010 Nm B 0.10 Nm C 0.29 Nm D 2.8 Nm
- 15 A ball is thrown vertically upwards.
- Neglecting air resistance, which statement is correct?
- A The kinetic energy of the ball is greatest at the greatest height attained.
- B By the principle of conservation of energy, the total energy of the ball is constant throughout its motion.
- C By the principle of conservation of momentum, the momentum of the ball is constant throughout its motion.
- D The potential energy of the ball increases uniformly with time during its ascent.
- 16 A bow of mass 400 g shoots an arrow of mass 120 g vertically upwards. The potential energy stored in the bow just before release is 80 J. The system has an efficiency of 28%.

What is the height reached by the arrow when air resistance is neglected?

- A 4 m B 19 m C 187 m D 243 m

Space for working

- 17 A train on a mountain railway is carrying 200 people of average mass 70 kg up a slope at an angle of 30° to the horizontal and at a speed of 6.0 m s^{-1} . The train itself has a mass of 80 000 kg. The percentage of the power from the engine which is used to raise the passengers and the train is 40%.

What is the power of the engine?

- A 1.1 MW B 2.8 MW C 6.9 MW D 14 MW
- 18 A gas is enclosed inside a cylinder which is fitted with a frictionless piston.

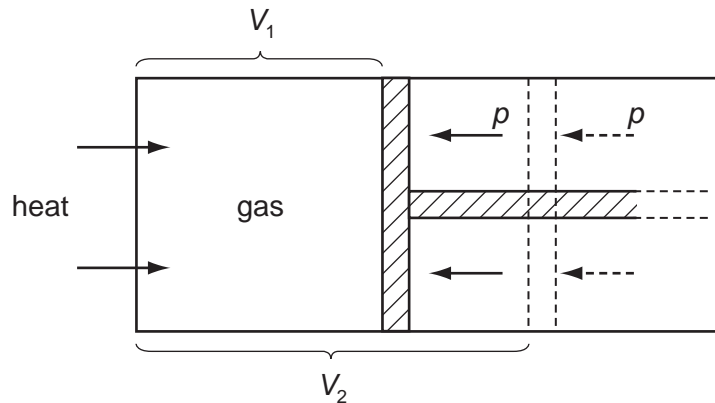

Initially, the gas has a volume V_1 and is in equilibrium with an external pressure p . The gas is then heated slowly so that it expands, pushing the piston back until the volume of the gas has increased to V_2 .

How much work is done by the gas during this expansion?

- A $p(V_2 - V_1)$ B $\frac{1}{2}p(V_2 - V_1)$ C $p(V_2 + V_1)$ D $\frac{1}{2}p(V_2 + V_1)$

Space for working

19 The diagram shows an ice cube floating in water.

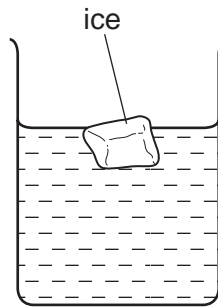

Both the ice cube and the water are at 0°C .

Which statement correctly compares the molecular properties of the ice and those of the water?

- A The mean inter-molecular potential energies are the same for both the ice molecules and the water molecules.
- B The mean inter-molecular separations are the same for both the ice and the water.
- C The mean kinetic energies are the same for both the ice molecules and the water molecules.
- D The mean total energies are the same for both the ice molecules and the water molecules.

Space for working

- 20 Two bulbs X and Y containing air at different pressures are connected by a tube P which contains two mercury threads.

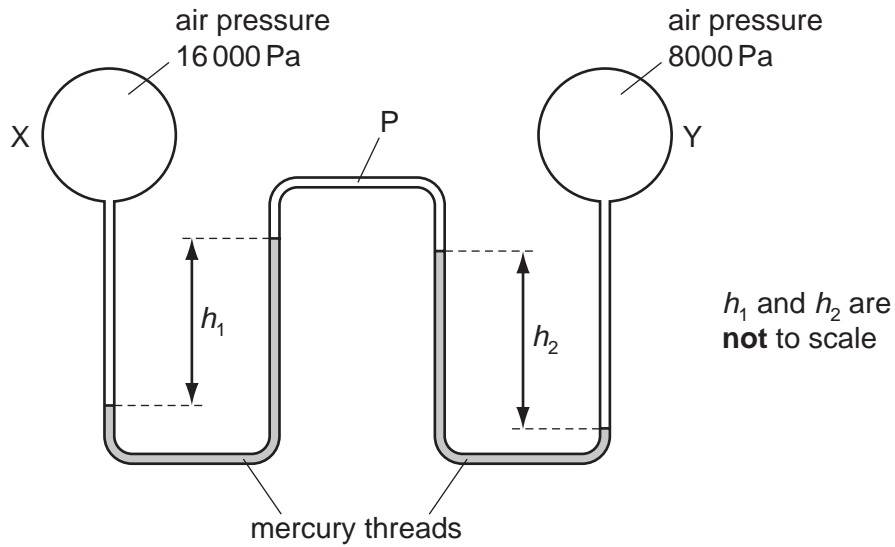

The density of mercury is $13\,600\text{ kg m}^{-3}$.

Which pair of values of h_1 and h_2 is possible?

	h_1 / cm	h_2 / cm
A	4.0	2.0
B	6.0	6.0
C	12.0	18.0
D	18.0	12.0

- 21 What is the unit of the Young modulus?

A Nm^{-1} **B** Nm **C** Nm^{-2} **D** Nm^2

Space for working

- 22 A rubber cord hangs from a rigid support. A weight attached to its lower end is gradually increased from zero, and then gradually reduced to zero.

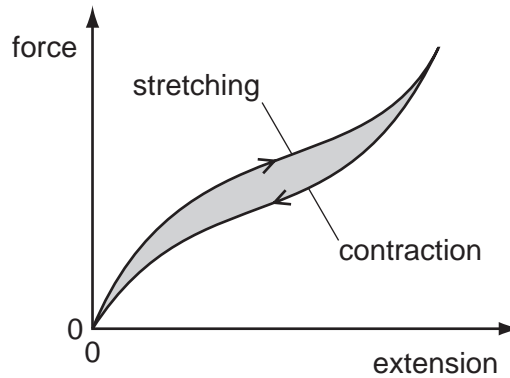
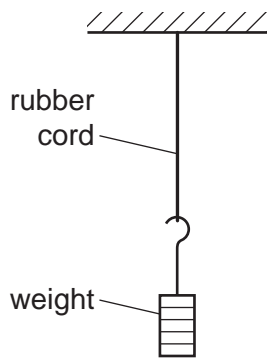

The force-extension curve for contraction is below the force-extension curve for stretching.

What does the shaded area between the curves represent?

- A the amount of elastic energy stored in the rubber
- B the amount of thermal energy dissipated in the rubber
- C the work done on the rubber cord during stretching
- D the work done by the rubber cord during contraction

Space for working

- 23 The diagram shows a large crane on a construction site lifting a cube-shaped load.

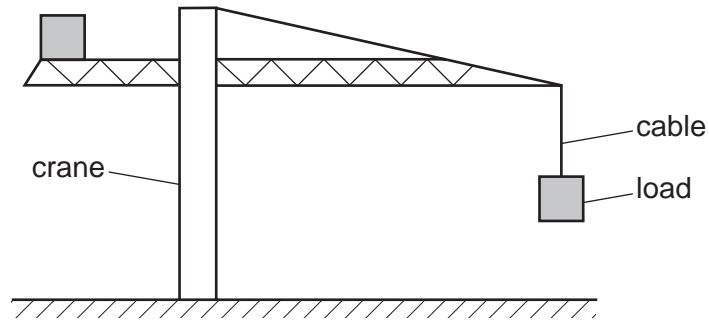

A model is made of the crane, its load and the cable supporting the load.

The material used for each part of the model is the same as that in the full-size crane, cable and load. The model is one tenth full-size in all linear dimensions.

What is the ratio $\frac{\text{stress in the cable on the full-size crane}}{\text{stress in the cable on the model crane}}$?

- A** 10^0 **B** 10^1 **C** 10^2 **D** 10^3
- 24 The order of magnitude of the frequency of the shortest wavelength of visible light waves can be expressed as 10^x Hz.

What is the value of x ?

- A** 12 **B** 13 **C** 14 **D** 15

Space for working

25 The diagram shows two waves X and Y.

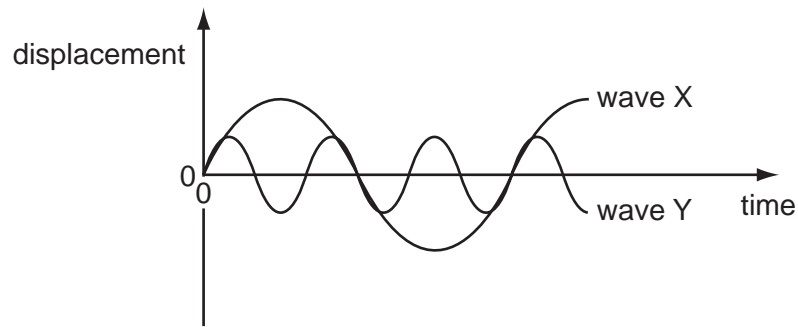

Wave X has amplitude 8 cm and frequency 100 Hz.

What are the amplitude and the frequency of wave Y?

	amplitude / cm	frequency / Hz
A	2	33
B	2	300
C	4	33
D	4	300

26 What is correct for all transverse waves?

- A** They are all electromagnetic.
- B** They can all be polarised.
- C** They can all travel through a vacuum.
- D** They all involve the oscillation of atoms.

Space for working

- 27 A transmitter of electromagnetic waves is placed 45 cm from a reflective surface.

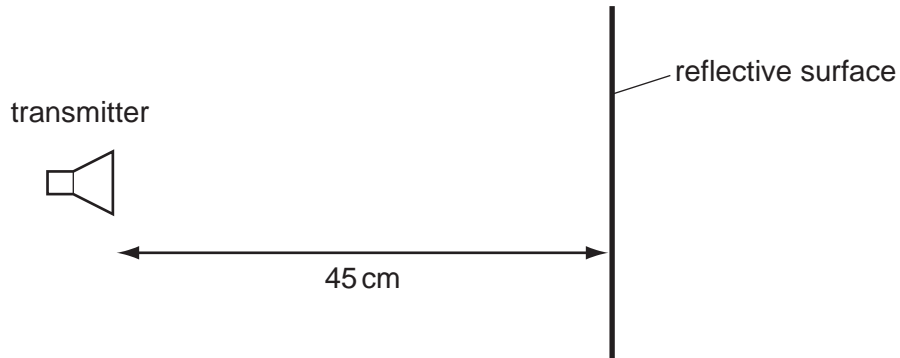

The emitted waves have a frequency of 1.00 GHz. A stationary wave is produced with a node at the transmitter and a node at the surface.

How many antinodes are in the space between the transmitter and the surface?

- A** 1 **B** 2 **C** 3 **D** 4
- 28 A teacher sets up the apparatus shown to demonstrate a two-slit interference pattern on the screen.

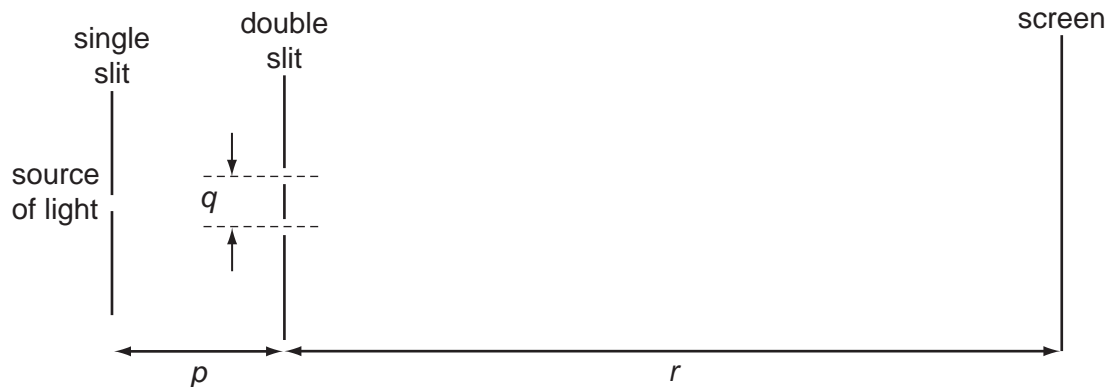

Which change to the apparatus will increase the fringe spacing?

- A** decreasing the distance p
B decreasing the distance q
C decreasing the distance r
D decreasing the wavelength of the light

Space for working

- 29 Monochromatic light of wavelength 5.30×10^{-7} m is incident normally on a diffraction grating. The first order maximum is observed at an angle of 15.4° to the direction of the incident light.

What is the angle between the first and second order diffraction maxima?

- A 7.6° B 15.4° C 16.7° D 32.0°

- 30 Two conducting layers of a liquid crystal display of a calculator are $8 \mu\text{m}$ apart. A 1.5 V cell is connected across the conducting layers when the calculator is switched on.

What is the electric field strength between the layers?

- A $1.2 \times 10^{-5} \text{ V m}^{-1}$
B 0.19 V m^{-1}
C 12 V m^{-1}
D $1.9 \times 10^5 \text{ V m}^{-1}$

Space for working

31 A positively-charged particle is projected into a uniform electric field.

Which diagram represents the path of the particle in the electric field?

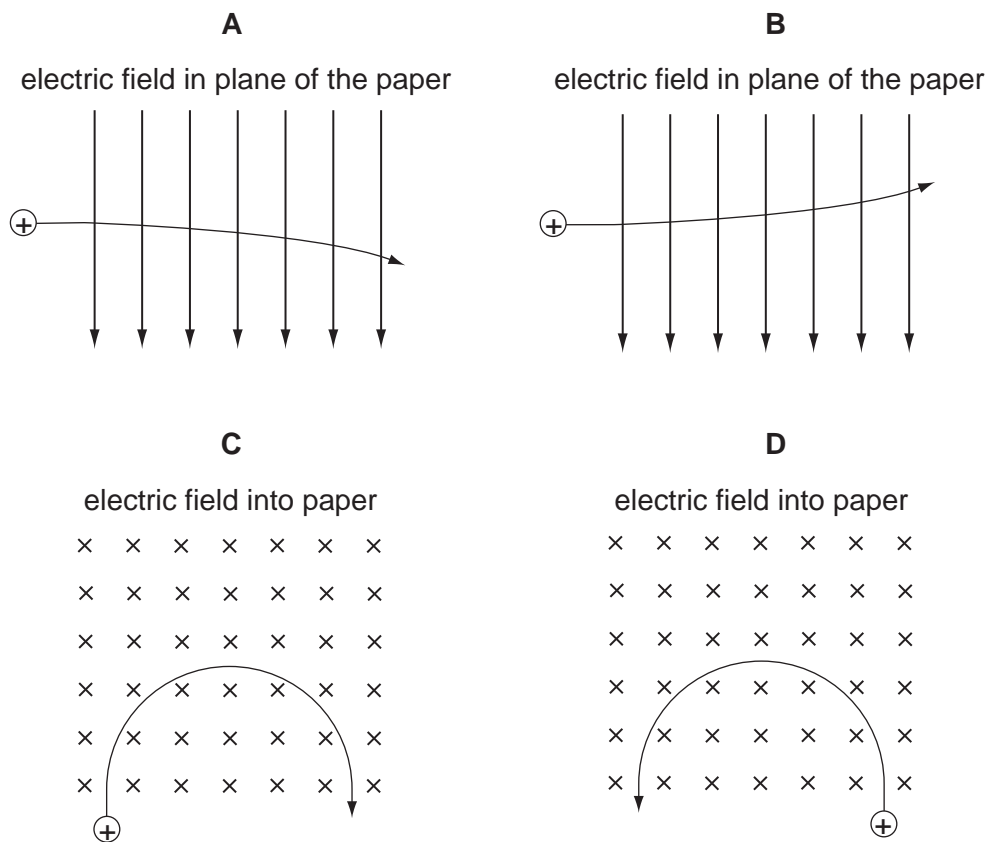

32 A power cable has length 2000 m. The cable is made of twelve parallel strands of copper wire, each with diameter 0.51 mm.

What is the resistance of the cable? (resistivity of copper = $1.7 \times 10^{-8} \Omega \text{ m}$)

- A** 0.014 Ω **B** 3.5 Ω **C** 14 Ω **D** 166 Ω

33 A low-voltage supply with an e.m.f. of 20 V and an internal resistance of 1.5 Ω is used to supply power to a heater of resistance 6.5 Ω in a fish tank.

What is the power supplied to the water in the fish tank?

- A** 41 W **B** 50 W **C** 53 W **D** 62 W

Space for working

- 34 A filament lamp has a resistance of $180\ \Omega$ when the current in it is $500\ \text{mA}$.

What is the power transformed in the lamp?

- A 45 W B 50 W C 90 W D 1400 W

- 35 Two wires P and Q made of the same material are connected to the same electrical supply. P has twice the length of Q and one-third of the diameter of Q, as shown in the diagram.

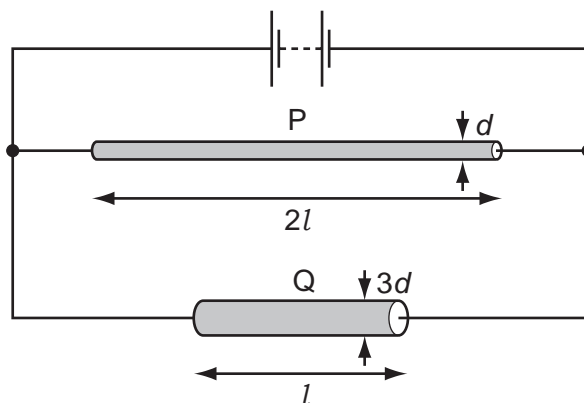

What is the ratio $\frac{\text{current in P}}{\text{current in Q}}$?

- A $\frac{2}{3}$ B $\frac{2}{9}$ C $\frac{1}{6}$ D $\frac{1}{18}$

Space for working

- 36 A 12V battery is in series with an ammeter, a 2Ω fixed resistor and a $0-10\Omega$ variable resistor. High-resistance voltmeters P and Q are connected across the variable resistor and the fixed resistor respectively, as shown.

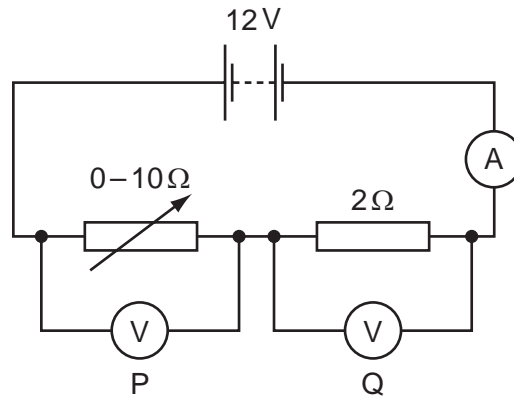

The resistance of the variable resistor is changed from its maximum value to zero.

Which graph shows the variation with current of the voltmeter readings?

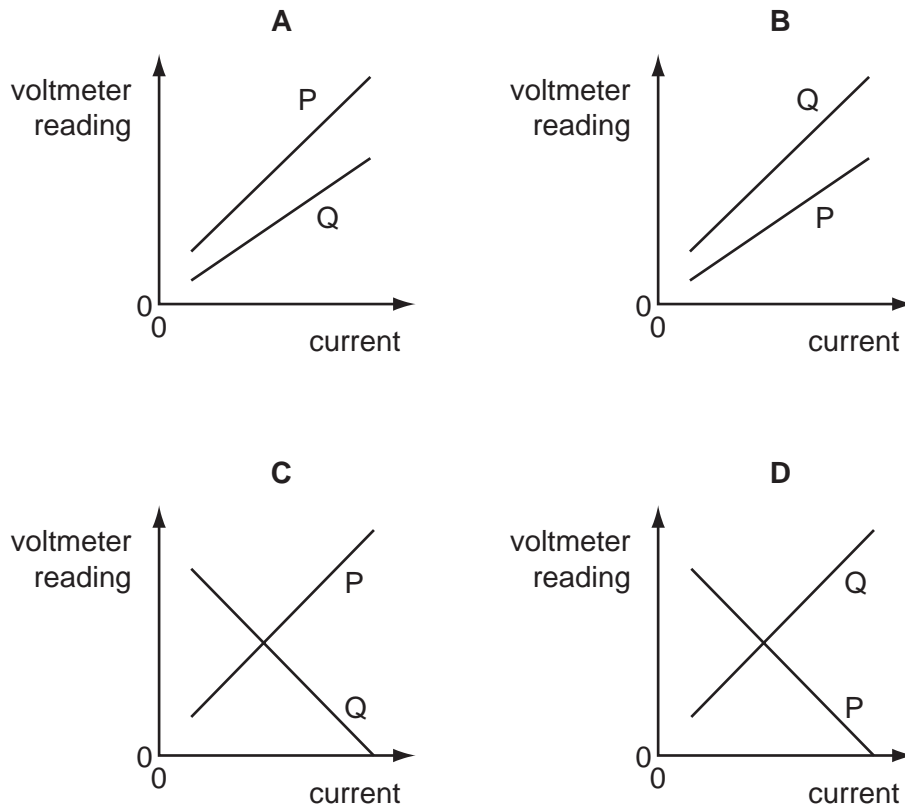

Space for working

37 Five resistors are connected as shown.

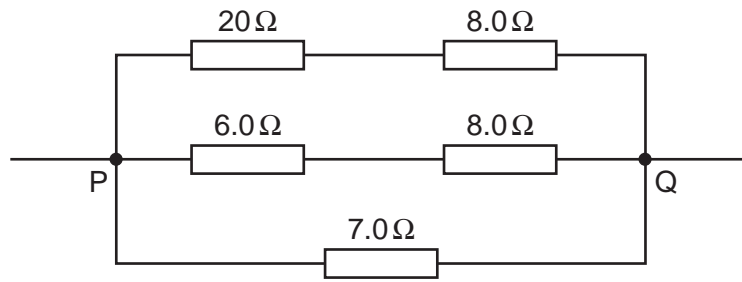

What is the total resistance between P and Q?

- A** $0.25\ \Omega$ **B** $0.61\ \Omega$ **C** $4.0\ \Omega$ **D** $16\ \Omega$

38 In the circuit below, the reading V_T on the voltmeter changes from high to low as the temperature of the thermistor changes. The reading V_L on the voltmeter changes from high to low as the level of light on the light-dependent resistor (LDR) changes.

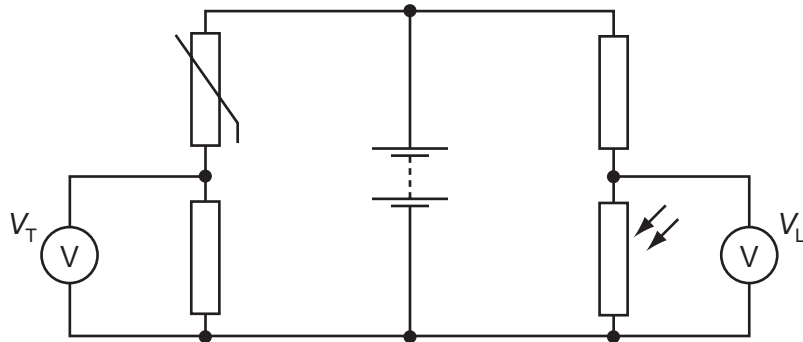

The readings V_T and V_L are both high.

What are the conditions of temperature and light level?

	temperature	light level
A	low	low
B	low	high
C	high	low
D	high	high

Space for working

39 What is the approximate mass of an alpha particle?

- A 10^{-28} kg
- B 10^{-26} kg
- C 10^{-24} kg
- D 10^{-22} kg

40 An actinium nucleus has a nucleon number of 227 and a proton number of 89. It decays to form a radium nucleus, emitting a beta particle and an alpha particle in the process.

What are the nucleon number and the proton number of this radium nucleus?

	nucleon number	proton number
A	223	87
B	223	88
C	224	87
D	225	86

Space for working

BLANK PAGE

Copyright Acknowledgements:

Question 5 © Ian Kemp; *Sample AS Question*; www.ikes.freemove.co.uk.

Permission to reproduce items where third-party owned material protected by copyright is included has been sought and cleared where possible. Every reasonable effort has been made by the publisher (UCLES) to trace copyright holders, but if any items requiring clearance have unwittingly been included, the publisher will be pleased to make amends at the earliest possible opportunity.

University of Cambridge International Examinations is part of the Cambridge Assessment Group. Cambridge Assessment is the brand name of University of Cambridge Local Examinations Syndicate (UCLES), which is itself a department of the University of Cambridge.