

GCE Examinations
Advanced Subsidiary / Advanced Level
Decision Mathematics
Module D1

Paper F

MARKING GUIDE

This guide is intended to be as helpful as possible to teachers by providing concise solutions and indicating how marks should be awarded. There are obviously alternative methods that would also gain full marks.

Method marks (M) are awarded for knowing and using a method.

Accuracy marks (A) can only be awarded when a correct method has been used.

(B) marks are independent of method marks.



Written by Shaun Armstrong & Dave Hayes

© *Solomon Press*

These sheets may be copied for use solely by the purchaser's institute.

D1 Paper F – Marking Guide

1. (a) list of 14 names \therefore mid-point = 8th = KINCARDINE
PENICUIK is after this alphabetically so reduced list is:

LARGS
MALLAIG
MONTROSE
PENICUIK
ST. ANDREWS
THURSO

list of 6 names \therefore mid-point = 4th = PENICUIK \therefore found M2 A1

- (b) list of 14 names \therefore mid-point = 8th = KINCARDINE
PENDINE is after this alphabetically so reduced list is:

LARGS
MALLAIG
MONTROSE
PENICUIK
ST. ANDREWS
THURSO

list of 6 names \therefore mid-point = 4th = PENICUIK
PENDINE is before this alphabetically so reduced list is:

LARGS
MALLAIG
MONTROSE

list of 3 names \therefore mid-point = 2nd = MALLAIG
PENDINE is after this alphabetically so reduced list is:

MONTROSE list of 1 name, not PENDINE \therefore not in list

M2 A1

- (c) it means each new list is at most half of previous list B1 (7)

2. (a) total of lengths = 96 m; $96 \div 24 = 4$ \therefore least no. of rolls = 4 A1

- (b) by inspection we have: 14, 14, 12, 8, 8, 8, 6, 6, 6, 6, 4, 4

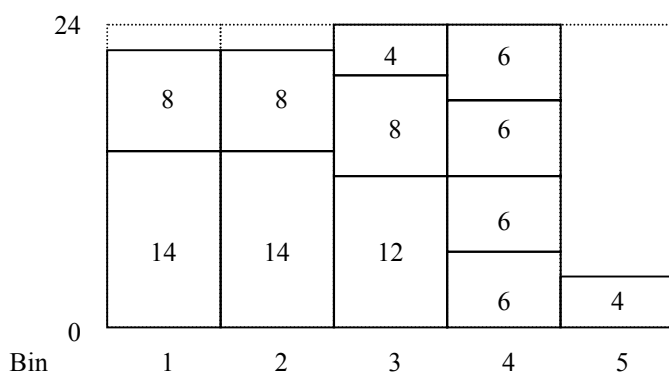

\therefore 5 rolls needed M2 A1

- (c) full-bins: (14 + 6 + 4), (14 + 6 + 4), (12 + 6 + 6) and (8 + 8 + 8) M1 A1

- (d) first-fit decreasing algorithm does not always give an optimal solution B1 (7)

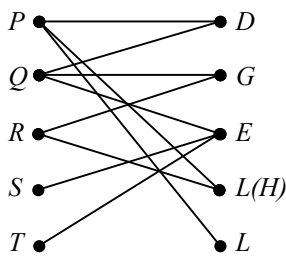
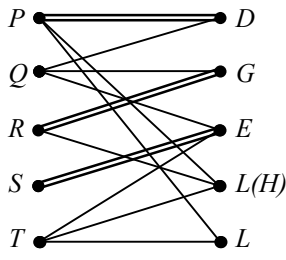
3. (a)  A1
- (b) both S and T can only be linked with E , \therefore not possible B1
- (c)  A1
- (d) initial matching shown by \equiv B1
- (e) search for alternating path giving e.g. $T-L$ (breakthrough) M1 A1
 change status giving $T=L$ M1
 alternating path e.g. $Q-D=P-L(H)$ (breakthrough) M1 A1
 change status giving $Q=D-P=L(H)$ M1
 complete matching e.g. $P-L(H), Q-D, R-G, S-E, T-L$ A1 (11)

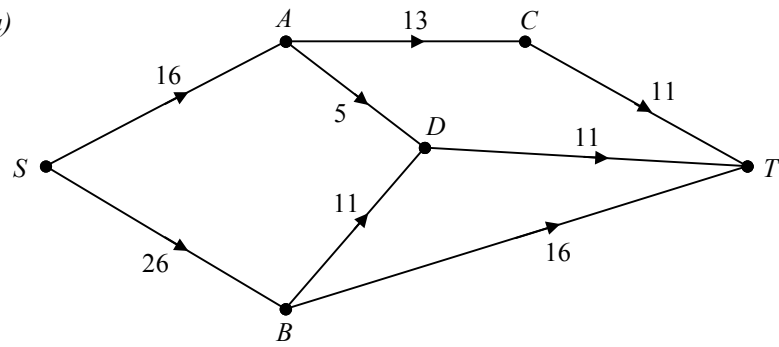
4. (a)  M1 A2
- (b) minimum cut = $\{S, A, B, C, D\} \mid \{T\} = 38$ M1 A1
- (c) e.g. augment $SACT$ by 11, SBT by 16, $SBDT$ by 10 and $SADT$ by 1, giving

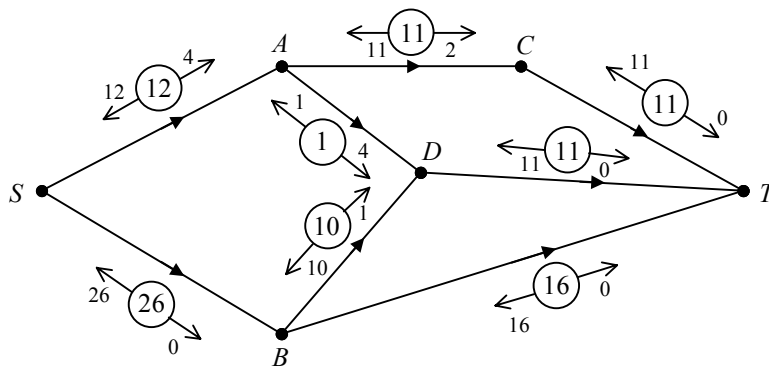

- maximum flow = 38 M2 A2
- (d) maximum as = to minimum cut A1 B1 (11)

5. (a)

x	a	b	$(a - b) < 0.01?$
100	50	26	No
-	26	14.923	No
-	14.923	10.812	No
-	10.812	10.0305	No
-	10.0305	10.00004	No
-	10.00004	10	Yes

Final Output = 10

M2 A4

(b) it finds the square root of 100

B1

(c)

x	a	b	$(a - b) < 0.01?$
100	5	12.5	Yes

e.g. it stops instead of looping because $(a - b)$ becomes negative

A1 B1

(d) $a \geq 10$

A2

(11)

6. (a) let x = no. of children and y = no. of adults

maximise $R = 50x + 100y$
 subject to $x + y \leq 90$
 $y \leq 40$
 $7x + 5y \leq 600$
 $2x + 6y \leq 300$ ($x + 3y \leq 150$)
 $x \geq 0, y \geq 0$

M2 A2

(b)

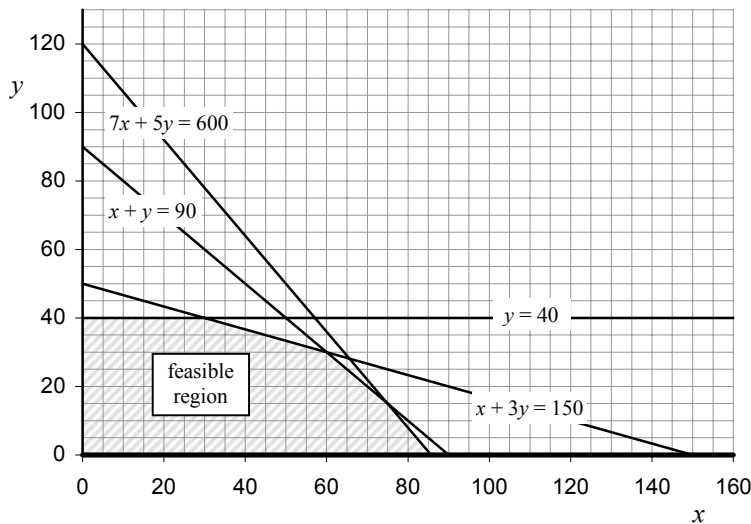

B4

(c) considering vertices / lines of constant revenue
 maximum R where $x + y = 90$ meets $x + 3y = 150$ giving $x = 60, y = 30$
 \therefore should accept 60 children and 30 adults giving revenue of £6000

M2 A2

(d) no, as the windsurfing restriction is not a factor in optimal solution

B2

(14)

7. (a)

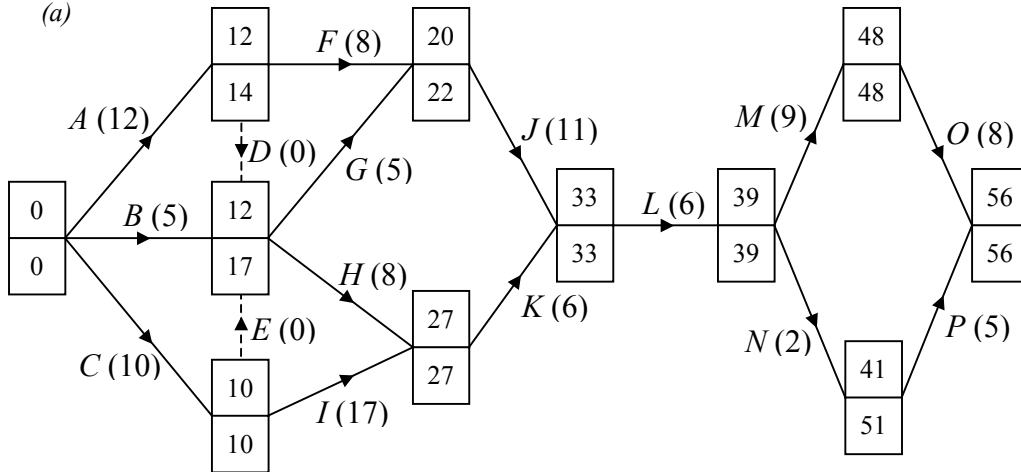

M3 A3

(b) C, I, K, L, M, O

M1 A1

(c) 56 days

A1

(d)

	0	5	10	15	20	25	30	35	40	45	50	55	60
Worker 1		C		I			K	L		M		O	
Worker 2		A		B									

with worker 1 doing tasks on critical path, worker 2 can do A and B but no worker is available to start F after 14 minutes so not possible

B2

(e) e.g.

	0	5	10	15	20	25	30	35	40	45	50	55	60
Worker 1		C		I			K	L		M		O	
Worker 2		A		F		J			N	P			
Worker 3		B		G	H								

M1 A2 (14)

Total (75)

