

**Teaching AS Chemistry
Practical Skills**



Teaching AS Chemistry Practical Skills

Your attention is drawn to the Risk Assessment section on page 15 of the Introduction to this booklet, and to the hazards indicated in Appendices 1 and 2. While every effort has been made to ensure that appropriate safety indications are given, CIE accepts no responsibility for the safety of these experiments and it is the responsibility of the teacher to carry out a full risk assessment for each experiment undertaken, in accordance with local rules and regulations. Hazard data sheets should be available from your suppliers.

Acknowledgements

Thanks are due to Chris Conoley and Brian Hildick for writing this booklet.

Contents

Introduction	1
Why should I read this booklet?	1
How much teaching time should I allocate to practical work?	1
Can I use the practicals in these booklets in a different order?	1
What resources will I need?	2
Is there a limit to the class size?	2
Why should I teach my students practical skills?	2
Points to consider	2
What are the practical skills required by this course?	3
Summary of each of the seven skills	5
Ways of doing practical work	8
Keeping records	12
How is a practical activity organised?	13
Risk assessment	15
Eye protection	16
AS skills	18
Teaching students to manipulate apparatus	18
Teaching students to make observations and measurements	18
Teaching students to record and present data and observations	19
Teaching students to analyse data and draw conclusions	20
Teaching students to evaluate procedures	21
Designing a practical course for the AS year	22
Appendix 1 – Suggested AS level practical course	23
Appendix 2 – Detailed practical lessons	39
1. Making salt – an introduction to some basic techniques	39
3. How much iron is there in an iron tablet?	45
5. What is the volume of 1 mole of hydrogen gas?	49
8. Measuring the enthalpy changes of exothermic and endothermic reactions	52
12. The effect of altering the concentration on an equilibrium reaction	57
13. Determining the value of K_c for an equilibrium reaction	61
15. The effect of temperature on reaction rate	67
21. Some redox reactions of halogens and halides	72
25. Cracking hydrocarbons	77
28. Some reactions of alcohols	81

Introduction

You may have been teaching AS and A level chemistry for many years or this may be a new experience. In either case, you will be keen to ensure that you prepare your students as effectively as possible for their examinations. Using a well-structured scheme of practical work will certainly help you to achieve this, but it can do so much more. Scientists who are thoroughly trained and experienced in practical skills will have a 'feel' for the subject and be much more confident in their own abilities than those with a purely theoretical background. While it is true that there are branches of chemistry that could be described as purely theoretical, these are in the minority. Essentially, chemistry is a practical subject and we owe it to our students to ensure that those who pursue science further have the necessary basic practical skills to take forward into their future careers. Furthermore, the basic skills of planning, analysis and evaluation will be of great value to those who pursue non-scientific careers.

Why should I read this booklet?

Some of you may be wondering why you need a booklet like this. If you have highly developed practical skills and you feel confident teaching these skills to others, you probably don't, but you might find some of the exercises described in the appendices useful. However, most of us appreciate a little help and support. This booklet aims to provide at least some of this support.

It is designed for the teacher rather than for the student. Its objective is to provide a framework within which your practical skills can develop and grow. Experience shows that as the teacher's practical skills develop, their confidence in teaching such skills increases, as does the amount of time that they will be prepared to spend on teaching practical work.

How much teaching time should I allocate to practical work?

The syllabus stipulates that 20% of teaching time should be allocated to practical work. This is in addition to any time you choose to spend on practical demonstrations to illustrate the theory syllabus. This emphasis on practical work is not misplaced. Consider the weighting given to assessment objectives in the syllabus: 24% of the award is allocated to experimental skills and investigations and 30% is allocated to handling, applying and evaluating information. Taken together, almost 55% of the total award is related to the student's ability to interpret data, understand how it has been obtained, recognise limitations and suggest explanations. All of these objectives lend themselves to investigative work involving practical experience. Even if you consider the specific practical papers in isolation, they still represent 23% of the AS or 24% of the A2 award.

In planning a curriculum, you should therefore expect to build in time for developing practical skills. If, for example, the total time allowed for this syllabus is 5 hours per week over 35 weeks, then a minimum of 1 hour per week should be built into the plan for practical work, so that over the year a minimum of 35 hours is made available – 20% of the total. Bearing in mind the emphasis on assessment objectives that relate to information handling and problem solving, a minimum of 2 hours per week might be more appropriate, which at 40% of the total time is still less than the overall weighting for these assessment objectives.

Can I use the practicals in these booklets in a different order?

It is assumed that for A level candidates, the AS work will be taught in the first year of the course and the A2 work will be covered in the second year. If you take this linear A level assessment route, you need to give careful consideration to the order in which you use the practical exercises, as the skills practised in these booklets are hierarchical in nature, i.e. the

basic skills established in the AS booklet are extended and developed in the A2 booklet. Thus, students will need to have practised basic skills from the AS exercises before using these skills to tackle more demanding A2 exercises.

The exercises in the booklets are given in syllabus order. You may, of course, decide to use a different teaching sequence, but the above point regarding AS/A2 exercises still applies.

What resources will I need?

For a practical course in A level chemistry to be successful, it is not necessary to provide sophisticated equipment. The vast majority of the practicals in these booklets can be performed using the basic equipment and materials already in the laboratory. However, some of the more advanced practicals may require less easily obtainable equipment. Alternative, 'low-tech' exercises are also provided where possible.

A list of the basic resources required for assessment can be found in the syllabus. A more detailed list can be found in the booklet *CIE Planning for Practical Science in Secondary Schools*, Appendix B.

Is there a limit to the class size?

There is a limit to the number of students that you can manage in a laboratory situation, particularly when students may be moving about. Your particular class size may, of course, be determined by the size of the room. As a general guide, however, 15 to 20 students is the maximum number that one person can reasonably be expected to manage, both for safety reasons and so that adequate support can be given to each student. Larger numbers will require either input from another person with appropriate qualifications or splitting the class into two groups for practical lessons.

Why should I teach my students practical skills?

Although teachers are likely to read this section only once, it is arguably the most important. If it convinces the 'non-practical' chemistry teacher that practical work is an essential part of chemistry and that it underpins the whole teaching programme, the aim of publishing this booklet will have been achieved.

Points to consider

- It's fun! The majority of students thoroughly enjoy practical work. The passion that many scientists have for their subject grew out of their experiences in practical classes. Students who enjoy what they are doing are likely to carry this enthusiasm over into other areas of their work and so will be better motivated.
- Learning is enhanced by participation. Students tend to find it easier to remember activities they have performed, which benefits their long-term understanding of the subject. Students who simply memorise and recall facts find it difficult to apply their knowledge to an unfamiliar context. Experiencing and using practical skills helps to develop people's ability to use information in a variety of ways, thus practical work also enables students to apply their knowledge and understanding more readily.
- Integrating practical work into the teaching programme quite simply brings the theory to life. Teachers often hear students making comments like 'I'm glad we did that practical because I can see what the book means now' and 'It's much better doing it than talking about it.'

- Chemistry, physics and biology are, by their very nature, practical subjects – both historically and in the modern world. The majority of students who enter careers in science will need to employ at least basic practical skills at some time in their career. Those who pursue non-scientific careers will also benefit from acquiring transferable practical skills and safety awareness.
- A practical course develops many cross-curricular skills, including literacy, numeracy, ICT and communication skills. It develops the ability to work both in groups and independently, and with confidence. It enhances critical thinking skills and it requires students to make judgements and decisions based on evidence, some of which may well be incomplete or flawed. It helps to make students more self-reliant and less dependent on information provided by the teacher.
- The skills developed are of continuous use in a changing scientific world. While technological advances have changed the nature of practical procedures, the investigative nature of practical science remains unchanged. The processes of observation, hypothesis formation, testing, analysing results and drawing conclusions will always be the processes used in investigative science. The ability to keep an open mind in the interpretation of data and to develop an appreciation of scientific integrity is of great value in both science and non-science careers.
- Practical work is not always easy, and persistence is required for skills to develop and for confidence to grow. Students often relish this challenge and develop a certain pride in a job well done.
- The more experience students have of using a variety of practical skills, the better equipped they will be to perform well in the practical exams, both in terms of skills and confidence. While it could be argued that the required skills could be developed for paper 3 simply by practising past examination papers, the all-round confidence in practical ability will be greatly enhanced by wider experience. Similarly for paper 5, while it could be argued that planning, analysis and evaluation can be taught theoretically, without hands-on experience of manipulating their own data, putting their plans into action and evaluating their own procedures and results, students will find this section difficult and will be at a distinct disadvantage in the examination. Those students who can draw on personal experience, and so are able to picture themselves performing the procedure they are describing or recall analysing their own results from a similar experiment, are much more likely to perform well than those with limited practical skills.

What are the practical skills required by this course?

This course addresses seven practical skills that contribute to the overall understanding of scientific methodology. In a scientific investigation these would be applied in this sequence:

- 1. Planning the experiment**
- 2. Setting up/manipulating apparatus**
- 3. Making measurements and observations**
- 4. Recording and presenting observations and data**
- 5. Analysing data and drawing conclusions**
- 6. Evaluating procedures**
- 7. Evaluating conclusions**

The syllabus shows how these seven skills are assessed, and the structure is common to all three sciences. The emphasis of the AS level syllabus is on developing an understanding of, and practice in, scientific procedures, data collection, analysis and drawing conclusions. It also starts to develop students' skills in critical evaluation of experimental procedures by asking them to suggest improvements to the procedures. In general, students find performing practical procedures and collecting data more accessible than analysis, while evaluation is the skill that is least readily accessible. To enable access to these more demanding skills, students need to understand why an experimental procedure is carried out in a particular way so that they can recognise sources of error or limitations that could affect the reliability of their results. Students will not be able to evaluate until they can critically review a practical procedure.

The A2 syllabus builds upon the skills developed at AS level. Its emphasis is on the higher-level skills of planning, analysis and evaluation. In order to plan effectively, students need to be able to evaluate procedures and critically assess results. This is best achieved by performing practical exercises, starting at AS level with relatively straightforward and familiar contexts and developing at A2 level by using more complex procedures and less familiar contexts. Data analysis also develops from AS level into more complex treatments, so students need to be provided with opportunities to gather suitable data and perform the appropriate manipulations. Evaluating conclusions and assessing procedures are very high-order skills. Students who have not had sufficient opportunity to plan and trial their own investigations will find these skills difficult. While students are not expected to be able to plan perfectly, they are expected to recognise weaknesses and make reasonable suggestions for improvement. The best learning tool for developing these skills is to devise a plan, carry out the investigation and then assess how well the planned procedure worked. The syllabus gives detailed guidance on the expected skills and learning outcomes.

In summary, Skills 2 to 6 listed above will be assessed at AS level. The first and last will only be assessed at A2 level, and A2 will also take Skills 5 and 6 to a higher level.

The above list shows the seven skills in the order in which they would be used in an extended investigation. It is not suggested that you teach these skills in this order, nor would it be wise. Students who are new to practical work will initially lack the basic manipulative skills, and the confidence to use them. It would seem sensible, therefore, to start practical training with Skill 2, initially with very simple tasks, paying attention to establishing safe working practices.

Once a measure of confidence in AS students' manual dexterity has been established, they can move on to exercises that require Skills 3 and 4 to be included. Extensive experience in carrying out practical procedures allows students to gain awareness of appropriate quantities and to become more organised in time management and recording data as it is collected.

It is likely that Skill 6, evaluating procedures, will be the most difficult to learn at AS level. Critical self-analysis does not come easily to many people. 'My experiment worked well' is a frequent response. If students are to master this skill, they need to develop an appreciation of the reliability and accuracy inherent in the equipment and procedure they are using. Only then will they be able to identify anomalous results, or results that fall outside the 'range of uncertainty' intrinsic in the apparatus they chose to use and which must therefore be considered inaccurate. Exercises with less reliable/accurate outcomes can be used to provide more scope for evaluating errors that result from procedure, technique or apparatus.

Planning is arguably the most demanding of the seven skills. For planning to be effective, students need to be very well grounded in Skills 2 to 6 so that they can anticipate the different stages involved in the task and can provide the level of detail required. It is for this reason that planning skills are not assessed at AS level but form part of the A2 assessment in paper 5. Students do not develop an understanding of how apparatus works and the sort

of measurements that can be made using particular types of apparatus unless they use it. They cannot be taught to plan experiments effectively unless, on a number of occasions, they are required to:

- plan an experiment;
- perform the experiment according to their plan;
- evaluate what they have done.

Skill 7, evaluating conclusions, is achieved by comparing the outcome of an exercise with the predicted outcome, and so is also an A2 skill. It should be taught and practised as part of the planning exercises.

Summary of each of the seven skills

Full details of the requirements for each of these skills can be found on pages 34 to 41 of the syllabus. The following is a brief summary of the skills involved.

1. Planning the experiment

- **Defining the problem**

Students should be able to use information provided about the aims of the investigation, or experiment, to identify the key variables. They should use their knowledge and understanding of the topic under consideration to make a quantitative, testable prediction of the likely outcome of the experiment.

- **Methods**

The proposed experimental procedure should be workable. Given that the apparatus has been assembled appropriately, the procedure should allow data to be collected without undue difficulty. There should be a description, including diagrams, of how the experiment should be performed and how the key variables will be controlled. Equipment, of a level of precision appropriate for the measurements to be made, and quantities of materials to be used should be specified. The use of control experiments should be considered.

- **Risk assessment**

Students should be able to carry out a simple risk assessment of their plan, identifying areas of risk and suggesting suitable safety precautions.

- **Planning for analysis, conclusions and evaluation**

Students should be able to describe the main steps by which their results will be analysed in order for valid conclusions to be drawn. This may well include generating a results table and proposing graphical methods for analysing data. They should also propose a scheme for interpreting and evaluating the results and the experimental procedure employed to obtain those results. They should indicate how the outcomes of the experiment will be compared with the original hypothesis.

2. Setting up/manipulating apparatus

It is important that students are allowed sufficient time and opportunity to develop their manipulative skills to the point where they are confident in their approach to experimental science. They must be able to follow instructions, whether given verbally, in writing or diagrammatically, and so be able to set up and use the apparatus for experiments correctly.

3. Making measurements and observations

- **Measuring/observing**

While successfully manipulating the experimental apparatus, it is crucial that students are able to take measurements with accuracy and/or to make observations with clarity and discrimination. Accurate meter or burette readings and precise descriptions of colour changes and precipitates will make it much easier for students to draw valid conclusions, and to attain a higher score in the test.

- **Deciding on what measurements/observations to make**

Time management is important, so students should be able to make simple decisions on the number and range of tests, measurements and observations that can be made in the time available. For example, if the results of the first two titrations were in good agreement, there would be no need to carry out a third.

Students need to be able to make informed decisions regarding the appropriate distribution of measurements within the selected range, which may not always be uniform, and the timing of measurements made within the experimental cycle. They should also be able to identify when repeated measurements or observations are appropriate.

They should practise the strategies required for identifying and dealing with results that appear anomalous.

4. Recording and presenting observations and data

An essential, but frequently undervalued, aspect of any experimental procedure is communicating the results to others in a manner that is clear, complete and unambiguous. It is vital that students are well practised in this area.

- **The contents of a results table**

The layout and contents of a results table, whether for recording numerical data or observations, should be decided before the experiment is performed. 'Making it up as you go along' often results in tables that are difficult to follow and do not make the best use of space. Space should be allocated within the table for any data manipulation that will be required.

- **The column headings in a results table**

The heading of each column must be clear and unambiguous. In columns that will contain numerical data, the heading must include both the quantity being measured and the units in which the measurement is made. The manner in which this information is given should conform to 'accepted practice'.

- **The level of precision of recorded data**

It is important that all data in a given column is recorded to the same level of precision, and that the level of precision is appropriate for the measuring instrument used.

- **Display of calculations and reasoning**

Where students use calculations as part of the analysis, all steps of the calculations must be displayed so that thought processes involved in reaching the conclusion are clear to a reader. Similarly, where students draw conclusions from observational data, the key steps in reaching the conclusions should be reported and should be clear, sequential and easy to follow.

- **Significant figures**

Students should be aware that the number of significant figures to which the answer is expressed shows the precision of a measured quantity. Therefore, they should take great care with regard to the number of significant figures quoted in a calculated value. The general rule is to use the same number of significant figures as (or, at most, one more than) that of the least precisely measured quantity.

- **Data layout**

Students should be able to make simple decisions concerning how best to present the data they have obtained, whether this is in the form of tabulated data or as a graph. When drawing tables, they should be able to construct the table to give adequate space for recording data or observations. When plotting graphs, they should be able to follow best practice guidelines for choosing suitable axis scales, plotting points and drawing curves or lines of best fit.

5. Analysing data and drawing conclusions

This skill requires students to apply their understanding of underlying theory to an experimental situation. It is a higher-level skill and so makes a greater demand on the student's basic understanding of the chemistry involved. Even when that understanding is present, however, many students still struggle. Presenting a clear, lucid, watertight argument does not come naturally to most people and it is therefore recommended that students have a lot of practice in this area.

- **Interpreting data or observations**

Once data has been presented in the best form for analysis of the results of the experiment, students should be able to describe and summarise any patterns or trends shown and the key points of a set of observations. Further values, such as the gradient of a graph, may be calculated or an unknown value may be found, for example from the intercept of a graph.

- **Errors**

Students should be used to looking at an experiment, assessing the relative importance of errors and, where appropriate, expressing these numerically. They should be aware of two kinds of error:

- (i) The 'error' that is intrinsic in the use of a particular piece of equipment. Although we refer to this as an equipment error, we really mean that there is a 'range of uncertainty' associated with measurements made with that piece of equipment. This uncertainty will be present no matter how skilled the operator might be.
- (ii) Experimental error, which is a direct consequence of the level of competence of the operator or of the effectiveness of the experimental procedure.

- **Conclusions**

Students should learn to use evidence to support a given hypothesis, to draw conclusions from the interpretation of observations, data or calculated values, and to make scientific explanations of their data, observations and conclusions. Whatever conclusions are drawn, they must be based firmly on the evidence obtained from the experiment. At the highest level, students should be able to make further predictions and ask appropriate questions based on their conclusions.

6. Evaluating procedures

Arguably, this is one of the most important, and probably one of the most difficult, skills for students to develop. In order for the evaluation to be effective, students must have a clear understanding of the aims and objectives of the exercise, otherwise they will not be able to judge the effectiveness of the procedures used. They must be able to evaluate whether any errors in the data obtained exceed those expected due to the equipment

used. If this is the case, they then need to identify those parts of the procedure that have generated these excess errors and suggest realistic changes to the procedure that would result in a more accurate outcome. They should also be able to suggest modifications to a procedure to answer a new question.

The evaluation procedure may include:

- (i) the identification of anomalous values, a deduction of possible causes of these anomalies and suggestions for appropriate means of avoiding them;
- (ii) an assessment of the adequacy of the range of data obtained;
- (iii) an assessment of the effectiveness of the measures taken to control variables;
- (iv) an informed judgement on the confidence with which conclusions may be drawn.

7. Evaluating conclusions

This is also a higher-level skill, which demands that students have a thorough understanding of the basic theory that underpins the science involved.

The conclusions drawn from a set of data may be judged on the basis of the strength or weakness of any support for, or against, the original hypothesis. Students should be able to use the detailed scientific knowledge and understanding they have gained in theory classes to make judgements about the reliability of the investigation and the validity of the conclusions they have drawn.

Without practice in this area, students are likely to struggle. To increase their confidence in drawing conclusions, it is recommended that practical exercises, set within familiar contexts, are used to allow students the opportunity to draw conclusions, make evaluations of procedures and assess the validity of their conclusions.

In the examination, students may be required to demonstrate their scientific knowledge and understanding by using it to justify their conclusions.

Ways of doing practical work

Science teachers should expect to use practical experiences as a way to enhance learning. Practical activities should form the basis on which knowledge and understanding are built. They should be integrated with the related theory, offering opportunities for concrete, hands-on learning rather than treated as stand-alone experiences. In planning a scheme of work, it is important to consider a mosaic of approaches that include those that allow students to participate in their own learning.

- Some practical activities should follow a well-established structure that includes a detailed protocol for students to follow. Such well-structured learning opportunities have a vital role to play in introducing new techniques, particularly in rapidly developing fields such as biotechnology. In these new areas of science, teachers often find themselves leading practical work that they did not have the chance to experience themselves as students.
- Other practical activities should offer students the opportunity to devise their own methods or to apply the methods that they have been taught to solving a problem. The excitement generated by exposure to 'new' and unfamiliar techniques provides a stimulus that will engage students' interest and challenge their thinking.

Practical activities may be used as a tool to introduce new concepts – for example, introducing catalysis by experimentation, followed up by theoretical consideration of the reasons for the unexpected results obtained. On other occasions, practical work can be

used to support and enhance the required knowledge and understanding – for example, in building upon a theoretical consideration of the limiting factors of photosynthesis with a series of practicals investigating the effect of light intensity and hydrogen carbonate concentration on photosynthesis in water weed. In all cases, learning will be enhanced most effectively by practical work that encourages students to be involved and to think, and to apply and use their knowledge, understanding and skills.

Practical work does not always have to be laboratory based. In classrooms, using models, role-play and paper cut-outs to simulate processes can be equally valuable. In biology, field studies also contribute greatly to a student's appreciation.

There are many strategies you can adopt to integrate practical work into a scheme of work. You should use a wide range of methods to enhance a variety of subject-specific skills and simultaneously develop a variety of transferable skills that will be useful throughout students' future professional lives. Some of the methods you can use to deliver practical work also enable you to interact on a one-to-one basis with individual students. This allows you to offer support at a more personal level and develop a greater awareness of an individual student's needs.

Your choice of a specific strategy will depend on issues such as class size, laboratory availability, availability of apparatus, level of competence of your students, availability and expertise of technical support, time available, your intended learning outcomes for the activity and safety considerations. The following are some possible strategies for delivering practical work:

- **Teacher demonstrations**

These require less time than a whole-class practical, but give little opportunity for students to develop manipulative skills or to become familiar with equipment. Careful planning can provide an opportunity for limited student participation. Teacher demonstrations are a valuable way of showing an unfamiliar procedure at the start of a practical session, during which students go on to use the method.

Considerations in choosing to do a demonstration **might include** the following:

- (i) **Safety** – some exercises carry too high a risk factor to be performed in groups.
- (ii) **Apparatus** – you may need to show complicated procedures or you may have limited resources.
- (iii) **Time** – demonstrations usually take less time.
- (iv) **Outcome** – some results are difficult to achieve and may be beyond the skill level of most students. A failed experiment may be seen as a waste of time.
- (v) **Students' attention** – a danger is that the attention of some students will drift.
- (vi) **Manipulative experience** – remember that with this strategy, the teacher gets experience, the students don't.

There are many good reasons for the teacher to perform a demonstration, but do be aware that most students have a strong preference for hands-on experimentation. So, where possible, let them do it!

- **Group work**

Whole-class practical sessions. These have an advantage in terms of management as all the students do the same thing. Students may work individually, in pairs or in small groups. Integrating this type of practical is straightforward as earlier lessons can be used to introduce the context and subsequent lessons can be used to draw any conclusions and develop evaluation. However, this approach may not be feasible where specialised equipment or expensive materials are in short supply.

Small-group work. This can provide a means of utilising limited resources or managing investigations that test a range of variables and require that a lot of measurements are collected. Although the same procedure may be performed, each student group collects only one or a few sets of data, which are then pooled. For example, if five concentrations of the independent variable are being tested, each of which needs to be measured at 2-minute intervals for 30 minutes, then a group of five students can each test one concentration. In biology, field studies also lend themselves to group activities as a lot of data has to be collected in a short period of time. The individual student has the opportunity to develop their subject-specific skills. Part of the teacher's role is to monitor and maintain safety and to enable and persuade reluctant learners to take part. Group work aids personal development as students must interact and work co-operatively.

Considerations might include:

- (i) **Learning** – successful hands-on work will reinforce understanding and students will also learn from each other.
- (ii) **Confidence** – this will grow with experience.
- (iii) **Awareness/insight** – this should grow with experience.
- (iv) **Team building** – this is a very desirable outcome.
- (v) **Setting out** – as all students are doing the same thing, it is easier for the technicians.
- (vi) **Confusion** – incomplete, ambiguous or confusing instruction by the teacher will result in wasted time while the instructions are clarified, and may also compromise safety and restrict learning.
- (vii) **Opting out** – some students will leave others to do the procedure and so learn very little.
- (viii) **Safety** – this could be a serious issue and constant vigilance is essential.
- (ix) **DIY** – the urge to adapt their experiments, to see 'what would happen if', must be dealt with strictly.
- (x) **Discipline** – practical time must not be allowed to become 'play time'.

Working in groups, whether as part of a whole-class situation or where groups are working on parts of a whole, is probably the preferred option for many students. At A level, however, it is highly desirable to include opportunities for students to work on their own, thus developing individual skills and independence. In paper 3, students' practical skills will be assessed on an individual basis, so each student's experience, competence and confidence are of considerable importance.

- **Circus of experiments**

A circus comprises a number of different exercises that run alongside each other. Individuals or groups of students work on the different exercises and as they complete each exercise, they move on to the next. These are a means by which limited resources can be used effectively.

There are two basic approaches. Most commonly, during a lesson a number of short activities are targeted at a specific skill. Alternatively, a number of longer practical activities are undertaken over a series of lessons, to address a variety of skills. The circus arrangement may be more difficult for the teacher to manage as the students are not all doing the same activity. This puts more pressure on the teacher as they have to cope with advising and answering questions from a variety of investigations. With circuses spread over a number of sessions, careful planning is needed to enable the teacher to engage each group of students and to maintain a safe environment. In these situations, it is useful to include at least two activities that do not involve hands-on practical work – using data response based simulations or other activities – so that the teacher can interact with the groups that need a verbal introduction or short demonstration and can monitor their activities more effectively.

Considerations might include:

- (i) **Apparatus** – if the amount of apparatus needed for an exercise is limited, students are able to use it in rotation.
 - (ii) **Awareness** – by observing their peers, students will become more aware of the pitfalls of the exercise and so will learn from the experience of others.
 - (iii) **Safety** – different exercises may well carry different safety risks, all of which need to be covered.
 - (iv) **Setting out** – students doing different exercises will make it more difficult for the technicians.
 - (v) **Opting out** – some students may be tempted to ‘borrow’ the results obtained by earlier groups.
- **Within theory lessons**
This option should be considered whenever it is viable. It is likely that the practical work will be demonstrated, as this takes less time. Given the power of visual images, including a short practical to illustrate a theoretical point will reinforce the point and so aid the learning process. It is critical, however, that the practical works correctly, otherwise the flow of the lesson will be disrupted and confidence in the theory may be undermined. The teacher should therefore practise the exercise beforehand.
 - **Project work**
Projects are a means by which a student’s interest in a particular topic, which is not always directly on the syllabus, can be used to develop investigative skills. It can also be used to access parts of the syllabus that have little laboratory-based investigation. For example, in gene technology students might use internet-based research to find examples of genetic modification and present a poster display showing the implications. This sort of investigative work can be undertaken as either an individual or a group activity. Once the project is underway, much of the work can be student-based, outside the classroom. Care is needed in selecting the topics and setting a timescale so that relevance to the syllabus context is maintained. The work can be directed towards producing posters, giving a presentation to the group or producing group or individual reports.
 - **Extra-curricular clubs**
These can play a role in stimulating scientific enquiry methods. There are a number of ways of using clubs. One is to hold the club session during the teaching day so that all students can attend. In effect, this becomes additional lesson time in which students can practise investigative skills, including laboratory work. Such laboratory work involves materials that have a cost, which must be taken into consideration. Another way is to hold a club outside the teaching day, in which case it may be voluntary. Syllabus-specific activities should therefore be limited, but such clubs offer

valuable opportunities for exciting work unrelated to syllabuses. After-school clubs could be used as a vehicle for project work that is related to science and that is of social or economic importance, for example, endangered species or local mineral resources. Students who do attend the club could be used as a teacher resource by reporting their findings in a classroom session.

Keeping records

Students often have a problem integrating the practical work with the theory. This is particularly true when a series of experiments or a long-term investigation or project is undertaken. Potential issues include the following:

- Some students use odd scraps of paper in the laboratory, which get lost or become illegible as chemicals are spilled on them. One important criterion is that students are trained to record results immediately and accurately.
- Practical procedures may be provided by the teacher, or students may write their own notes from a teacher demonstration. These notes may get lost, so students end up with results but no procedure or context.
- When results are collected over a period of time, analysis becomes isolated from the context of the investigation and may not be completed.

The key to minimising these issues is to train students into good work practices. This is particularly important in colleges where students join at the start of their A levels from a variety of feeder schools. It is also vital for students with specific learning difficulties that affect their ability to organise their work, such as dyslexia and Asperger's syndrome.

Students may be encouraged to integrate their practical notes with their theory notes and keep them all in one file. Alternatively, they may be encouraged to keep an entirely separate practical book or file. Loose-leaf files make it easy to add to their notes, but also make it easier to lose items. Exercise books can be used, but students should be encouraged to glue any protocols provided and their laboratory records into the book so that they do not get lost. Students can adopt whichever method they prefer, depending on how they learn. Whichever option they choose, they need to be encouraged to relate their investigations to the appropriate theory and to regard it as something that needs to be thoroughly assimilated.

- Integrating the materials generated by practical work with the notes from their learning of theory can be achieved by interspersing the records of investigations with the relevant section of theory. This may still require cross-referencing where work targets several learning outcomes and assessment objectives.
- Keeping a separate practical book enables students to keep records of all the practical investigations in one place. Students need training to manage practical files effectively, particularly in keeping the contexts and cross-referencing to the theory. If care is not taken to develop and maintain these skills, students may perceive practical work as something different from theory.
- An intermediate between the two extremes is to have a separate section for practical investigations within each syllabus section in the student's file, cross-referenced to the relevant theory.

How is a practical activity organised?

Preparing for practical work needs thought and organisation. The practical work may be an activity that forms part of a lesson, it may comprise an entire lesson or it may be an investigation designed to last for several lessons, but in every case, thorough preparation is a key prerequisite for success.

Practical and investigative work should be integrated into the programme of study. The scheme of work should identify appropriate practical investigative experiences for use at the most suitable time. In designing the scheme of work, you need to do the following:

- Consider the resource implications in terms of equipment and materials in stock.
- Think about the seasonal availability of materials such as organisms and the shelf-life of thermo-sensitive or hygroscopic substances, which is sometimes short.
- Consider the time taken from order to delivery of resources, the potential for damage during dispatch and the cost of materials to be obtained from local, national or international suppliers.
- In centres with a large number of students, you may need to schedule carefully. It may be possible to permit several groups to do the work simultaneously or in quick succession, or it may be essential to re-order the scheme of work for different groups so that scarce resources can be used effectively.
- Take note of national or local health and safety regulations relating to chemicals, electricity, growing micro-organisms, etc. There may also be regulations controlling use of controversial materials such as genetically modified organisms.

Once the scheme of work has been established, the next stage is to consider each practical activity or investigation. In an ideal course, you would go through each of the following stages when developing each practical exercise. In the real world, however, this is not always possible the first time you run a course, which is one of the reasons for producing this booklet. It is better to get going and do some practical work with students than to hold out for perfection before attempting anything. Obviously, all practical work should be subject to careful and rigorous risk assessment, no matter how provisional the rest of the supporting thinking and documentation.

- Decide on the aims of the work – the broad educational goals, in terms of the broad skill areas involved (e.g. planning), and the key topic areas.
- Consider the investigative skills to be developed. You should refer to the syllabus, which in the practical skills section includes learning outcomes relating to practical skill. For example, if the intended practical work is to be a planning exercise, which of the specific skills identified in the learning outcomes will be developed?
- With reference to the topics included, decide on the intended learning outcomes of the practical activity or investigation, again referring to the syllabus. For example, which of the transport learning outcomes will be achieved? In a few cases during the course, the material on which the practical is based may be unfamiliar, in which case there may be no topic-related intended learning outcomes. Thus, A2 contexts may be used for AS practicals, and topic areas not on the syllabus may be used for AS or A2 practicals.

- In addition, it is useful to assess any other context of the practical investigation. For example, is it intended as part of the introduction to a concept, to support a theory or to demonstrate a process?
- Produce a provisional lesson plan, allocating approximate amounts of time for the introduction, student activities and summarising.
- Produce and trial a student worksheet. You can use published procedures or those produced by other teachers, or you can produce your own. As a rule, schedules produced by others need to be modified to suit individual groups of students or the available equipment. It is helpful to ask students or another teacher to read worksheets before they are finalised to identify instructions that are ambiguous or use inaccessible terminology.
- Refine the lesson plan in relation to the number of students for which the investigation is intended (whole class or a small group) and the available equipment (does some have to be shared?) and materials. There are examples of lesson plans and student worksheets in Appendix 2.
- Carry out a detailed and careful risk assessment (see below) before any preparatory practical work is done, and certainly well before students do any of the practical work. You should consider:
 - the likelihood that any foreseeable accident might occur – for example, when pupils are putting glass tube through bungs, they are quite likely to break the tube and push it through their hand;
 - the potential severity of the consequences of any such accident – for example dropping a plastic dropper bottle of 0.01 mol dm^{-3} hydrochloric acid onto a desk would cause much less severe eye injuries than the same accident with a glass bottle containing 5.0 mol dm^{-3} hydrochloric acid;
 - the measures that can be taken to reduce the severity of the effect of any accident – for example, the teacher or technician preparing bungs with glass tubes before the lesson, or using eye protection such as safety spectacles during all practical work.
- Make an equipment and materials list. This may need to be in sections and should include the following information:
 - materials and apparatus per student or per group (chemicals and glassware);
 - shared equipment per laboratory (water baths, microscopes, pH meters);
 - any chemicals should include concentrations and quantities needed;
 - any equipment should include number required;
 - any hazard associated with specific chemicals or equipment should also be noted and cross-referenced to the risk assessment – sources of information about safety may be found in the syllabus (and are reproduced below);
 - the location of storage areas for equipment and chemicals, which may be cross-referenced to the equipment and materials in the list.
- Set up and maintain a filing system where master copies of the worksheets, lesson plans and equipment lists can be stored. It is helpful to have these organised, or at least indexed, by both their syllabus context and skills developed.
- Once an investigation has been used by a group of students, it should be evaluated in relation to intended outcomes and the lesson plan. It is important to obtain feedback from the students about their perceptions of the work. For example:
 - was the time allocation appropriate;
 - were the outcomes as expected;

- did they enjoy the work;
- did they understand the instructions;
- was the point of the work clear to them?

If necessary, the worksheet and lesson plan should be revised.

Risk assessment

All practical work should be carried out in accordance with the health and safety legislation of the country in which it is done. You should not attempt any activities that conflict with this legislation.

Hands-on practical work can be carried out safely in schools. However, to ensure that it is safe, you must identify the hazards and reduce any associated risks to insignificant levels by adopting suitable control measures. You should carry out these risk assessments for all the activities involved in running practical science classes, including storage of materials, preparatory work undertaken by the teacher and any technical support staff, and practical activities carried out in the classroom, whether demonstrations by the teacher or practical activities undertaken by the students. Such risk assessments should also be carried out in accordance with the health and safety legislation of the country in which you are working.

Risk assessment involves answering two basic questions:

1. **How likely is it that something will go wrong?** For example, pupils using a double-sided razor blade to cut up carrots are quite likely to cut themselves.
2. **How serious would it be if it did go wrong?** For example, the consequences of a spark from an experiment landing in an open bottle of magnesium powder are likely to be serious, and include spraying burning magnesium all over the laboratory, burning many pupils and setting the laboratory ceiling on fire (this scenario is based on a real accident).

Once you have the answers to these questions, it is possible to plan the practical activity to minimise the risk of an accident occurring and, if it does, to minimise its possible severity. In our first example, this could include cutting up the carrot before giving it to young pupils or providing older pupils with an appropriate sharp knife rather than a razor blade; in the second, it could include bringing only the amount of magnesium powder required for the activity into the laboratory.

The likelihood that something will go wrong depends on who is carrying out the activity and what sort of training and experience they have had. Obviously you would not ask 11-year-old students to heat concentrated sulphuric acid with sodium bromide or to transfer *Bacillus subtilis* cultures from one Petri dish to another, simply because their inexperience and lack of practical skills would make a serious accident all too likely. However, by the time they reach post-16, they should have acquired the skills and maturity to carry such activities out safely.

Decisions need to be made as to whether an activity should only be carried out as a teacher demonstration or whether it could be performed by students. Clearly, some experiments should normally only be done as a teacher demonstration or by older students. Well-motivated and able students may be able to carry out such an experiment at a younger age, but any deviation from the model risk assessment needs to be discussed and a written justification must be prepared beforehand.

There are some activities that are intrinsically dangerous and, if included in the suggested procedure, should always be changed to include safer modes of practice. For example,

there are **no** circumstances under which mouth pipetting is acceptable – pipette fillers of some sort should **always** be used.

Teachers tend to think of eye protection as the main control measure for preventing injury. In fact, personal protective equipment, such as goggles or safety spectacles, is meant to protect from the unexpected. If you expect a problem, more stringent controls are needed. A range of control measures may be adopted, the following being the most common. Use:

- a less hazardous (substitute) chemical;
- as small a quantity as possible;
- as low a concentration as possible;
- a fume cupboard; and
- safety screens (more than one is usually needed, to protect both teacher and students).

The importance of using the lowest possible concentrations is not always appreciated, but the following examples, showing the hazard classification of a range of common solutions, should make the point.

ammonia (aqueous)	irritant if $\geq 3 \text{ mol dm}^{-3}$	corrosive if $\geq 6 \text{ mol dm}^{-3}$
sodium hydroxide	irritant if $\geq 0.05 \text{ mol dm}^{-3}$	corrosive if $\geq 0.5 \text{ mol dm}^{-3}$
hydrochloric acid	irritant if $\geq 2 \text{ mol dm}^{-3}$	corrosive if $\geq 6.5 \text{ mol dm}^{-3}$
nitric acid	irritant if $\geq 0.1 \text{ mol dm}^{-3}$	corrosive if $\geq 0.5 \text{ mol dm}^{-3}$
sulphuric acid	irritant if $\geq 0.5 \text{ mol dm}^{-3}$	corrosive if $\geq 1.5 \text{ mol dm}^{-3}$
barium chloride	harmful if $\geq 0.02 \text{ mol dm}^{-3}$	toxic if $\geq 0.2 \text{ mol dm}^{-3}$ (or if solid)

Reference to the above table shows, therefore, that if sodium hydroxide is in common use, it should be more dilute than 0.5 mol dm^{-3} . Using more concentrated solutions requires measures to be taken to reduce the potential risk.

Material Safety Data Sheets (MSDS)

Your risk analysis should consider the hazards associated with the materials you propose to use. These risks are best assessed by reference to MSDS's appropriate to the chemical(s) in use. These are generally supplied by the chemical manufacturer and supplied with the chemical. If this is not the case then there are many internet sites that have this information freely available. These sheets also provide useful information on the actions to take following an accident, including first aid measures, and should therefore be considered essential for all practical experiments involving chemicals, as part of the risk assessment process.

Your risk assessment should not be restricted simply to the materials, procedures and equipment that will be used, but should have a wider remit that covers the time from when the students enter the room until they leave it.

Eye protection

Clearly students will need to wear eye protection. Undoubtedly, chemical splash goggles give the best protection but students are often reluctant to wear goggles. Safety spectacles give less protection, but may be adequate if nothing classed as corrosive or toxic is in use.

Practical science can be – and should be – fun. It must also be safe. The two are not incompatible.

Further relevant information on health and safety can be obtained from the following publications:

Safeguards in the School Laboratory, 10th edition, ASE, 1996

Topics in Safety, 2nd edition, ASE, 1988

Hazcards, CLEAPSS, 1998 (or 1995)

Laboratory Handbook, CLEAPSS, 1997

Safety in Science Education, DfEE, HMSO, 1996

Hazardous Chemicals Manual, SSERC2, 1997

AS skills

Teaching students to manipulate apparatus

Students gain the necessary skills of manipulating apparatus through becoming familiar with various techniques during the practical part of the course. However, skills do need to be taught and demonstrated. Manipulating some pieces of apparatus is quite complicated and it is sometimes advisable to provide short exercises to build student confidence in using certain techniques. A particular example is the skills needed to perform accurate titrations. In Appendix 2, Experiment 1 provides a simple titration to build these skills. Prior to students performing this particular experiment, you may wish to provide short exercises in using the burette and pipette, depending on their previous experience.

A useful way of showing students the different degrees of precision in volume measurement is to use a pipette and burette to deliver volumes of water into measuring cylinders. This also provides several short exercises to give students confidence in using pipettes and burettes. For example, a 10 cm³ pipette could be used to check out the accuracy of a 10 cm³ measuring cylinder. Another experiment may involve running exactly 20 cm³ of water from a burette into a 25 cm³ measuring cylinder and a 50 cm³ measuring cylinder to demonstrate the greater accuracy of a 25 cm³ measuring cylinder.

Experiment 2 extends the opportunity to perform volumetric analyses, while Experiment 3 also introduces students to the technique of using a volumetric flask to make up solutions accurately.

Teaching students to make observations and measurements

These skills are fundamental to practical work and many experiments and investigations require students to use both. As experienced scientists, we may forget that students do not automatically acquire these skills. The best way to teach students to make observations and measurements is by getting them to practise using these techniques in the context of their practical work. In this way, students come to understand that the techniques they are learning are not just necessary for examinations, but are important skills, without which chemistry could not progress.

Observational skills involve noting the detail of something. It may be a colour change or the production of bubbles of gas. Even making simple observations, a skill we, as teachers, may take for granted, needs to be developed through opportunities in a practical course.

Making measurements and understanding their accuracy is also something that students need to practise throughout their course. Students need to consider to how many decimal places a particular piece of apparatus can measure and how appropriate such measurements are. For example in Experiment 15, which concerns measuring rates of reaction, students may have access to stop watches that measure to the nearest hundredth of a second, but accuracy to the nearest second is more appropriate. Thus students should be encouraged to consider what number of decimal places to use when recording their data. This does not mean that results should arbitrarily be rounded up or down, as this will affect their reliability.

In the previous section we mentioned the techniques required for titration and suggested short exercises you could ask students to perform prior to doing Experiment 1. These short exercises could also be used to teach students how to make accurate measurements using a burette, measuring cylinder and pipette. Reading the scale with the eye level with the bottom of the meniscus is something you will need to reinforce. Fig. 1.3 in Experiment 1 provides a good illustration of why this is essential.

Burettes should be read to the nearest 0.05 cm^3 . It is possible to determine whether the bottom of the meniscus is nearer to a graduated mark or nearer to the middle of two 0.1 cm^3 marks, hence reading to the nearest 0.05 cm^3 . However, it is not possible to say precisely that a reading is, for example, 20.01 cm^3 because the closeness of the 0.1 cm^3 marks does not allow this degree of accuracy. In addition, the smallest drop that a burette can deliver is approximately 0.05 cm^3 .

The thermometer is another measuring instrument where accuracy depends on the scale. A thermometer calibrated in 1°C intervals can be read to the nearest 0.5°C , whereas another calibrated in 0.2°C intervals can be read to the nearest 0.1°C . A good experiment for exploring this is Experiment 8 in Appendix 2, where the thermometer we suggest you use is calibrated from -5°C to $+50^\circ\text{C}$, and the graduations are 0.2°C . You can ask students why this choice is preferable to a thermometer measuring from -10°C to $+110^\circ\text{C}$ in 1°C intervals.

Many measurements require a judgement to be made. This is very clear in Experiment 15, where the reaction rate between sodium thiosulphate solution and dilute hydrochloric acid is measured by timing the disappearance of a cross drawn on a piece of paper. The stopwatch is stopped when the student judges that the cross has disappeared. No matter how accurate the stopwatch, the student's judgement will affect the reliability of the data. If you ask different groups what measurements they made at the same temperature, there is likely to be a wide variation. In this case, the measurements should be made by the same individual to make them more reliable. If there is time, experiments should be repeated until they do not show too much variation to ensure reliability. In a titration with a sharp end-point, titres should be within 0.10 cm^3 .

Teaching students to record and present data and observations

There is little point in doing experiments if the results are not recorded in a systematic way. This is a skill to which students need to be introduced. Our experience, and probably yours, is that students need to be convinced that they should record results so that they can use them to draw conclusions when the experiment is over. Too often students make unintelligible scribbles, the meaning of which they think they will remember accurately for the next lesson. Getting students into the habit of recording their results is probably something that will require persistence and patience, but it is worth it.

Tables are a very good way to organise results, provided that some thought has gone into their construction, for example thinking about how many columns will be needed. Columns should be correctly labelled, with appropriate headings that describe what the data is and the units used if a measurement is involved. This also makes drawing graphs easier, since column headings can then be transferred onto axes.

In the previous section we discussed the number of decimal places that should be used. In a column of results, all the raw data should be expressed to the same number of decimal places, as this indicates that the accuracy is consistent. This is something that students need to be reminded about, quite frequently, as it is fundamental to experimental work. When data in a column is calculated, then the number of significant figures needs to be considered; this should be appropriate to the degree of accuracy of the apparatus used. This is decided by determining which of the measurements is least accurate and to what number of significant figures it is accurate. The appropriate number of significant figures to be recorded is this number, or one more than this number.

In the very first experiment in Appendix 2, students are introduced to putting their titration results in a table. In Experiments 2 and 3, they are expected to produce similar tables for their data. Check on this as you go round to different students and ensure that their tables of

results are neat. This is important because neatly recording results saves time – it prevents students needlessly having to copy out data, which could result in them copying incorrectly.

An exercise that you may wish to develop is to give students a range of different tables that have errors in them or that are constructed in an inappropriate fashion. Ask them to work in groups and suggest ways in which the tables could be improved.

Graphs are often an effective way of presenting data and demonstrating relationships and trends. Again, getting students into the right habits from the outset will pay dividends for them later. Some of the key features of drawing a graph are:

- having a title that describes what the graph represents;
- labelling the axes and including the correct units;
- plotting the independent variable on the x -axis and the dependent variable on the y -axis;
- using a sharp pencil;
- choosing a sensible scale for axes – use most of the graph paper (at least half in both dimensions) but ensure the graph is still convenient to plot;
- where data varies continuously, drawing the line of best fit;
- identifying anomalous results and not giving these undue weight.

You can really emphasise this in the rate experiments suggested in Appendix 1: Experiments 14 to 16.

Many experiments involve presenting qualitative data. This also needs to be accurately recorded in such a way that makes it easy to understand the results. If a particular experiment has several stages, then any changes, or lack of them, should be clearly identified at each stage.

Teaching students to analyse data and draw conclusions

Drawing conclusions is a skill that involves analysing the results of a practical and stating and explaining what they show.

Some conclusions are drawn from qualitative observations. In Experiment 21, the relative oxidising powers of the halogens are seen through their displacement reactions. The results are then drawn together to show a trend in oxidising power from chlorine to iodine.

Before drawing a conclusion, it may be necessary to do a calculation. It is essential to show the key steps in the working so that a competent scientist can follow the process and check the accuracy. In Experiment 1, titration readings are duplicated to ensure accuracy and to identify anomalous results. This means that an average must be calculated and the working should be shown. If there is an anomalous result, then this should not be included in the calculated average.

Processed results are often shown in graphical form. In Experiment 14 of Appendix 1, gradients can be calculated to give initial rates at time zero. These are then plotted on axes of rate (y -axis) versus concentration (x -axis). Explain to students that when calculating gradients, large triangles should be used to give a more accurate calculation.

Graphs are an excellent way of showing trends and relationships. A straight-line graph shows that there is a directly proportional relationship between the dependent and independent variables. A conclusion should always be supported by evidence from the data and in the case of the directly proportional relationship, the graph should be referred to as providing the evidence. Sometimes graphs are used to find unknown values by using co-ordinates or extrapolation. Students need to practise this skill to gain confidence in it.

Students should be encouraged to consider why data is analysed in the way that it is. For example, what is the advantage of drawing a graph over just presenting results in a table?

Teaching students to evaluate procedures

Evaluation is a skill that students do find difficult to develop. They need to think critically about the reliability of their data and the validity of their conclusions. When developing students' skills in this area, a good place to begin is to consider errors.

There are two types of error that affect results. Random errors cause results to fluctuate around a mean value and data is made more reliable by averaging repeated readings. Systematic errors affect all measurements in the same way, producing lower or higher values than the true result. These cannot be averaged out. Sometimes they are due to the particular experimental procedure that has been adopted. For example, when one person performs a rate experiment it may take time to mix the reagents and start the stop clock. This error can be minimised, or even eliminated, by using two people, one to do the timing and one to mix the reagents. Another source of systematic error may be the measuring device itself. This can be checked by seeing if two different instruments give the same values. In Experiment 8, there will be unavoidable heat losses when trying to assess enthalpy change and this causes a systematic error.

Students should be looking at experiments and assessing the relative importance of errors in measurement, or in making observations, so that they can judge which sources of error are most important. They should be able to express these errors in a standard format. For example, the measurement of volume from a burette may be $20.00 \text{ cm}^3 \pm 0.05 \text{ cm}^3$, while that from an electronic balance may be $\pm 0.01 \text{ g}$.

Experiment 4 provides a good opportunity to compare values obtained for the formula of magnesium oxide by different groups of students. The loss of magnesium oxide during flare-ups is probably the most significant source of error. If students have only one value, how can they tell how accurate their results and conclusions are?

In evaluating experiments, students should be able to do the following:

- Suggest improvements to the procedures they adopt.
- Compare repeated results to consider their similarity and thus how reliable they are.
- Identify results that are clearly anomalous.
- Identify variables that they need to control. In some experiments, students need to keep variables constant. For example in Experiment 13, 'Determining the value of K_c for an equilibrium reaction', temperature changes have a significant effect on the results, yet it is very difficult to control temperature variation over a few days without the use of a constant temperature water bath.
- Estimate uncertainty in measurement.
- Distinguish between random and systematic errors.

The above points need to be discussed at the end of experiments. Get students to suggest a checklist they could use to evaluate experiments that incorporates these ideas. Also point out to them that perfect experiments make for poor evaluation.

Designing a practical course for the AS year

We have already expounded the essential place of practical work in any chemistry course. Students develop their practical skills through being taught how to use them and then practising them.

The course we have suggested in Appendix 1 is simply that, a suggestion. There may be other experiments that you think work better or demonstrate a concept more effectively. In building our practical course we have gone through the theoretical and practical learning outcomes that need to be achieved and linked them to the syllabus. We have tried to provide a variety of approaches and to suggest practicals, where possible, with a 'real world' context. You will notice that certain skills are practised in several different experiments. For example, titration work occurs in three experiments at the outset of the course to build the necessary skills and these are reinforced in Experiments 13 and 23.

It is very tempting to drill students in the skills they need by endlessly practising past examination papers, but this provides an arid experience for them and does not relate the concepts they meet in theory to observations made through experiment. Yes, there is a place for doing past-paper work, but this should be limited to the very end of the course to reinforce the skills developed from all the varied practical work we recommend that students should carry out.

Of the 30 experiments in Appendix 1, 10 are fully worked up in Appendix 2 with Student Sheets and Teachers' Notes. The other 20 are presented in outline, in the hope that you will develop them to suit your own students and ways of working. Sometimes local circumstances mean that you cannot perform some of the experiments we suggest. In these instances, it may be possible to substitute other practicals that cover the same learning outcomes. There are several good practical textbooks that can support your course. We have featured some experiments from the Royal Society of Chemistry's books, *Classic Chemistry Experiments: One hundred tried and tested experiments* and *Classic Chemistry Demonstrations: One hundred tried and tested experiments*. What we hope comes across is how important we feel a well-constructed AS chemistry course is in developing a love of the subject and in furnishing students with the practical skills they will need to be successful both in the examination and in future practical work.

Sources

Many of the experiments listed in Appendix 1 can be found in the following books:

Classic Chemistry Experiments: One hundred tried and tested experiments, compiled by Kevin Hutchings, published by the Royal Society of Chemistry, www.rsc.org (ISBN 0 85404 9193)

Classic Chemistry Demonstrations: One hundred tried and tested experiments, compiled by Ted Lister, published by the Royal Society of Chemistry, www.rsc.org (ISBN 1 870 343 38 7)

Syllabus section	Skills/Learning Outcomes	Notes	Sources
1g, 1h	1. Making salt – an introduction to some basic techniques		
	<ul style="list-style-type: none"> Acquire skills in manipulating apparatus Acquire skills in reading a burette and using a pipette Revise use of Bunsen burner Introduction to titration Use and understand molecular and ionic equations Use the mole concept 	<p>Approximately 0.1 mol dm^{-3} solutions of hydrochloric acid (Corrosive) and sodium hydroxide (Corrosive) are used in a titration experiment to produce sodium chloride solution. The water is then evaporated to concentrate the salt solution and produce sodium chloride crystals.</p> <p>Timing: 1.5 hours if salt solution is to be evaporated</p>	Appendix 2
1h	2. Which is the best indigestion tablet?		
	<ul style="list-style-type: none"> Acquire skills in manipulating apparatus Acquire skills in reading a burette and using a pipette Make decisions relating to measurements and observations Draw conclusions Identify sources of error and suggest improvements 	<p>This experiment reinforces the techniques of titration and can be used to give students an opportunity to develop some of the skills they will need for the Practical Assessment.</p> <p>In addition to the apparatus listed in Practical 1, you will need different brands of indigestion tablet, mortars and pestles, $0.1 \text{ mol dm}^{-3} \text{ HCl}$ and methyl orange indicator.</p> <p>If the cost of each packet of tablets is known, this experiment could be used to determine which tablet represents best value. If pestles and mortars are not available, indigestion powders can be made up in advance using $\text{NaHCO}_3(\text{s})$ and $\text{NaCl}(\text{s})$.</p> <p>Timing: 1.5 hours to plan, carry out the investigation, process results and draw conclusions. This could include homework time</p>	<i>Classic Chemistry Experiments</i> , The Royal Society of Chemistry – Experiment 60

Syllabus section	Skills/Learning Outcomes	Notes	Sources
1h	3. Determining the mass of iron in iron tablets		Appendix 2
	<ul style="list-style-type: none"> • Perform a titration involving potassium manganate(VII) • Develop skills in reading a burette and using a pipette • Record results appropriately • Use and understand an ionic equation • Use the mole concept to perform calculations 	<p>This volumetric analysis is intended to further develop skills of accurate titration. It introduces a potassium manganate(VII) (Oxidising, Harmful, Dangerous to the environment) titration in an interesting context.</p> <p>Timing: One lesson for the practical and another lesson to explain the processing of the results. Approximately 1.5 hours</p>	
1f, 1h	4. Finding the formula of magnesium in magnesium oxide		<i>Classic Chemistry Experiments</i> , The Royal Society of Chemistry – Experiment 67
	<ul style="list-style-type: none"> • Acquire skills in manipulating apparatus • Acquire skills in accurate measurement • Calculate the empirical formula of magnesium oxide from reacting masses 	<p>This is a simple experiment to perform but there is much scope for experimental error. Do not worry about this, as there is a great deal of learning to be gained.</p> <p>Weigh a crucible and lid to at least two decimal places. Clean about 15 cm of magnesium with an emery cloth. Coil it round a pencil and place the loose coil in the crucible, then weigh this together with the lid. Place on a pipe-clay triangle on a tripod and heat. Lift the lid very slightly to let more oxygen in but immediately replace it to prevent magnesium oxide escaping. Do this until the magnesium no longer flares up. Remove the lid and heat strongly for 5 minutes. Allow to cool and re-weigh. The increase in mass of the magnesium is due to the oxygen that combines with it.</p> <p>Note: A typical porcelain crucible will itself react with the magnesium, leaving black 'stains'. This can be used in the discussion of results. Magnesium nitride (Mg_2N_3) may also be formed.</p> <p>Timing: 1 hour, which includes discussing the calculation</p>	

Syllabus section	Skills/Learning Outcomes	Notes	Sources
1g, 1h, 4c	5. What is the volume of 1 mole of hydrogen gas?		
	<ul style="list-style-type: none"> • Further develop skills in manipulating apparatus and accurate measurement • Use the mole concept • Calculate the molar volume at room temperature and pressure 	<p>This experiment allows students to perform a procedure to calculate the molar volume. It gives practice in calculations involving the mole concept.</p> <p>Timing: 1 hour, which includes discussing the calculation</p>	<p>Appendix 2 Also in <i>Classic Chemistry Experiments</i>, The Royal Society of Chemistry – Experiment 68</p>
4c	6. Determining the relative molecular masses of a gas		
	<ul style="list-style-type: none"> • Use the general gas equation $PV=nRT$ to determine M_r 	<p>This experiment provides a simple, quick method for finding the relative molecular mass of butane. You will need a can of butane, used for re-filling cigarette lighters. Weigh the can before the experiment and then attach a length of flexible tubing to enable 1 dm³ of the gas to be collected over water. Then dry and weigh the can again. Another possibility is to use a cigarette lighter, in which case you will not need the delivery tube – simply hold the lighter in the water trough below the measuring cylinder. This is slower and it is better to collect 250 cm³ gas – which still gives a mass loss of approximately 0.4 g. $PV=nRT$ can be used to calculate the number of moles in the known mass of gas. If you cannot measure the pressure accurately, it is worth making an educated guess.</p> <p>Timing: 30 minutes for the practical</p>	<p><i>Classic Chemistry Demonstrations</i>, The Royal Society of Chemistry – Experiment 7</p>

Syllabus section	Skills/Learning Outcomes	Notes	Sources
4e	7. The effect of heat on different substances		
	<ul style="list-style-type: none"> • Relationship between lattice structure and melting points • Sodium chloride and magnesium oxide are ionic lattices • Silicon(IV) oxide and graphite are giant molecular • Iodine and sulphur are simple molecular • Copper is a metallic lattice 	<p>This is a very simple set of experiments. Heating one or two crystals of iodine, placed in a conical flask, should be an opening demonstration as iodine is harmful and will stain skin and clothing. The iodine sublimes to give a purple vapour that turns back to crystals on cooling. Students can perform the other experiments, noting down their observations. NaCl, MgO, graphite powder and sand (which is mainly SiO₂) can be heated in hard glass test tubes. A small piece of copper can be heated with tongs and a small quantity of sulphur can be heated on a tin lid or bottle top.</p> <p>Timing: 30 minutes. This practical could be arranged as a circus</p>	<p>Most A level practical textbooks will cover something similar</p>
5b, 5c, 1h	8. Measuring the enthalpy changes of exothermic and endothermic reactions		
	<ul style="list-style-type: none"> • Further develop skills in manipulating apparatus and accurate measurement of temperature • Know that some chemical reactions are accompanied by energy changes in the form of heat energy • Know that energy changes can be exothermic (ΔH, negative) or endothermic (ΔH, positive) • Calculate enthalpy changes from your experimental results using enthalpy change = $mc\Delta T$ 	<p>This is a good experiment for introducing some of the main concepts of chemical energetics. Students do two experiments using polystyrene cups as calorimeters. Enthalpy change = $mc\Delta T$ is used to calculate the enthalpy changes of two reactions.</p> <p>Timing: 1 hour that includes discussing the calculation and a homework for completion</p>	<p>Appendix 2 Most A level practical textbooks will cover something similar</p>

Syllabus section	Skills/Learning Outcomes	Notes	Sources
5b, 5c, 1h	9. Measuring the enthalpy change of neutralisation		
	<ul style="list-style-type: none"> Determine the enthalpy change of neutralisation through experiment and calculation Explore the reason for similar values obtained for different neutralisation reactions per mole of water formed 	<p>25 cm³ of 1 mol dm⁻³ HCl is used to neutralise solutions of 25 cm³ of 1 mol dm⁻³ NaOH (Corrosive) and KOH (Corrosive) separately, using the apparatus described in Experiment 8 (Appendix 2). Following the calculation, similar values for enthalpy changes should be obtained (actual value is approximately 58 kJ mol⁻¹). As an extension, 50 cm³ of 1 mol dm⁻³ H₂SO₄ (Corrosive) could be used. This would give double the value of the above neutralisation reactions as there are 2 moles of H⁺ for every mole of H₂SO₄.</p> <p>Timing: 1 hour</p>	Most A level practical textbooks will cover something similar
6b	10. Experiments to show which ions move to the anode and cathode		
	<ul style="list-style-type: none"> Greater awareness of the properties of ions as charged particles Introduce the terms anode and cathode Explain what is happening in the electrolysis of sodium chloride solution 	<p>This is a useful introduction to electrochemistry. Cut filter paper to fit a microscope slide or watch glass. Draw a faint pencil line in the middle of the paper. Moisten it with tap water and place a crystal of potassium manganate(VII) (Oxidising, Harmful, Dangerous to the environment) on the pencil line. Connect two wires to a 6 V DC supply and attach the crocodile clips at the end of the wires on either side of the pencil line, holding the filter paper to the glass. After 10 minutes, the purple-coloured band due to the MnO₄⁻ ion moves to the anode. A similar experiment can now be done with a saturated solution of sodium chloride. This time use universal indicator paper soaked with the salt solution. The paper goes blue at the anode (due to OH⁻) and red at the cathode (due to H⁺).</p> <p>Timing: 30 minutes</p>	A similar sort of experiment is found in <i>Classic Chemistry Experiments</i> , The Royal Society of Chemistry – Experiment 15

Syllabus section	Skills/Learning Outcomes	Notes	Sources
6b	11. Electrolysing sodium chloride and copper(II) sulphate solution		
	<ul style="list-style-type: none"> Understand the electrode reactions occurring when brine (concentrated sodium chloride solution) and aqueous copper(II) sulphate are electrolysed Understand how the experiments relate to the industrial processes of the diaphragm cell and the electrolytic purification of copper 	<p>If you have access to low voltage DC sources, this is a worthwhile experiment for students to perform or for you to demonstrate. Use graphite electrodes to electrolyse a concentrated solution of sodium chloride and a copper(II) sulphate solution (Harmful, Dangerous to the environment). Also electrolyse Copper(II) sulphate using copper electrodes. The different gaseous products can be tested.</p> <p>Timing: 40 minutes</p>	<p><i>Classic Chemistry Experiments</i>, The Royal Society of Chemistry – Experiments 82 and 92 Most A level practical textbooks will also include this experiment</p>
7a, 7b	12. Introducing equilibria through two demonstrations		
	<ul style="list-style-type: none"> Understand what is meant by a reversible reaction and a dynamic equilibrium Introduce and use Le Chatelier's Principle Observe the effects of changes of concentration and temperature on the equilibrium position 	<p>Two experiments are suggested:</p> <ol style="list-style-type: none"> The equilibrium between $\text{Co}(\text{H}_2\text{O})_6^{2+}$ and CoCl_4^{2-} The equilibrium between bismuth oxide chloride and bismuth trichloride <p>Conditions are altered and are found to be as predicted by Le Chatelier's Principle.</p> <p>Timing: Each demonstration takes about 5 minutes but securing the learning outcomes from the demonstrations will require 1 hour</p>	<p>Appendix 2 <i>Classic Chemistry Experiments</i>, The Royal Society of Chemistry – Experiments 8 and 87</p>
7d, 7e, 7f	13. Determining the value of K_c for an equilibrium reaction		
	<ul style="list-style-type: none"> Deduce an expression for the equilibrium constant, K_c Calculate a value for K_c from the concentrations of substances at equilibrium Further develop skills in titration techniques 	<p>This experiment allows students to use skills they have gained from volumetric analysis to measure equilibrium concentrations for</p> $\text{CH}_3\text{COOH} + \text{C}_2\text{H}_5\text{OH} \rightleftharpoons \text{CH}_3\text{COOC}_2\text{H}_5 + \text{H}_2\text{O}$ <p>They can then determine a value for the equilibrium constant.</p> <p>Timing: 20 minutes to set up the equilibrium mixtures, which are left for a week, and 1 hour to analyse them</p>	<p>Appendix 2</p>

Syllabus section	Skills/Learning Outcomes	Notes	Sources
8a, 8b	14. The effect of concentration on the rate of a chemical reaction		
	<ul style="list-style-type: none"> Explain and use the term <i>rate of reaction</i> Follow the rate of reaction of calcium carbonate and hydrochloric acid using loss of mass of carbon dioxide Measure the effect of different concentrations on the reaction Explain the results obtained in terms of collisions Determine the gradient of a straight line graph Identify the most significant errors in this experiment 	<p>Measuring the rate of reaction using marble chips and dilute hydrochloric acid is a really good introduction to reaction kinetics. The rate can be followed using a top balance, weighing to 0.01 g. Weigh out about 10 g of large marble chips into a conical flask. Quickly add 20 cm³ of 1 mol dm⁻³ hydrochloric acid (Corrosive) and record the mass loss every 15 seconds. From this experiment, a rate curve can be drawn by plotting mass of carbon dioxide lost against time. The experiment can be repeated using other concentrations and these rate curves plotted on the same sheet of graph paper. The gradients of the graphs at time zero can be calculated. These are usually straight line graphs for the first 30 seconds at least. A graph of concentration against time can then be plotted, giving a straight line. This shows that for this reaction a straight line should be obtained.</p> <p>Timing: 1 to 2 hours</p>	Most A level practical texts will have some reference to this or a similar experiment
8c, 8d	15. The effect of temperature on reaction rate		
	<ul style="list-style-type: none"> Measure the effect of temperature on a reaction rate Represent results graphically and draw conclusions Explain, in terms of the collision theory, why temperature change affects the reaction rate 	<p>This experiment investigates the effect of temperature on the rate of reaction between sodium thiosulphate and dilute hydrochloric acid.</p> <p>Timing: 1 to 1.5 hours</p>	Appendix 2 <i>Classic Chemistry Experiments</i> , The Royal Society of Chemistry – Experiment 64

Syllabus section	Skills/Learning Outcomes	Notes	Sources
8e	16. Effect of catalysts on the reaction rate		
	<ul style="list-style-type: none"> Catalysts alter the reaction rate Catalysts are unchanged chemically at the end of the reaction Catalysts work by providing a different mechanism for the reaction 	<p>This demonstration is an effective way to introduce the role of catalysts in speeding up reactions. It shows clearly that catalysts do take part in the reaction and are unchanged chemically at the end.</p> <p>Hydrogen peroxide oxidises potassium sodium tartrate (Rochelle salt) to carbon dioxide. The reaction is slow. Adding cobalt(II) chloride (Toxic, Dangerous to the environment) causes the reaction to froth. The colour of the cobalt(II) chloride changes from pink to green to pink, showing that the reaction proceeds by an alternative mechanism.</p> <p>Timing: 5 minutes for the demonstration</p>	<p><i>Classic Chemistry Demonstrations</i>, The Royal Society of Chemistry – Demonstration 1</p>
9.1e, 9.1g	17. The reaction of oxygen with some elements in the third period		
	<ul style="list-style-type: none"> Describe the reactions of third period elements with oxygen 	<p>This demonstration examines the reactions of sodium (Corrosive, Highly flammable), magnesium, (Highly Flammable) aluminium, phosphorus (red) (Highly Flammable, Dangerous to the environment) and sulphur. Fill gas jars or boiling tubes with oxygen. Use a combustion spoon to heat very small samples of the elements. Then plunge these into the oxygen. After cooling, add water and test the pH of resulting solutions using universal indicator.</p> <p>Oxygen can be prepared using hydrogen peroxide (Caustic) and manganese(IV) oxide (Harmful) and collecting the gas over water.</p> <p>Timing: 30 minutes for the demonstration</p>	<p>Some A level practical texts will have reference to this or a similar experiment</p>

Syllabus section	Skills/Learning Outcomes	Notes	Sources
9.1e	18. The reaction of sodium and magnesium with water		
	<ul style="list-style-type: none"> Describe the reaction of sodium and magnesium with water 	<p>You should do these experiments as demonstrations. Place a very small piece of sodium (Corrosive, Highly Flammable), the size of a rice grain, in a glass trough that is a third filled with water. Cover the trough with a perspex sheet. Test the resulting solution with universal indicator. In a second experiment, trap the sodium on a piece of floating filter paper in the trough. This time the hydrogen produced catches fire. You can show the reaction of magnesium with cold water by trapping some pieces of cleaned magnesium under water in an upturned funnel feeding into a boiling tube full of water. Leave this set up for a week, which will produce 2 or 3 cm³ of hydrogen.</p> <p>Show the reaction of magnesium with steam by soaking mineral wool with water at the bottom of a test tube. Then push a coil of magnesium into the centre of the tube. Attach a delivery tube and strongly heat the magnesium. The resulting gas, collected over water, is hydrogen, which can be tested with a lighted spill.</p> <p>Timing: 30 minutes</p>	<p><i>Classic Chemistry Demonstrations</i>, The Royal Society of Chemistry – Demonstrations 72 and 75</p>

Syllabus section	Skills/Learning Outcomes	Notes	Sources
9.1e	19. Reaction of sodium with chlorine		
	<ul style="list-style-type: none"> Describe the reaction of sodium with chlorine 	<p>If you have access to a fume cupboard, this is a useful demonstration to show the formation of sodium chloride from its elements. Chlorine gas (Toxic, Irritant) can be generated from solid potassium manganate(VII) (Oxidising, Harmful, Dangerous to the environment), covered with water, onto which some concentrated hydrochloric acid (Corrosive) is added from a tap funnel in a typical gas generation apparatus. A gas jar is filled by downward displacement of air. Heat a very small piece of sodium (Corrosive, Highly Flammable) (the size of a rice grain) on a combustion spoon and plunge it into the gas jar of chlorine. Clouds of white smoke show that sodium chloride has formed.</p> <p>Timing: 15 minutes</p>	<p><i>Classic Chemistry Demonstrations</i>, The Royal Society of Chemistry – Demonstration 72</p>

Syllabus section	Skills/Learning Outcomes	Notes	Sources
9.2a, 9.2b, 9.2c	<p>20. Group II practical work</p> <ul style="list-style-type: none"> Describe the reactions of the elements with oxygen and water Describe the behaviour of the oxides with water Describe the thermal decomposition of the nitrates and carbonates 	<p>Remind students of the reaction of magnesium with oxygen and water/steam (Experiments 17 and 18).</p> <p>Experiment 1. Students can perform an experiment with a small calcium (Highly Flammable) granule in a large beaker of water and devise a method for collecting and testing the hydrogen gas produced.</p> <p>Experiment 2. Heat a lump of limestone, or marble chip, suspended from a tripod by nichrome wire, for 15 minutes. Allow to cool on a watch glass. Add one drop of cold water to the previously heated section using a thermometer and note the exothermic reaction. Add more water, drop by drop, from a dropping pipette until no further reaction occurs. Test the pH.</p> <p>Experiment 3. Warm a little solid magnesium oxide with water, filter and test the pH.</p> <p>Experiment 4. Investigate the relative stabilities to heat of magnesium carbonate, calcium carbonate and strontium carbonate. Test for carbon dioxide.</p> <p>Experiment 5. Investigate the relative stabilities of the nitrates of magnesium, calcium and strontium – this must be carried out in a fume cupboard as one of the potential products is poisonous.</p> <p>In all cases, get students to write up equations for the reactions they observe.</p> <p>Timing: 1 hour</p>	<p>Many practical texts contain references to these activities</p>

Syllabus section	Skills/Learning Outcomes	Notes	Sources
9.4f, 6a	21. Some redox reactions of halogens and halides		
	<ul style="list-style-type: none"> • Describe the relative reactivity of the elements as oxidising agents • Describe and explain the reactions of halide ions with concentrated sulphuric acid • Describe and explain redox processes in terms of electron transfer and/or changes of oxidation number 	<p>Students perform two experiments. The first looks at the displacement reactions of the halogens and the second involves the reactions of the halogens with concentrated sulphuric acid.</p> <p>Timing: This depends on the approach taken. The actual experimental work takes 30 minutes for each experiment</p>	<p>Appendix 2 <i>Classic Chemistry Experiments</i>, The Royal Society of Chemistry – Experiment 19 for the first experiment. Some practical texts contain references to these activities</p>
9.4f and Practical Assessment	22. Reactions of the aqueous halide ions – testing for halides		
	<ul style="list-style-type: none"> • Describe and explain the reactions of halide ions with aqueous silver ions followed by aqueous ammonia • Have performed the test for silver halides detailed in the Practical Assessment 	<p>These test-tube experiments give qualitative tests for halide ions.</p> <p>Experiment 1. Add five drops of silver nitrate solution (Corrosive, Dangerous to the environment) separately to solutions of sodium chloride, sodium bromide and sodium iodide. Note the appearance of the precipitates. Now add fairly concentrated ammonia solution (about 8 mol dm⁻³) (Corrosive, Dangerous to the environment). Note what happens to each precipitate.</p> <p>Experiment 2. Repeat Experiment 1 to obtain a second set of silver halide precipitates. This time leave them to stand in the light and note their appearance.</p> <p>Experiment 3. Add five drops of the three halide solutions used in Experiment 1 separately to lead nitrate solution (Toxic, Dangerous to the environment). Note the colours of the precipitates.</p> <p>Timing: 45 minutes</p>	<p><i>Classic Chemistry Experiments</i>, The Royal Society of Chemistry – Experiment 89</p>

Syllabus section	Skills/Learning Outcomes	Notes	Sources
6a, 1h and Practical Assessment	23. Reaction of iodine with sodium thiosulphate		
	<ul style="list-style-type: none"> • Carry out a titration using iodine and sodium thiosulphate • Use the results gained to verify the balanced equation for the reaction • Work out the oxidation numbers of sulphur in the sodium compounds used and produced in the reaction 	<p>This is a good place to introduce this titration. In this experiment, 10 cm³ samples of 0.010 mol dm⁻³ iodine solution are titrated with 0.010 mol dm⁻³ sodium thiosulphate solution, which is delivered from a burette. The end point can be made clearer by adding starch solution when the iodine is a pale straw colour.</p> <p>Students could be asked to see if their results are consistent with the equation for the reaction</p> $2\text{Na}_2\text{S}_2\text{O}_3(\text{aq}) + \text{I}_2(\text{aq}) \rightarrow 2\text{NaI}(\text{aq}) + \text{Na}_2\text{S}_4\text{O}_6(\text{aq})$ <p>It is also a useful exercise to ask students to work out the oxidation numbers of sulphur in the sodium compounds in the equation.</p> <p>Timing: 1 hour</p>	<p>Most A level practical texts will contain reference to this volumetric analysis</p>
10.2a, 10.2b, 10.2c, 10.2h	24. Experimenting with alkanes		
	<ul style="list-style-type: none"> • Awareness of unreactivity of alkanes • Combustion reaction of alkanes • Substitution reactions of bromine 	<p>This is very useful as an introduction to organic compounds and it is worth spending time going through the safety aspects, such as what the various hazard-warning symbols mean. Small samples of hexane (Highly Flammable, Harmful, Dangerous to the environment) are used.</p> <p>Experiment 1. Dip a combustion spoon into 2 cm³ hexane in a boiling tube and stopper the tube. Burn this in a Bunsen flame, well away from the stoppered boiling tube.</p> <p>Experiments 2 to 6. These investigate the reaction of hexane with (i) bromine water (Highly Toxic, Corrosive, Dangerous to the environment) in the dark (ii) bromine water in sunlight (iii) dilute acidified aqueous potassium manganate(VII) (Oxidising, Harmful, Dangerous to the environment) (iv) two drops of concentrated sulphuric acid (Corrosive) (v) 1 cm³ dilute potassium hydroxide (Corrosive).</p> <p>Timing: 45 minutes</p>	<p>Many A level practical books contain references to these experiments</p>

Syllabus section	Skills/Learning Outcomes	Notes	Sources
10.2g	25. Cracking hydrocarbons		Appendix 2 <i>Classic Chemistry Experiments</i> , The Royal Society of Chemistry – Experiment 96
	<ul style="list-style-type: none"> Understand the importance of cracking large hydrocarbon molecules to produce more useful alkanes and alkenes of smaller M_r Have continued to develop manipulative and observational skills 	In this experiment, the molecules to be cracked are vaporised over a heated catalyst. The gas produced is collected over water. The experiment is a good test of manipulation and observation. Timing: 1 hour	
10.2d	26. Experimenting with alkenes		Many A level practical books contain references to these experiments
	<ul style="list-style-type: none"> Combustion reaction Addition of halogens Oxidation by cold, dilute manganate(VII) to form the diol 	Cyclohexene (Highly Flammable, Harmful, Dangerous to the environment) is a convenient alkene to use. Experiments similar to the ones carried out with alkanes in Experiment 24 can be performed, omitting the experiment with potassium hydroxide solution. If desired, the potassium manganate(VII) can be made alkaline using aqueous sodium carbonate. In this case, the diol is still formed but a green coloration followed by a brown precipitate will be seen. Timing: 45 minutes	

Syllabus section	Skills/Learning Outcomes	Notes	Sources
10.3a, 10.3b, 10.3c	27. Some reactions of the halogenoalkanes	<p>These experiments are designed to show the different rates of hydrolysis caused by different halogen atoms and different carbon structures. A further experiment shows that alcoholic alkali causes elimination.</p> <p>Experiment 1. Add three drops each of 1-chlorobutane, (Highly Flammable) 1-bromobutane (Irritant, Highly Flammable, Dangerous to the Environment) and 1-iodobutane (Harmful) to 1 cm³ ethanol (Highly Flammable) in three test tubes. Then react the solutions with 0.02 mol dm⁻³ aqueous silver nitrate. Immediately put the test tubes in hot water. Note the rate of appearance of silver halide precipitates.</p> <p>Experiment 2. Repeat the method used in Experiment 1, only this time change the carbon skeleton by using three drops each of 1-chlorobutane (primary), 2-chlorobutane (secondary) and 2-chloro-2-methylpropane (Highly Flammable) (tertiary). Note the rate of appearance of silver chloride precipitate. These three halogenoalkanes are highly flammable.</p> <p>Experiment 3. Show elimination by using 2 cm³ 20% potassium hydroxide (Corrosive) in ethanol (Highly Flammable) soaked into mineral wool using the apparatus in Experiment 25 (without the aluminium oxide). Ethene gas is collected which can be tested using dilute (pale yellow) bromine water.</p> <p>Timing: 1 hour</p>	<p>Many A level practical texts will contain references to these experiments</p>

Syllabus section	Skills/Learning Outcomes	Notes	Sources
10.4a, 10.4b	28. Some reactions of alcohols		
	<ul style="list-style-type: none"> Combustion reaction of alcohols Reaction of alcohols with sodium Oxidation of ethanol to ethanal and ethanoic acid Dehydration of alcohols to alkenes Reaction of alcohols with carboxylic acids to form esters 	<p>These experiments introduce students to some reactions of the alcohol functional group.</p> <p>Timing: At least 1 hour. This is likely to be spread over two 1-hour practical sessions</p>	<p>Appendix 2 <i>Classic Chemistry Experiments</i>, The Royal Society of Chemistry – Experiment 79 for Experiments 1 and 3 Most A level practical texts</p>
10.5c, 10.5d	29. Testing for, and deducing the nature of, carbonyl compounds		
	<ul style="list-style-type: none"> Describe the use of 2,4-dinitrophenylhydrazine (2,4-DNPH) to detect the presence of carbonyl compounds Deduce the nature of an unknown carbonyl compound using Fehling's and Tollen's reagents 	<p>Experiment 1. Test 3 drops of propanone (Highly Flammable) and 3 drops of propanal (Highly Flammable Harmful) separately with 5 cm³ 2,4-DNPH (Corrosive, Toxic and Highly Flammable).</p> <p>Experiment 2. Test 10 drops of propanone and 10 drops propanal separately with 3 cm³ Fehling's solution (Corrosive and Toxic).</p> <p>Experiment 3. Test 10 drops of the aldehyde and ketone with 3 cm³ freshly prepared Tollen's reagent.</p> <p>Timing: 45 minutes</p>	<p>Many A level practical books provide information about how to make up Tollen's solution and Fehling's solution</p>
10.6b	30. Some reactions of ethanoic acid to form salts		
	<ul style="list-style-type: none"> Describe the reactions of carboxylic acids in the formation of salts 	<p>Show the reactions of the weak acid, ethanoic acid (Corrosive) (0.05 mol dm⁻³). Use universal indicator paper to show neutralisation with</p> <p>(i) sodium carbonate solution (0.4 mol dm⁻³) (ii) sodium hydroxide solution (0.4 mol dm⁻³) (Corrosive).</p> <p>Add a small piece of magnesium ribbon (Highly Flammable) to 2 cm³ of the above acid and test the gas evolved for hydrogen.</p> <p>Timing: 30 minutes</p>	<p><i>Classic Chemistry Experiments</i>, The Royal Society of Chemistry – Experiment 78</p>

1. Making salt – an introduction to some basic techniques – Student Sheet

This practical is intended to help you become confident in some of the skills you may have used in your previous chemistry course. It will also help you revise some concepts and learn new ones.

Intended lesson outcomes

By the end of this practical you should be able to:

- manipulate apparatus successfully;
- read a burette and use a pipette;
- use a Bunsen burner;
- carry out a titration experiment;
- record your titration results in the tables provided;
- use and understand molecular and ionic equations;
- use the mole concept.

Background information

An acid neutralises a base to form a salt and water. Hydrochloric acid and sodium hydroxide are completely ionised in water. We say they are a strong acid or base because they are completely ionised in solution. The ions present in hydrochloric acid are $\text{H}^+(\text{aq})$ and $\text{Cl}^-(\text{aq})$ and in sodium hydroxide are $\text{Na}^+(\text{aq})$ and $\text{OH}^-(\text{aq})$.



You are going to use the technique of **titration** to produce a sodium chloride solution.

Titration is a very accurate way of investigating the reaction of two solutions. It can be used to analyse the amount of a particular substance in a solution. This is known as **quantitative analysis**. In a titration, one solution is placed in a burette and the other is placed in a conical flask using a pipette. The solution in the burette is then run into the conical flask until there is a complete reaction. In this case you will completely neutralise a solution of hydrochloric acid with sodium hydroxide solution. You will use an indicator to tell you when there is complete neutralisation. The indicator changes colour at the exact point of neutralisation. In this case you may use any acid-base indicator because you will be titrating a strong acid with a strong base.

Questions

- Write the word and symbol equation for the reaction of hydrochloric acid with sodium hydroxide.
 - Write the equation again, this time using the ion symbols.
 - Only two of the ions you have written in 1(b) take part in the neutralisation reaction. Write the neutralisation equation without the **spectator ions**. The spectator ions are those that appear on both sides of the equation.
 - Sodium hydroxide is a soluble base. What is the name given to soluble bases?

Safety

	You must wear eye protection throughout this experiment.
	Sodium hydroxide and hydrochloric acid are corrosive . (Although the solutions are very dilute, you should mop up any spillages and rinse any solution off your skin or clothing with water).

Always use a pipette filler, or other suitable safety device. Never be tempted to use your mouth to draw liquid into the pipette.

Procedure

1. Rinse two beakers with deionised water. Label one beaker *alkali* and wash this out with a little of the 0.1 mol dm^{-3} sodium hydroxide solution. Do this twice to ensure that any water used during the rinsing of the beaker will not dilute the sodium hydroxide solution you are about to put in the beaker. Fill the beaker about half full with the sodium hydroxide solution.

Now label the other beaker *acid* and after rinsing with water, wash it out twice using small volumes of hydrochloric acid before filling this half full with the acid solution. At the moment you do not know the exact concentration of the hydrochloric acid solution. The titration you do will allow you to calculate this.

2. Pipette exactly 25.0 cm^3 sodium hydroxide solution into a clean conical flask (Fig. 1.1). The pipette can be cleaned in a similar way to the beakers, remembering to finish by washing it out with a little of the alkali solution twice to ensure no dilution will take place when using the pipette.

In this case it does not matter if there is some deionised water left in the flask after rinsing it. Now add one or two drops of acid-base indicator.

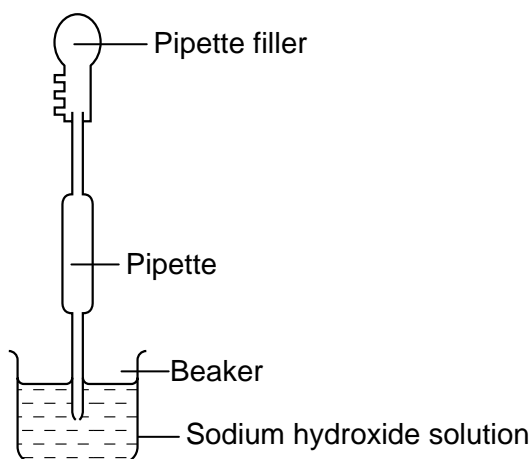

Figure 1.1 A pipette safety filler is used to draw a measured volume of sodium hydroxide solution from the beaker into the pipette.

3. Once the burette has been rinsed and washed out with the acid solution, fill it nearly to the top (Fig. 1.2).

Clamp the burette carefully and run a little acid through into the beaker until the tip becomes full.

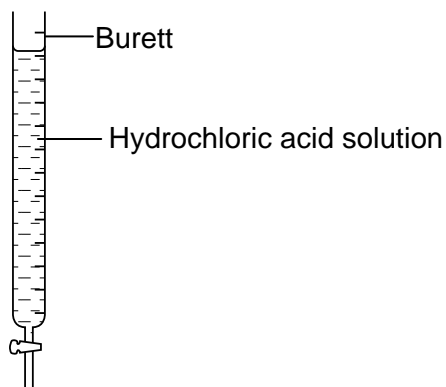

Figure 1.2 Fill the burette with hydrochloric acid solution and ensure the tip is full.

4. Now read the burette and record the reading in the middle row of a table like the one below. Be careful that your eye is level with the bottom of the meniscus or your reading will not be accurate (Fig. 1.3).

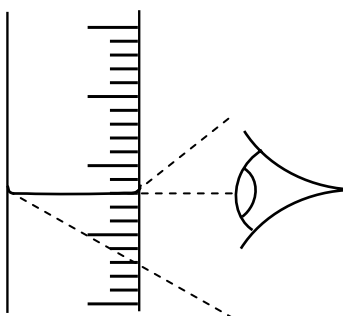

Figure 1.3

	<i>rough titration</i>	1	2
<i>final burette reading/cm³</i>			
<i>initial burette reading/cm³</i>			
<i>volume of acid added/cm³</i>			

5. Place the conical flask below the burette on a piece of white paper. Run the acid into the flask fairly quickly, shaking it all the time. As soon as the colour of the indicator changes, close the tap and note the final burette reading. Record this result in your table above your initial reading. Subtract the initial reading from the final reading to give you the volume of acid added.
6. The first titration is a rough titration to give you an idea of the volume you need to add to exactly neutralise the acid. It is quite likely that you added a slight excess of acid as you were doing the titration quickly. Now repeat steps 2 to 5 but this time run in the acid quickly until you reach about 1 cm³ less than the volume you added in the rough titration. Swirl the contents of the flask and add one drop of acid at a time from the burette until the indicator just changes colour. Record this volume. This should represent the exact volume you need to add to neutralise 25 cm³ of 0.1 mol dm³ of sodium hydroxide solution.
7. To ensure that you have a reliable volume of alkali, you should repeat the whole titration again until you get two readings that agree within 0.05 cm³.
8. Now you are sure of the volume of sodium hydroxide you require, repeat the titration without using the indicator. This should give you a pure sodium chloride solution, without any excess acid or alkali.
9. Evaporate all the water away from a small sample of your neutral solution using the apparatus in Fig. 1.4. Be sure to adjust your Bunsen burner to give a suitable flame. You will be left with small, white crystals of sodium chloride.

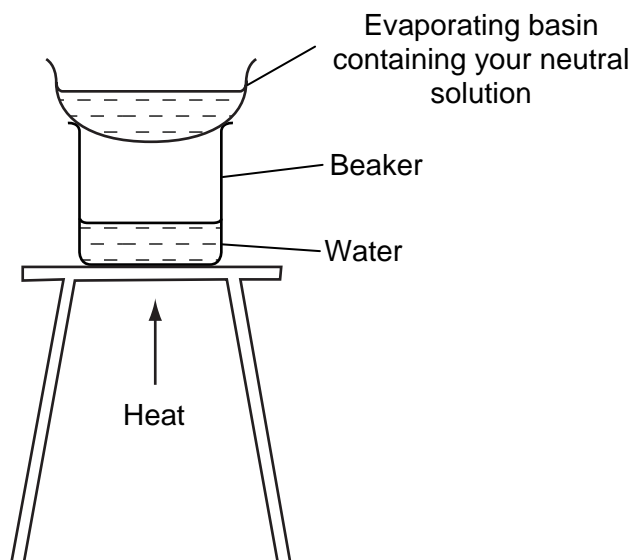

Figure 1.4

Questions

- 2 (a) How many moles of NaOH were present in 25.0 cm^3 solution?
- (b) How many moles of HCl were present in the volume of acid you used to neutralise the NaOH solution? To calculate this you will need to refer to the equations you wrote in Question 1.
- (c) What was the exact concentration of the hydrochloric acid in mol dm^{-3} ?
- (d) How many moles of sodium chloride were produced in the solution in the conical flask?
- (e) What mass of salt was produced in the neutral solution?
- 3 Look back at the experimental procedure.
- (a) Why was the conical flask placed on a piece of white paper?
- (b) Why were the pipette and the burette washed with the solutions they were going to contain?
- (c) Why was the conical flask not washed with the alkali solution it was going to contain?
- (d) Explain why it does not matter if there is water already in the flask.
- (e) Explain why a conical flask was used and not a beaker.

1. Making salt – an introduction to some basic techniques – Teachers' Notes

This practical focuses on revising some basic techniques, such as the correct use of the Bunsen burner when heating. It gives students the opportunity to set up and manipulate apparatus and provides an introduction to a simple titration. Students will also record their results in a table.

Learning outcomes

These are printed on the Student Sheet.

A suggested approach

If students have not used a burette or pipette before, it would be sensible to spend a few minutes demonstrating the techniques involved in titration.

The Student Sheet gives full information about how to do the practical. Students could prepare for the practical session by reading the sheet in advance and answering Question 1. The students should finish the titration in a 1-hour session. The neutral sodium chloride solutions should be kept if you intend to evaporate off the water. It is motivating and fun for students to actually see the product that they have made and the second lesson could also be used to go through the mole calculations. It is also important to remind students about the correct use of the Bunsen burner.

Technical information

Requirements per student/group:

For the titration

Two 100 cm³ beakers

25.0 cm³ pipette

Pipette filler or equivalent safety device

50.0 cm³ burette

Conical flask

Sheet of white paper or a white tile

Wash bottle and deionised water

0.10 mol dm⁻³ NaOH(aq) – about 80 cm³ (**corrosive**)

Approximately 0.1 mol dm⁻³ HCl(aq) – about 80 cm³ (**irritant**)

Stoppered flask to store a sample of the neutral solution prepared

For the evaporation of the neutral solution

Evaporating basin

250 cm³ beaker

Tripod and gauze

Heating mat

Bunsen burner

Safety

The main points are included on the Student Sheet but it is the teacher's responsibility to ensure that a full risk assessment is carried out prior to the practical session(s). MSDS sheets should be consulted so that the correct action can be taken in event of a spillage and/or accident.

Answers to questions on the Student Sheet

- 1 (a) sodium hydroxide + hydrochloric acid → sodium chloride + water
 $\text{NaOH(aq)} + \text{HCl(aq)} \rightarrow \text{NaCl(aq)} + \text{H}_2\text{O(l)}$
- (b) $\text{Na}^+(\text{aq}) + \text{OH}^-(\text{aq}) + \text{H}^+(\text{aq}) + \text{Cl}^-(\text{aq}) \rightarrow \text{Na}^+(\text{aq}) + \text{Cl}^- + \text{H}_2\text{O(l)}$
- (c) $\text{H}^+(\text{aq}) + \text{OH}^-(\text{aq}) \rightarrow \text{H}_2\text{O(l)}$
- (d) Alkalis.
- 2 (a) Moles of NaOH in 25cm^3 $0.1 \text{ mol dm}^{-3} = 0.1 \times 25/1000 = 2.5 \times 10^{-3} \text{ mol}$
- (b) This will be the same as **2(a)** above.
- (c) This is dependent on the volume of HCl used but it will be approximately 0.1 mol dm^{-3} .
- (d) This will be the same numerical answer as in **2(a)** and **2(b)**.
- (e) The moles given in **2(d)** are multiplied by $M_r \text{ NaCl}$ (58.5).
- 3 (a) To see the end point more clearly.
- (b) To ensure there was no dilution when they were filled with the solutions to be titrated.
- (c) So that no extra moles of NaOH were present in the flask.
- (d) The amount of water present does not affect the moles of NaOH that were pipetted into the flask.
- (e) The sloping sides prevent splashes, which would lose moles of the acid or alkali and make the titration inaccurate.

3. How much iron is there in an iron tablet? – Student Sheet

In this practical you will have the opportunity to perform a quantitative analysis using the technique of titration. You are going to analyse an iron tablet to find out how much iron is actually present in it.

Titration involving potassium manganate(VII) may form part of your Practical Assessment.

Intended lesson outcomes

By the end of this practical you should be able to:

- perform a titration involving potassium manganate(VII);
- read a burette and use a pipette;
- use a volumetric flask;
- record your titration results appropriately in tables you have drawn yourself;
- use and understand an ionic equation;
- use the mole concept to perform calculations.

Background information

Iron performs a vital role in our bodies. It is present in red blood cells and forms part of the haemoglobin molecule, which combines with oxygen from the lungs. The oxygen is then transported all round the body. When young people are growing rapidly, the body may not have enough iron and this causes anaemia. This can be remedied by a course of 'ferrous sulphate' tablets, often known as iron tablets.

The iron in iron tablets is in the form of hydrated iron(II) sulphate (sometimes called ferrous sulphate). As the name iron(II) suggests, the Fe^{2+} ion is present. To determine just how much Fe^{2+} is in each tablet, we can react the Fe^{2+} ions with manganate(VII) ions, which have a formula MnO_4^- .

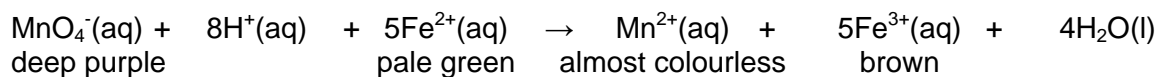



Although this ionic equation may appear complicated at this point in your course, you can see from the colours that the deep purple of the $\text{MnO}_4^-(\text{aq})$ will disappear when the reaction is complete.

The end point is when the addition of one extra drop of potassium manganate(VII) solution turns the solution in the conical flask to a pale pink colour.

Question

- 1 Explain why this volumetric analysis does not require an indicator.

Safety

	You must wear eye protection throughout this experiment.
	1.0 mol dm ⁻³ sulphuric acid is irritant . Wash all spillages with plenty of water.

Always use a pipette filler, or other suitable safety device. Never be tempted to use your mouth to draw liquid into the pipette.

Procedure

1. Accurately weigh **two** iron tablets and record their mass.
2. Grind up the tablets with about 5 cm³ of 1.0 mol dm⁻³ sulphuric acid, using a pestle and mortar. Transfer this into a 100 cm³ volumetric flask. Use further small volumes of the dilute sulphuric acid to rinse the ground-up tablets into the flask, until no traces of the iron tablets are left in the mortar.
3. Add more 1.0 mol dm⁻³ sulphuric acid to make the volume in the volumetric flask exactly 100.0 cm³. Stopper the flask and shake it thoroughly to mix the solution. Not all of the outer coating of the tablets will dissolve. This does not matter as it does not contain any Fe²⁺ ions.
4. Use a pipette and pipette filler to withdraw 10.0 cm³ of the tablet solution and transfer it into a clean conical flask.
5. Wash a 100 cm³ beaker with deionised water and then twice with small volumes of the 0.0050 mol dm⁻³ potassium manganate(VII) solution you are going to use. Now half fill the beaker with the potassium manganate(VII) solution and use this to fill the burette. Remember that the burette does not have to be filled to the 0.00 cm³ mark. Make sure that you run some of the solution back into the beaker to ensure that the tip of the burette is full. Read the volume of potassium manganate (VII) solution in the burette. In this case the colour of the potassium manganate(VII) solution is so intense that you cannot see the bottom of the meniscus so you must use the top of the meniscus to measure the volume.
6. Draw up a table in which you can record your titration results. Label the rows and columns, using the appropriate units. Think about which value you will need to subtract from which when deciding on the order of your rows.
7. Perform one rough titration, followed by two accurate titrations that agree within 0.05 cm³ and record the results in your table.

Questions

- 2 (a) How many moles of MnO₄⁻(aq) were added from the burette?
 (b) How many moles of Fe²⁺(aq) were present in 10.0 cm³ of the iron tablet solution?
 (c) How many moles of Fe²⁺(aq) were present in 100.0 cm³ of the tablet solution?
 (d) What is the mass of iron in the two tablets?
 (e) Find out the mass of iron that the manufacturer states is in one tablet. How does your result compare?
 Suggest why there are differences.
- (f) If you were to repeat this experiment, how would you make sure that your result was as accurate as possible?
- 3 The reaction you have performed can be written as two half equations.
 - (a) Use only the ion symbols for iron(II) and iron(III) to write a half equation showing the oxidation reaction. Use e⁻ for the electron that is lost.
 - (b) The other half equation is the reaction of the manganate(VII) ion. What type of reaction will this be?
- 4 In air, an aqueous solution of iron(II) ions will oxidise easily to iron(III) ions. The addition of dilute sulphuric acid prevents this. However, there is another reason for adding dilute sulphuric acid. What is the other reason?

3. How much iron is there in an iron tablet? – Teachers' Notes

If you have used Practicals 1 and 2 in Appendix 1 of this booklet, students should have developed good techniques in titration. This volumetric analysis introduces the potassium manganate(VII) titration. In the practical scheme in Appendix 1 this is placed very early in the course and is intended to cover mole calculations and further develop skills that will be tested in the practical examination. It is not, at this stage, appropriate to spend time on a detailed explanation of the redox reaction as this comes up in the A2 part of the course. However, Question 3 on the Student Sheet should be accessible to students with the knowledge they have gained from their pre-A level course.

Learning outcomes

These are printed on the Student Sheet.

A suggested approach

Set the scene by explaining the context. Iron deficiency, or anaemia, affects many people and particularly the young. 'Ferrous sulphate' tablets, often just called iron tablets, rectify this deficiency. Iron deficiency may be the result of not eating enough foods containing iron and a change in diet to include more iron-rich food is often recommended to patients.

When drug companies manufacture iron tablets they put a set amount of iron into each tablet. This is usually written on the packet. One way a drug company can check the iron content of its tablet is to analyse it using this titration.

The Student Sheet gives full information about how to do the practical. Students could prepare for the practical session by reading the sheet in advance and answering Question 1.

The students should finish the titration in a 1-hour session.

Technical information

Requirements per student/group:

100 cm³ beaker
 100.0 cm³ volumetric flask
 Filter funnel
 10.0 cm³ pipette
 Pipette filler
 50.0 cm³ burette
 100 cm³ conical flask
 Pestle and mortar
 Sheet of white paper or a white tile
 Wash bottle and deionised water
 0.0050 mol dm⁻³ KMnO₄(aq) – about 100 cm³ * See notes 2 and 3 below
 Approximately 1 mol dm⁻³ H₂SO₄(aq) – about 120 cm³
 Two 'ferrous sulphate' tablets
 Access to the packet showing the mass of iron in each tablet
 Access to a balance weighing to 0.01 g

Notes

1. If brown or red colours are seen during the titrations, this will produce inaccurate results. The remedy is to add more dilute sulphuric acid.
2. The packet of iron tablets often describes the iron tablets as '200 mg tablets'.

3. If two '200 mg tablets' are used, then the expected volume of $0.0050 \text{ mol dm}^{-3}$ $\text{KMnO}_4(\text{aq})$ will be 28.60 cm^3 per titration. If the mass of iron is 200 mg, then the volume will be 14.30 cm^3 .

Safety

The main points are included on the Student Sheet but it is the teacher's responsibility to ensure that a full risk assessment is carried out prior to the practical session(s). MSDS sheets should be consulted so that the correct action can be taken in event of a spillage and/or accident.

Answers to questions on the Student Sheet

- 1 The reaction is self-indicating. The end point of the titration is shown when one extra drop of $\text{KMnO}_4(\text{aq})$ does not go colourless but turns the reacting solution a pale pink colour.
- 2 (a) Moles of MnO_4^- depend on the volume of solution run in from the burette.
 Moles $\text{MnO}_4^- = \text{concentration } \text{MnO}_4^-(\text{aq}) \text{ (i.e. } 0.0050 \text{ mol dm}^{-3}) \times \text{volume delivered from burette}/1000$
- (b) Moles of $\text{Fe}^{2+}(\text{aq})$ in $10.0 \text{ cm}^3 = 5x$ the answer given in **1(a)**.
- (c) Since a 100 cm^3 solution was made up from the two tablets: moles $\text{Fe}^{2+}(\text{aq}) = 10x$ answer in **(b)**.
- (d) The moles given in **2(c)** are multiplied by $A_r \text{ Fe}$ (56).
- (e) Look for an appreciation of the limitations of the experiment. The reading of the burette is not likely to be the most significant error, as the scale can be read to $\pm 0.05 \text{ cm}^3$. However, it may be that some of the Fe^{2+} was oxidised by the air. Perhaps the crushing operation did not allow all of the contents of the tablet to dissolve. Look for sensible evaluations of technique.
- (f) This may depend on what is said in **(e)** but also look for sensible comments about using more tablets in case there is a variation of mass between tablets, or to make the weighing more accurate. Students may suggest that a balance that reads to 0.001 g should be used. As the usual mass of iron in a tablet is 200 mg, this is a sensible suggestion.
- 3 (a) $\text{Fe}^{2+}(\text{aq}) \rightarrow \text{Fe}^{3+}(\text{aq}) + \text{e}^-$
 (b) Reduction.
- 4 $\text{H}^+(\text{aq})$ is an essential reactant as it appears in the reaction equation.

5. What is the volume of 1 mole of hydrogen gas? – Student Sheet

One mole of any gas occupies the same volume when measured under the same conditions of temperature and pressure. In this experiment you will calculate the volume of 1 mole of hydrogen at room temperature and pressure.

Intended lesson outcomes

By the end of this practical you should be able to:

- further develop skills in manipulating apparatus and accurate measurement;
- use the mole concept;
- calculate the molar volume at room temperature and pressure.

Background information



Magnesium reacts with acid to give a salt and water.

Question

- 1 Write the word and balanced equation for the reaction of magnesium with dilute hydrochloric acid.

If the mass of magnesium is measured, then the moles of magnesium can be calculated. Once this amount is known, you can use the equation you have written in Question 1 to calculate the moles of hydrogen that are produced. If the volume of this amount of hydrogen is measured, then you can calculate the volume of 1 mole, also known as the **molar volume**.

Safety

	You must wear eye protection throughout this experiment.
	Hydrochloric acid is corrosive . (Although the solution is very dilute, you should mop up any spillages and rinse any solution off your skin or clothing with water).
	Magnesium ribbon is highly flammable

Procedure

1. Clean a piece of magnesium ribbon about 3.5 cm long then weigh it accurately. This should weigh between 0.02 g and 0.04 g; if not, adjust the length of magnesium until it does.
2. Place about 30 cm³ 1M hydrochloric acid in the burette and top this up to 50 cm³ with water.
3. Push the magnesium into the top of the burette, above the liquid level, so that it is held by its own tension (see Fig. 5.1).
4. Add 50 cm³ of water to a crystallising dish.
5. Quickly invert the burette into the water. Provided you do this quickly and carefully, you will lose very little of the liquid in the burette. The liquid level should be on the graduated scale. If it is not, open the tap for a moment to allow the level to drop. Record the burette reading.

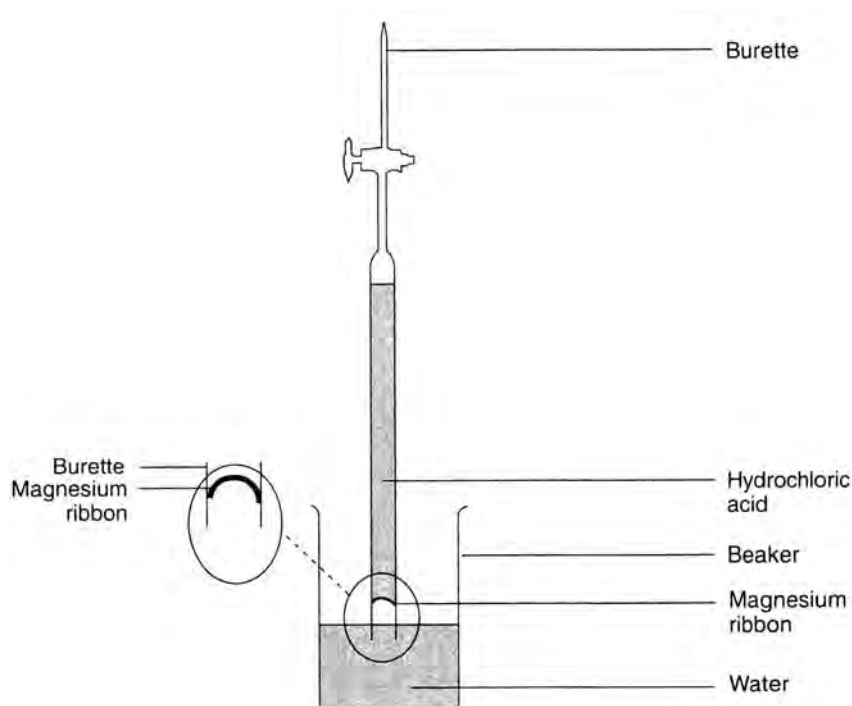

Figure 5.1

6. Clamp the burette and record the volume. Remember that the scale is now upside down.
7. Soon the acid will diffuse down to the magnesium and it will begin to react. When the magnesium has all reacted, note the new volume and calculate the volume of hydrogen produced.
8. Record the temperature of the laboratory.

Questions

- 2 (a) How many moles of magnesium did you use?
- (b) How many moles of hydrogen are produced? To calculate this you will need to refer to the equation you wrote in Question 1.
- (c) What is the volume of 1 mole of hydrogen gas at the temperature and pressure of the laboratory?
- 3 The general gas equation is $pV = nRT$, where p is the pressure, T is the temperature and R is the ideal gas constant. This can be used to calculate the volume of gas as standard temperature and pressure (s.t.p.). Since n , R and p stay the same, the equation for calculating this is

$$\frac{V_1}{T_1} = \frac{V_2}{T_2}$$

Calculate the molar volume at s.t.p.

5. What is the volume of 1 mole of hydrogen gas? – Teachers' Notes

In this practical students react magnesium quantitatively with hydrochloric acid. They collect the hydrogen gas and calculate the molar volume.

Learning outcomes

These are printed on the Student Sheet.

A suggested approach

Begin by explaining to students that the molar volume of any gas is always the same at the same temperature and pressure. In this experiment they are going to calculate this volume under room conditions. Inverting the burette safely and with little loss of liquid is not difficult but you will need to demonstrate the procedure before they start. Bring the lip of the crystallising dish up to the top of the burette and rest it there. Now swing the tap end round and upright. If the liquid level is not on the scale, open the tap momentarily to allow the liquid level to drop down to the scale. The actual practical should take approximately 30 minutes. There will then be time for students to do the calculations. Question 3 uses the general equation. If this has not been covered in theory, you may wish to give a very brief explanation, while saving a more rigorous explanation until later. The main point is that the volume of a gas varies in direct proportion to the temperature.

Technical information

Requirements per student/group:

Crystallising dish

50.0 cm³ burette

Clamp stand

1 mol dm⁻³ hydrochloric acid

0.02 g – 0.04 g standard magnesium ribbon (this is about 3.5 cm)

Thermometer

Safety

The main points are included on the Student Sheet but it is the teacher's responsibility to ensure that a full risk assessment is carried out prior to the practical session. MSDS sheets should be consulted so that the correct action can be taken in event of a spillage and/or accident.

Answers to questions on the Student Sheet

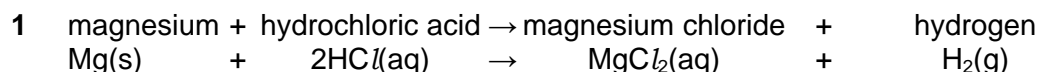

2 (a) Moles of Mg used = mass of Mg/ $A_r(\text{Mg})$

It should be between 8.33×10^{-4} mol and 1.67×10^{-3} mol.

(b) This depends on the moles of Mg used. It will be the same value as calculated in (a).

(c) This will depend on the temperature and pressure of the room but students can expect an answer of approximately 24 dm³.

3 The volume at s.t.p. (0°C) will be approximately 22.4 dm³.

8. Measuring the enthalpy changes of exothermic and endothermic reactions – Student Sheet

Chemical reactions are often accompanied by energy changes. These experiments show you how energy changes can be measured.

Intended lesson outcomes

By the end of this practical you should:

- have further developed skills in manipulating apparatus and accurate measurement of temperature;
- know that some chemical reactions are accompanied by energy changes in the form of heat energy;
- know that energy changes can be exothermic (ΔH , negative) or endothermic (ΔH , positive);
- be able to calculate enthalpy changes from your experimental results using enthalpy change = $mc\Delta T$.

Background information

To make a chemical bond, another bond must first be broken. It is the sum of the energy changes in making and breaking bonds that results in the overall energy change in a reaction. **Enthalpy** is the stored energy in a compound. It has a symbol **H**. If some of this stored energy is released during a reaction, the surroundings heat up. This is an exothermic reaction and we say that the change of enthalpy, ΔH , is negative. (Δ means *change of*.) However, if energy is absorbed during a reaction, then ΔH is positive and the surroundings cool down.

To measure enthalpy changes you are going to use a polystyrene cup as a calorimeter (Fig. 8.1). A calorimeter is any container that is used to measure energy changes from chemical reactions.

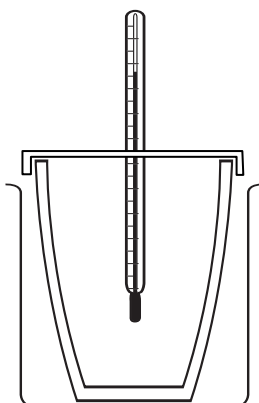





Figure 8.1

Question

- 1 The simple apparatus in Fig. 8.1 is very effective in minimising energy losses and this is important if we are going to measure accurately any energy changes arising from reactions.

Explain three ways in which heat energy loss is minimised using this apparatus.

Safety

	You must wear eye protection throughout this experiment.
 	Copper sulphate is harmful and dangerous for the environment
	Zinc powder is highly flammable .

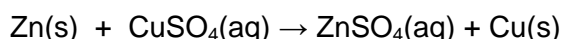
Procedure**Experiment 1: The displacement reaction between zinc and copper(II) sulphate**

Use a measuring cylinder to pour 50 cm³ of 0.2 mol dm⁻³ copper(II) sulphate into the polystyrene cup. Weigh out about 1 g of powdered zinc onto a piece of paper. This is an excess (more than is needed to react with the copper(II) sulphate) so it does not need to be measured accurately. Record the initial temperature of the solution in the cup and then add the powdered zinc. Stir the solution gently and constantly with the thermometer until the temperature stops changing. Record the final temperature reached. Rinse the cup with water ready for use in Experiment 2.

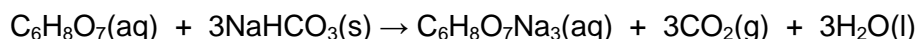
Experiment 2: The reaction between citric acid and sodium hydrogen carbonate

Use the same procedure as in Experiment 1 but this time use 25 cm³ of 1 mol dm⁻³ citric acid and weigh out 8 g sodium hydrogen carbonate. This reaction froths up, so add the powdered solid slowly enough to prevent it coming over the top of the cup. Keep stirring and record the maximum temperature change.

Processing your results

We assume that all the energy in these reactions is exchanged with the surrounding water and no energy is transferred to the air, the glass of the thermometer, or the polystyrene cup. We know that the specific heat capacity of water, *c*, is approximately 4.2 J g⁻¹ K⁻¹. This means that 4.2 J of energy will raise the temperature of 1 g of water by 1 K. (This is the same as 1°C.) As the solution is dilute, we also assume it has the same specific heat capacity of water and the same mass. 1 cm³ of water weighs 1 g.

We are going to use the relationship:

$$\begin{aligned} \text{enthalpy change} &= \text{mass} \times \text{specific heat capacity of the solution} \times \text{temperature change} \\ \text{enthalpy change} &= mc\Delta T \end{aligned}$$

For each experiment, calculate the enthalpy change that took place.

To complete the calculations, chemists express their results as enthalpy changes per mole of equation. In the first reaction, 1 mole of copper(II) sulphate appears in the balanced equation; in the second reaction there is 1 mole of citric acid.

Work out the enthalpy change per mole and indicate whether it is exothermic or endothermic by using '+' or '-' next to your enthalpy values.

Questions

- 2** **(a)** In Experiment 1, zinc was in excess. Calculate the moles of copper(II) sulphate used and the moles of zinc used. Now use the reacting moles in the balanced equation to show that zinc is indeed the reactant that is in excess.
(b) Similarly, show that sodium hydrogen carbonate is the reagent in excess.
- 3** Write the ionic equations for the reactions in Experiments 1 and 2. Do not include any spectator ions.

8. Measuring the enthalpy changes of exothermic and endothermic reactions – Teachers' Notes

In these two experiments students have the opportunity to accurately measure a temperature change and calculate the enthalpy changes of the reactions.

Learning outcomes

These are printed on the Student Sheet.

A suggested approach

Students will already have some familiarity with exothermic and endothermic reactions but it will probably be worth reminding them about this before they start. The concept of bond breaking and bond making and how this contributes to the overall enthalpy change is mentioned in the 'Background information' section on the Student Sheet, as is the requirement to minimise heat losses. Under the 'Procedure', the concept of having one reactant in excess is described but the reason is explored in Question 2.

The practical will take about 40 minutes, leaving time for the 'Processing your results' section to be tackled. Students could finish off calculations and answer the questions for homework.

Technical information

Requirements per student/group:

Polystyrene cup with lid

Glass beaker large enough to stand the polystyrene cup in but not much larger (see Fig. 8.1 on the Student Sheet)

Thermometer, -5°C to 50°C

50 cm^3 and 25 cm^3 measuring cylinders

1 mol dm^{-3} citric acid, approximately 30 cm^3

0.2 mol dm^{-3} copper(II) sulphate, approximately 60 cm^3 (**harmful**)

1 g zinc powder (**highly flammable**)

8 g sodium hydrogen carbonate

Access to a balance weighing 0.01 g

Safety

The main points are included on the Student Sheet but it is the teacher's responsibility to ensure that a full risk assessment is carried out prior to the practical session. MSDS sheets should be consulted so that the correct action can be taken in event of a spillage and/or accident.

Processing the results

Although this is described in the Student Sheet, students may need help in understanding the calculation per mole of reaction. The approximate values are given below.

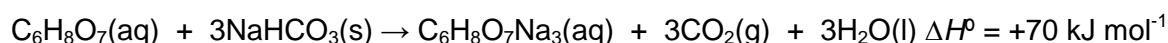
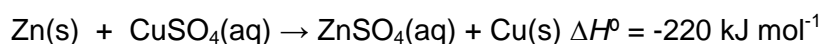

Answers to questions on the Student Sheet

- Polystyrene is a good insulator, so heat loss from the sides is minimised. The lid prevents energy loss from the top and the glass beaker provides another layer of insulation for the sides, as the air trapped in the beaker is also a poor conductor.
- (a) If 1 g of powdered zinc is used, then moles of $\text{Zn} = 1/65 = 0.015\text{ mol}$.

Appendix 2

The moles of CuSO_4 in solution = $0.2 \times 50/1000 = 0.01$ mol.

Since the equation involves 1 mole of CuSO_4 reacting with 1 mole of Zn, the zinc is in excess.

(b) If 8 g of sodium hydrogen carbonate is used, moles $\text{NaHCO}_3 = 8/84 = 0.095$ mol.

Moles of citric acid = $1 \times 25/1000 = 0.025$ mol.

From the equation, 3 moles of NaHCO_3 exactly react with 1 mole citric acid. $3 \times 0.025 = 0.075$ mol. This is 0.02 mol less than the actual moles added, so NaHCO_3 is in excess.

(c) To ensure complete reaction:

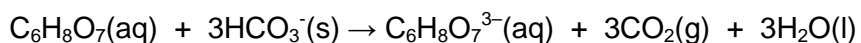
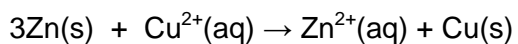

12. The effect of altering the concentration on an equilibrium reaction – Student Sheet

Your teacher has introduced you to Le Chatelier's Principle. You are now going to use this principle to predict the effect of changing the concentrations of the reactants on the equilibrium position.

Background information

Le Chatelier's Principle applies to systems in dynamic equilibrium. One way of stating this is:

The position of the equilibrium of a system changes to minimise the effect of any imposed change in conditions.

Question

1 What conditions, other than concentration, could affect the position of equilibrium?

Your teacher is going to demonstrate the effects of changing the concentration of substances in this dynamic equilibrium mixture:

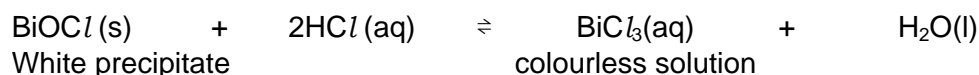

Question

2 Explain what is meant by the terms 'reversible reaction' and 'dynamic equilibrium'.

Your teacher will prepare a solution of bismuth trichloride from bismuth oxide chloride.

Question

3 How might your teacher prepare bismuth trichloride?

Your teacher will add water to the above equilibrium mixture.

Questions

- 4 (a) Predict what you will observe when water is added.
(b) Use Le Chatelier's Principle to explain your prediction.

Following the addition of water, your teacher will add concentrated hydrochloric acid to the equilibrium mixture.

Questions

- 5 What safety precautions should your teacher adopt?
6 (a) Predict what you will observe when concentrated hydrochloric acid is added.
(b) Use Le Chatelier's Principle to explain your prediction.

12. Introducing equilibria through two demonstrations – Teachers' Notes

This is an effective way of introducing the syllabus section on equilibria. It shows a reversible reaction and allows a dynamic equilibrium to be reached. The system at equilibrium is then subjected to changes in concentration and temperature, thus demonstrating Le Chatelier's Principle. The Student Sheet is intended to accompany the second demonstration.

Learning outcomes

By the end of this lesson students should:

- understand what is meant by a reversible reaction and a dynamic equilibrium;
- have been introduced to Le Chatelier's Principle;
- have observed the effects of changes of concentration and pressure on the equilibrium position.

A suggested approach

Begin the lesson with Demonstration 1. Use this to cover the intended learning outcomes. With discussion of the underlying theory, this could easily take 25 minutes. Now give out the Student Sheet, 'The effect of altering the concentration on an equilibrium reaction', and ask students to use it to predict what will happen in Demonstration 2. Test their predictions by doing the second demonstration.

Demonstration 1: The equilibrium between $\text{Co}(\text{H}_2\text{O})_6^{2+}(\text{aq})$ and $\text{CoCl}_4^{2-}(\text{aq})$

Theory

The equilibrium is:

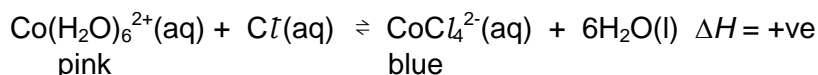



This experiment allows you to demonstrate the effect of concentration and temperature on the equilibrium position of this reaction. The changes seen are in accordance with Le Chatelier's Principle.

Technical information

Six boiling tubes and a rack
 100 cm³ measuring cylinder
 Three 250 cm³ beakers
 Two dropping pipettes
 Access to a balance
 4 g cobalt chloride-6-water ($\text{CoCl}_2 \cdot 6\text{H}_2\text{O}$)
 100 cm³ of concentrated hydrochloric acid
 200 cm³ of crushed ice

Safety

	You must wear eye protection throughout this experiment.
	Hydrochloric acid is corrosive . (It has a highly exothermic reaction with water, so always add the concentrated acid to the aqueous solution, never do it the other way round).

It is the teacher's responsibility to ensure that a full risk assessment is carried out prior to the demonstration.

this slowly into another boiling tube containing about 12 cm³ water. (Never do this the other way round!) A white precipitate of bismuth oxide chloride immediately appears. Transfer the mixture into a 100 cm³ beaker and add another 2 cm³ of concentrated hydrochloric acid and stir. The precipitate re-dissolves. Now add 25 cm³ of water and the precipitate re-appears. Adding 3 cm³ of concentrated hydrochloric acid will again shift the equilibrium to the colourless side. You can continue doing this by transferring the mixture to a 250 cm³ beaker.

Answers to questions on the Student Sheet

- 1 Temperature and pressure.
- 2 Reversible reactions take place in either direction.
Dynamic equilibrium is one where the rate of the forward reaction is equal to the rate of the reverse reaction.
- 3 By adding hydrochloric acid to bismuth oxide chloride.
- 4 (a) A white precipitate will form.
(b) Water appears on the right-hand side of the equilibrium equation. Adding more water is an imposed change of condition. By Le Chatelier's Principle, the equilibrium will shift to the left to minimise the effect of the added water.
- 5 Expect 'Wear safety goggles'. You might wish to point out that the risk to the eyes really started at the beginning of the demonstration. You should also add that concentrated acids often have a highly exothermic reaction if water (or a dilute solution) is added to them. Concentrated acids should always be added slowly to the water and never the other way around.
- 6 (a) The white precipitate dissolves to leave a colourless solution.
(b) Hydrochloric acid appears on the left-hand side of the equilibrium equation. The changed condition that is imposed is that the concentration of hydrochloric acid increases in the equilibrium mixture. This imposed condition is minimised by the equilibrium shifting to the right-hand side.

13. Determining the value of K_c for an equilibrium reaction – Student Sheet

In this experiment you have the opportunity to use the skills you have developed by doing volumetric analysis to determine an equilibrium constant.

Intended lesson outcomes

By the end of this practical you should:

- be able to deduce an expression for the equilibrium constant, K_c ;
- be able to calculate a value for K_c from the concentrations of substances at equilibrium;
- be able to draw up a table for the results of your calculations;
- have further developed your skills in titration techniques;
- be aware of the use of a **control** in an experiment.

Background information

Ethyl ethanoate is an important solvent. One way of manufacturing it is shown by the following equation.

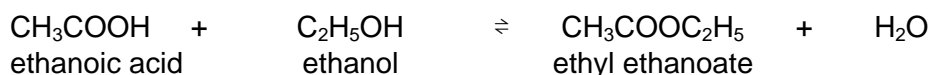



This is the equilibrium you are going to investigate. It takes a very long time for this reversible reaction to reach equilibrium. An acid catalyst, such as hydrochloric acid is used to speed up both the forward and reverse reactions. This enables the equilibrium to be reached in a much shorter time. The catalyst does not affect the value of K_c .

Question

- 1 What is the expression for K_c for this equilibrium?

Safety

	You must wear eye protection throughout this experiment.
	Glacial ethanoic acid is corrosive . (Mop up any spillages with plenty of water).
	Hydrochloric acid is corrosive .

Procedure

1. Your class is going to set up five boiling tubes with different starting concentrations of the various reactants. The volumes of each reactant you need to add are shown in the following table. Take great care with glacial ethanoic acid – it is pure ethanoic acid and is very corrosive.

boiling tube	volume of liquid/cm ³				
	HCl (1 mol dm ⁻³)	glacial ethanoic acid CH ₃ COOH	ethanol C ₂ H ₅ OH	ethyl ethanoate CH ₃ COOC ₂ H ₅	H ₂ O
A (control)	2	0	0	0	18
B	2	6	6	6	0
C	2	0	6	6	6
D	2	6	0	6	6
E	2	6	6	0	6

- Stopper the boiling tubes, label them and leave for a week, immersed in a bucket of water. This will keep the temperature reasonably constant and allow equilibrium to be achieved.
- After a week has passed, the reactions in tubes B, C and D need **quenching**. This prevents the position of equilibrium from changing any more. Adding water, which makes the reaction mixture very dilute, does this and stops the catalytic effect of the hydrochloric acid.

Take 10.0 cm³ from each boiling tube using a pipette and pipette filler. Make each up to 100.0 cm³ in a volumetric flask using deionised water. (Remember to wash the pipette with a little deionised water and then twice with a very small volume of the liquid in the boiling tube.)

Label these flasks B, C and D to correspond to the contents of the original boiling tubes.

- For tube A, pour the entire contents into a 100.0 cm³ volumetric flask and make up to the 100.0 cm³ mark. Wash the boiling tube twice with a little deionised water and transfer the washings. Label this flask A.
- From each volumetric flask except A, withdraw 10.0 cm³ using a clean pipette and pipette filler. Transfer the liquid to a conical flask and add two or three drops of phenolphthalein indicator. Titrate this with 0.01 mol dm⁻³ NaOH(aq). Do a rough titration followed by two accurate readings that agree within 0.1 cm³.
- Pour the entire contents of volumetric flask A, the solution made up from tube A, into a 250 cm³ conical flask. Rinse the volumetric flask twice with a little deionised water and transfer the washings to the conical flask. Add phenolphthalein indicator. In this case you are not going to be able to do a rough titration, so add 0.5 cm³ at a time until the indicator changes colour.

Processing your results

Although this looks complicated, if you take it by stages it should be straightforward.

Stage 1

You need to know how many moles of each reactant you started with. You can calculate this if you know the density of each liquid as mass = volume x density.

	CH ₃ COOH	C ₂ H ₅ OH	CH ₃ COOC ₂ H ₅	H ₂ O
density/ g cm ⁻³	1.05	0.79	0.92	1.0

Worked example – tube B, ethanoic acid:

If 6.0 cm³ of ethanoic acid is added, the mass of CH₃COOH = 6.0 cm³ x 1.05 g cm⁻³ = 6.3 g
M_r CH₃COOH = 60, therefore mol CH₃COOH = 6.3/60 = 0.105 mol

Now draw up a table to record the starting moles for the four liquids for each of the boiling tubes C, D and E and record the results of your calculations.

Stage 2

Calculate the number of moles of HCl in 2.0 cm^3 1 mol dm^{-3} HCl. In this case you do not need to use density, as we already know its concentration.

For the contents of tube A, all these moles were titrated against 0.1 mol dm^{-3} NaOH. Calculate the volume of NaOH you would expect to add to neutralise the hydrochloric acid present. This should be the actual volume you used because there was only water and HCl in the mixture. This is your control and it is used to prove that the concentration of HCl is not changed by the conditions of the experiment.

Stage 3

There are two neutralisation reactions arising in the titrations from volumetric flasks B, C and D. The end point is when both acids are neutralised.

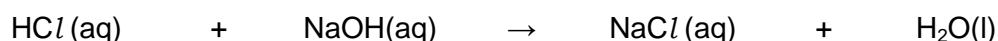
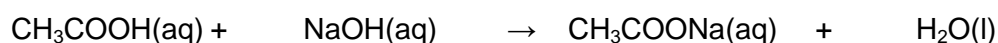

Remember, every neutralisation reaction can be expressed ionically as:

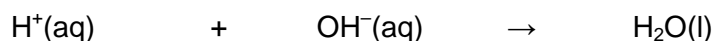

- For each titration result from flasks B, C, D and E, calculate the number of moles of $\text{H}^+(\text{aq})$ present.
- Before doing the titrations, you diluted the solutions in the boiling tubes. This was to quench the equilibrium mixtures. First of all you only pipetted half the 20.0 cm^3 of the equilibrium mixture from the boiling tube into the volumetric flask. Then you only transferred a tenth of these moles from the volumetric flask into the conical flask. The result of these two actions means that you must multiply each of your answers in (a) by 20 to give the number of moles $\text{H}^+(\text{aq})$ in each original equilibrium mixture.
- We know from Stage 2 that the moles of H^+ due to the catalyst HCl remained unchanged. Now subtract the number of moles of H^+ in each tube from your answer in (b). You now have the equilibrium moles of ethanoic acid. This amount may be greater or less than the number of moles you started with.

Stage 4

At this stage you can calculate the moles of each substance present at equilibrium. We will show how to do this using your results for tube B.

- Moles of ethanoic acid present at equilibrium = x mol** (this is the value from Stage 3)
These moles have not reacted because they were still in the boiling tube. You started with 0.105 moles of ethanoic acid. This means that $0.105 - x$ moles have reacted.
- Moles of ethanol at equilibrium = $0.103 - (0.105 - x)$**

The equation tells us that 1 mole of ethanoic acid reacts with 1 mole of ethanol. So $0.105 - x$ moles ethanoic acid must have reacted with $0.105 - x$ ethanol.

Look back at the table you drew up in Stage 1. For tube B you should have calculated a value of 0.103 for the starting moles of ethanol.

Therefore the number of moles of ethanol at equilibrium is the starting value 0.103 moles, minus the number of moles that have reacted, $0.105 - x$ moles, i.e. moles of ethanol at equilibrium = $0.103 - (0.105 - x)$

(c) Moles of ethyl ethanoate at equilibrium = 0.0627 + (0.105 – x)

We started with 0.0627 moles of ethyl ethanoate in tube B but because 0.105 – x moles ethanoic acid has reacted, 0.105 – x ethyl ethanoate must have been produced. The total ethyl ethanoate at equilibrium is the starting number of moles plus the number of moles produced.

(d) Moles of water at equilibrium = 0 + (0.105 + x)

This has increased by the same amount as ethyl ethanoate for the same reason. There was no water to start with in tube B.

In summary:

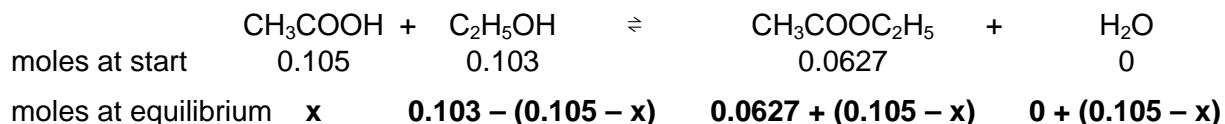
**Stage 5**

Using the number of moles of each substance at equilibrium in boiling tube B, we can calculate K_c .

The expression for K_c requires equilibrium *concentrations*. For the purposes of this calculation, all four substances are present in the same volume (20 cm³), therefore these volumes cancel each other out when substituted into the equilibrium expression. So we can use the number of moles. This is not always the case.

Using your answer to Question 1 in the 'Background information' at the start of this sheet, calculate K_c for tube B.

Work through the stages again to calculate values for K_c for boiling tubes C, D and E and tabulate your results for equilibrium moles and K_c for each tube.

13. Determining the value of K_c for an equilibrium reaction – Teachers' Notes

This experiment shows how an equilibrium constant can be measured using techniques students have already learned in their practical course to date.

Learning outcomes

These are printed on the Student Sheet.

A suggested approach

The Student Sheet gives full details of how to carry out the practical. Setting up the equilibrium mixtures can be done towards the end of a theory lesson about equilibrium constants. With careful preparation, it is safe and need not take too long. Before this lesson, fill burettes with each of the five liquids set out in Table 13.1 on the Student Sheet. This makes handling glacial ethanoic acid much safer for the students. Each student, or group of students, only needs to prepare one mixture, or two at the most. These are left in a bucket of water to try to keep the temperature reasonably constant. If you have access to a thermostatically controlled water bath, so much the better, but this is not essential.

After a week (although 3 days may well suffice), the boiling tube mixtures are at equilibrium, so the practical lesson is about titrating them to determine the equilibrium concentrations. It is only necessary for each group to titrate one of the boiling tube mixtures. As a suggestion, you could always tell students you have titrated tube A for them, since the concentration of hydrochloric acid remains the same in this *control* tube.

Technical information

Notes

1. We suggest that one student, or group, makes up one or two of the boiling tube mixtures.
2. The table on the Student Sheet gives the volumes for each boiling tube.

Requirements per student/group:

Setting up the mixtures

Bucket of water

Thermometer -5°C to 50°C for putting in the bucket of water

Boiling tubes with bungs

Access to burettes containing:

- deionised water
- glacial ethanoic acid (**corrosive**)
- ethanol
- ethyl ethanoate
- 1 mol dm^{-3} hydrochloric acid (**irritant**)

Titration of the equilibrium mixtures

10.0 cm^3 pipette

Pipette filler

0.01 mol dm^{-3} NaOH(aq)

Phenolphthalein

100 cm^3 conical flask

100 cm^3 volumetric flask

Sheet of white paper or a white tile

Wash bottle and deionised/distilled water

Safety

The main points are included on the Student Sheet but it is the teacher's responsibility to ensure that a full risk assessment is carried out prior to the practical session. MSDS sheets should be consulted so that the correct action can be taken in event of a spillage and/or accident.

You are strongly advised to set up the burette containing glacial ethanoic acid yourself.

Processing the results

Although the actual calculations look daunting, they are set out in a very logical way. However, students may still need help in understanding exactly what is happening at each stage. A sample calculation has been done in the case of boiling tube B. Students will be able to see the results of their calculations more clearly if they draw up suitable tables. These should have the appropriate row and column headings, including units. The K_c value expected is approximately 4.

The equilibrium concentrations of boiling tube mixtures C, D and E are as follows.

Boiling tube C

	CH_3COOH	+	$\text{C}_2\text{H}_5\text{OH}$	\rightleftharpoons	$\text{CH}_3\text{COOC}_2\text{H}_5$	+	H_2O
moles at start	0		0.103		0.0627		0.333
moles at equilibrium	x		$0.103 + x$		$0.0627 - x$		$0.333 - x$

Boiling tube D

	CH_3COOH	+	$\text{C}_2\text{H}_5\text{OH}$	\rightleftharpoons	$\text{CH}_3\text{COOC}_2\text{H}_5$	+	H_2O
moles at start	0.105		0		0.0627		0.333
moles at equilibrium	x		$(0.105 - x)$		$0.0627 + (0.105 - x)$		$0.333 + (0.105 - x)$

Boiling tube E

	CH_3COOH	+	$\text{C}_2\text{H}_5\text{OH}$	\rightleftharpoons	$\text{CH}_3\text{COOC}_2\text{H}_5$	+	H_2O
moles at start	0.105		0.103		0		0.333
moles at equilibrium	x		$0.103 - (0.105 - x)$		$(0.105 - x)$		$0.333 + (0.105 - x)$

Answer to question on the Student Sheet

$$1 \quad K_c = \frac{[\text{CH}_3\text{COOC}_2\text{H}_5][\text{H}_2\text{O}]}{[\text{CH}_3\text{COOH}][\text{C}_2\text{H}_5\text{OH}]}$$

15. The effect of temperature on reaction rate – Student Sheet

This experiment investigates the effect of temperature on the rate of reaction between sodium thiosulphate and dilute hydrochloric acid.

Intended lesson outcomes

By the end of this practical you should be able to:

- measure the effect of temperature on a reaction rate;
- represent your results graphically and draw conclusions;
- explain, in terms of the collision theory, why temperature change affects the reaction rate.

Background information



When sodium thiosulphate reacts with hydrochloric acid, a precipitate of sulphur forms. The time taken for a certain amount of sulphur to form is used to measure the reaction rate. The sodium thiosulphate solution can be heated to different temperatures before hydrochloric acid is added, so the effect of increasing temperature can be measured.

The effect of temperature increase on this reaction can be predicted using the collision theory. This theory says that for a reaction to occur, particles must collide with a certain minimum energy called the **activation energy**, E_A . When temperature is increased, particles have increased kinetic energy and move around faster. There is therefore an increase in the frequency of collisions.

Question

- 1 If sodium thiosulphate solution is heated, predict the effect of increasing the temperature on the rate of this reaction.

Safety

	You must wear eye protection throughout this experiment.
	Hydrochloric acid is corrosive .
	This reaction produces sulphur dioxide, which is toxic , so ensure good ventilation or use a fume cupboard. Take care not to inhale the fumes. Asthmatics need to be particularly careful.

Procedure

1. Measure 10 cm³ of sodium thiosulphate solution and 40 cm³ of water into a conical flask.
2. Measure 5 cm³ of dilute hydrochloric acid in a 10 cm³ measuring cylinder.
3. Warm the thiosulphate solution in the flask to the required temperature, as in Fig. 15.1.

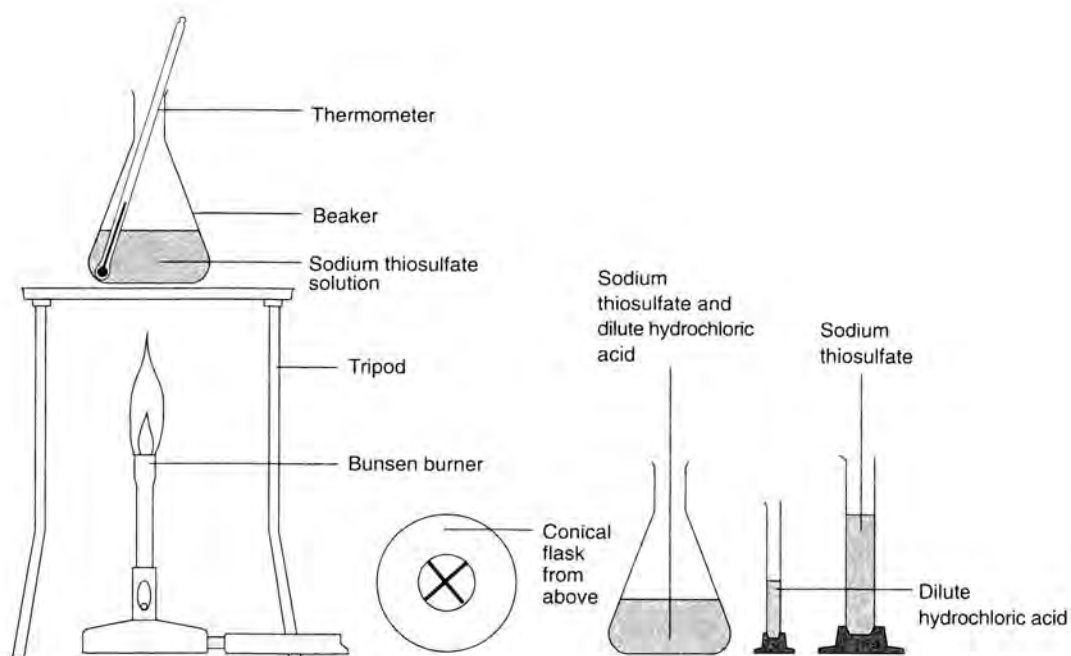
**Figure 15.1**

4. Put the conical flask over a piece of paper with a cross drawn on it.
5. Add the acid and start timing. Swirl the flask to mix the contents. Take the initial temperature of the mixture and record it in a table like the one below.
6. Repeat the experiment using different temperatures in the range 15°C to 65°C. Remember that one of your experiments can be carried out at room temperature and so will not require heating.

<i>initial temperature of the mixture in the flask/°C</i>	<i>final temperature of the mixture in the flask/°C</i>	<i>average temperature of the mixture in the flask/°C</i>	<i>time taken for the cross to disappear</i>	<i>1/time taken/s⁻¹</i>

7. Look down on the cross from above. When the cross disappears, stop timing and note the time taken. Record the final temperature of the mixture in the flask.
8. Immediately wash the solution down a sink with plenty of water.

Processing your results

For each set of results, calculate the average temperature and the value $1/\text{time}$. $1/\text{time}$ can be taken as a measure of the rate for this reaction.

Plot a graph of $1/\text{time}$ on the vertical (y) axis and average temperature on the horizontal (x) axis.

Question

2 What does the graph indicate about the effect of temperature on this chemical reaction?

15. The effect of temperature on reaction rate – Teachers' Notes

This experiment investigates the effect of temperature on the rate of the reaction between sodium thiosulphate and sulphur by using the time taken for the precipitate of sulphur that forms to blot out a cross drawn on a piece of paper.

Learning outcomes

These are printed on the Student Sheet.

A suggested approach

The effect of change of temperature on reaction rate is an everyday experience. Ask students to consider cooking ingredients to make a cake or the way that milk rapidly goes sour if it is not kept cold. When introducing this experiment, students will better understand the procedure if you demonstrate. The experiment can be used as an introduction to collision theory and there is a little about this in the 'Background information' on the Student Sheet. It can also lead to a discussion of the Boltzmann distribution.

The equation for the reaction is:

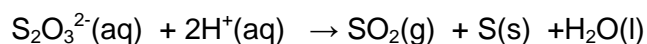

This is also a useful practical for emphasising graph-drawing skills such as choice of scale and line of best fit.

Technical information

Requirements per student/group:

Thermometer, -10°C to 110°C
 250 cm³ conical flask
 2 x 10 cm³ measuring cylinders
 25 cm³ or 50 cm³ measuring cylinder
 2 mol dm⁻³ hydrochloric acid, approximately 25 cm³ (**irritant**)
 40 g dm⁻³ sodium thiosulphate, approximately 50 cm³
 Bunsen burner, tripod, gauze and heatproof mat

Safety

The main points are included on the Student Sheet but it is the teacher's responsibility to ensure that a full risk assessment is carried out prior to the practical session. Sulphur dioxide, which is toxic, is produced in this reaction. A well-ventilated laboratory is essential. You should also warn asthmatics, as it is preferable for them to use a fume cupboard. If there is access to a fume cupboard with a sink, use this to wash away the reaction mixture with plenty of water as soon as the reaction is finished. This is particularly important with solutions at higher temperatures.

Processing the results

A curve showing that increase in temperature increases reaction rate, as measured by 1/time, should be obtained.

Answers to questions on the Student Sheet

- 1 Expect a prediction that increasing the temperature should increase the rate of reaction, since energy is increased so more particles would have the activation energy and there would be an increase in frequency of collision. A discussion of the Boltzmann distribution curve may be appropriate here.

- 2 Temperature increases the rate of reaction. It is not a directly proportional relationship. You may wish to inform students that, as a guide, for every 10°C rise in temperature, the rate doubles for reactions that work readily at room temperature.

21. Some redox reactions of halogens and halides – Student Sheet

In these two experiments you will investigate how the halogen elements react with the different halide ions, chloride, bromide and iodide. You will also observe and explain how concentrated sulphuric acid reacts with halide ions.

Intended lesson outcomes

By the end of this practical you should be able to:

- describe the relative reactivity of the halogen elements as oxidising agents;
- describe and explain the reactions of halide ions with concentrated sulphuric acid;
- describe and explain redox processes in terms of electron transfer and/or changes of oxidation number.

Experiment 1. Reactions of halogens with halide solutions

Background information



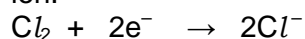

The Group VII elements are called halogens. They all accept one electron to form a halide ion.



Questions

- Write similar half-equations to the one above for bromine and iodine.
 - Using ideas of electron gain and loss, explain whether these half-equations are oxidation or reduction reactions.
 - Using oxidation numbers, explain whether these are oxidation or reduction half-reactions.

Safety

	You must wear eye protection throughout this experiment.
 	Chlorine solution is irritant and liberates a toxic gas . Asthmatics need to be particularly careful. Use of a fume cupboard is advised.
 	Bromine solution is harmful and irritant (use of a fume cupboard is advised), and is dangerous to the environment

Procedure

You have three halogen solutions, chlorine water, bromine water and iodine water. You also have test tubes containing potassium chloride, potassium bromide and potassium iodide.

- Place a piece of universal indicator paper on a white tile.

- Use a glass stirring rod to transfer a few drops of the first halogen solution in the table below onto the indicator paper and repeat with fresh paper for the other two solutions. Record your results in the table.
- Add some chlorine solution separately to test tubes containing solutions of potassium bromide and potassium iodide. Record your observations in the table below.
- Now mix solutions of bromine with potassium chloride and potassium iodide solutions and fill in the next row of the table.
- Repeat using mixtures of iodine solution and potassium chloride and iodine solution and potassium bromide. Record your results in the table.

	<i>effect on indicator paper</i>	<i>reaction with potassium chloride solution</i>	<i>reaction with potassium bromide solution</i>	<i>reaction with potassium iodide solution</i>
<i>chlorine water</i>				
<i>bromine water</i>				
<i>iodine water</i>				

Questions

- Which halogen solution has the greatest effect on the indicator paper?
- Write balanced ionic equations for the reactions that occurred between halogen solutions and halide solutions.
- Which halogen is the strongest oxidising agent and which halogen is the least oxidising?

Experiment 2. Reactions of solid halides with concentrated sulphuric acid

Background information

Concentrated sulphuric acid reacts with solid halides to form the corresponding hydrogen halide.

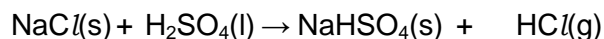

The reaction is complicated by the fact that concentrated sulphuric acid is an oxidising agent. Hydrogen chloride and chloride ions are the most difficult to oxidise and concentrated sulphuric acid is not a strong enough oxidising agent to oxidise them.



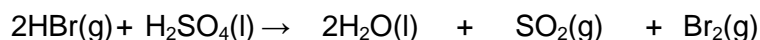

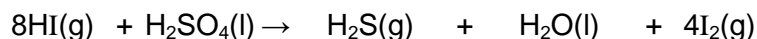

Hydrogen bromide and bromide ions are more easily oxidised.



Hydrogen iodide and iodide ions are even more easily oxidised by concentrated sulphuric acid, and sulphur dioxide, iodine and hydrogen sulphide are all produced.



Safety

	You must wear eye protection throughout this experiment.
	Concentrated sulphuric acid is corrosive .
	Ammonia solution is harmful
	and dangerous to the environment
 	These reactions liberate harmful and toxic gases . Asthmatics need to be particularly careful. Everyone should use only the very small quantities suggested and avoid inhaling the vapours directly from the tubes.
	Potassium dichromate(VI) is toxic . Do not allow it to come in contact with your skin. Wear gloves when handling filter paper soaked with this solution.

Procedure

- Put about five sodium chloride crystals in the bottom of a boiling tube and add five drops of concentrated sulphuric acid.
- Test the emerging gas with damp indicator paper and blow across the mouth of the tube. Record your observations.
- Using a glass rod, hold a drop of ammonia solution near the mouth of the tube. Again, record what happens.
- Repeat Step 1 using a few crystals of potassium bromide or potassium iodide. Test the gases coming off firstly with filter paper soaked with potassium dichromate(VI)(aq), which will turn from orange to green in the presence of sulphur dioxide. Write down all the observations you make about these reactions. Look carefully at the 'Background information' to help you identify some of the products.

Questions

- Write the equation for the production of hydrogen iodide from sodium iodide before it is oxidised.
- What are the oxidation numbers of sulphur and chlorine in the first equation in the 'Background information' for this experiment?
- What changes of oxidation number occur for sulphur and bromine in the third equation in the 'Background information'?
- What changes of oxidation number occur in the last equation in the 'Background information'?
- A yellow solid may also be seen in the reaction with sodium iodide. What substance is this? What does this tell you about the reducing power of iodine?

21. Some redox reactions of halogens and halides – Teachers' Notes

These two experiments set the scene for understanding the relative oxidising and reducing powers of the halogens and their halide ions.

Learning outcomes

These are printed on the Student Sheet.

A suggested approach

This is a good opportunity to remind students about redox reactions, in terms of change of oxidation numbers. After the 'Background information' to Experiment 1, questions are provided to test their understanding. Following the necessary safety warnings, the students could then carry out the reactions. The first task is to consider the bleaching action of the halogens. This gives a clear indication that chlorine is the most reactive, easily bleaching the indicator paper. You could, as a summary, explain that the other reactions are called displacement reactions. As well as discussing the decrease in oxidising power as you descend Group VII, also mention that the reducing power of the halide ion increases as you go down the group.

Experiment 2 extends the ideas of redox reactions to the various reactions of halide ions with concentrated sulphuric acid, which is an oxidising agent. The 'Background information' to this experiment provides some of the theory behind the observations students will make. You will note that we suggest using very small quantities of the reagents and this should be reinforced prior to the practical work.

Technical information

Requirements per student/group:

Experiment 1

Potassium chloride solution (0.1 mol dm^{-3})*
 Potassium bromide solution (0.1 mol dm^{-3})*
 Potassium iodide solution (0.1 mol dm^{-3})*
 Chlorine solution (0.05 mol dm^{-3})* (**liberates toxic gas**)
 Bromine solution (0.05 mol dm^{-3})*
 Iodine solution (0.01 mol dm^{-3})*
 Ammonia solution – e.g. 2 mol dm^{-3}
 White tile
 Universal indicator paper
 Test tubes
 Test-tube rack

*It is not necessary for the concentrations of the above solutions to be highly accurate.

Experiment 2

Concentrated sulphuric acid
 A few crystals of sodium chloride, potassium bromide and potassium iodide
 Filter paper soaked with potassium dichromate(VI) solution
 Ammonia solution – e.g. 2 mol dm^{-3}
 Universal indicator paper
 Boiling tubes
 Test-tube rack, able to accommodate boiling tubes

Safety

The main points are included on the Student Sheet but it is the teacher's responsibility to ensure that a full risk assessment is carried out prior to the practical session. Sulphur dioxide and chlorine gas may be present in some of these reactions and asthmatics should be particularly careful not to inhale the vapours. A well-ventilated laboratory is essential. With iodine and concentrated sulphuric acid, some hydrogen sulphide is produced, which is toxic. Use of a fume cupboard is advisable.

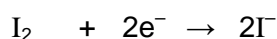
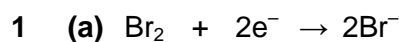
Answers to questions on the Student Sheet

(b) These are reduction half-reactions as electrons are gained.

(c) In both cases, the elements have an oxidation number of zero and this changes to -1 . As there is a decrease in oxidation number, these are reduction half-reactions.

2 Chlorine.



4 Chlorine is the strongest oxidising agent as it oxidises bromide and iodide to their respective halogens.

Iodine is the least oxidising agent because it will not oxidise bromide or chloride.

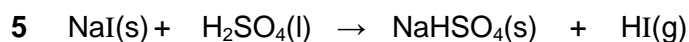

6 They do not change.

7 Bromine changes from -1 to 0 .

Sulphur changes from $+6$ to $+4$.

8 Iodine changes from -1 to 0 .

Sulphur changes from $+6$ in sulphuric acid to -2 in hydrogen sulphide.

9 The yellow solid is sulphur.

Iodine is the most powerful reducing agent out of the three halogens used.

25. Cracking hydrocarbons – Student Sheet

This experiment introduces you to the industrially important cracking reactions. Without them we would not be able to produce many of the organic chemicals on which we rely. We would also not be able to use most of the larger hydrocarbon molecules in crude oil.

Intended lesson outcomes

By the end of this practical you should:





- understand the importance of cracking large hydrocarbon molecules to produce more useful alkanes and alkenes of smaller M_r ;
- have continued to develop manipulative and observational skills.

Background information

The demand for petrol is greater than the amount produced by distilling crude oil. Large hydrocarbon molecules do not have much commercial use and these can be cracked to produce smaller molecules that can be converted into petrol. The other molecules that are produced in this reaction are hydrocarbon molecules called alkenes. These are very important in the synthesis of thousands of organic chemicals on which the world relies. The smallest alkene molecule is ethene and this is likely to be one of the alkenes present following a cracking reaction.

The cracking reaction you are going to perform uses a catalyst. The catalyst is able to hold hydrocarbon molecules on its surface until they are literally shaken apart as the C-C bonds break.

Safety

	You must wear eye protection throughout this experiment.
	Bromine water is harmful and irritant .
	Dilute, acidified aqueous potassium manganate(VII) is harmful
	and oxidising
	and dangerous to the environment .

Do not allow the water to suck back or the hot test tube will shatter. Using a Bunsen valve makes suck-back less likely.

Procedure

1. Add a depth of 2 cm of liquid alkane to a test tube and gently push down some mineral fibre using a stirring rod, allowing the complete absorption of the alkane.
2. Set up the apparatus as shown in Fig. 25.1.

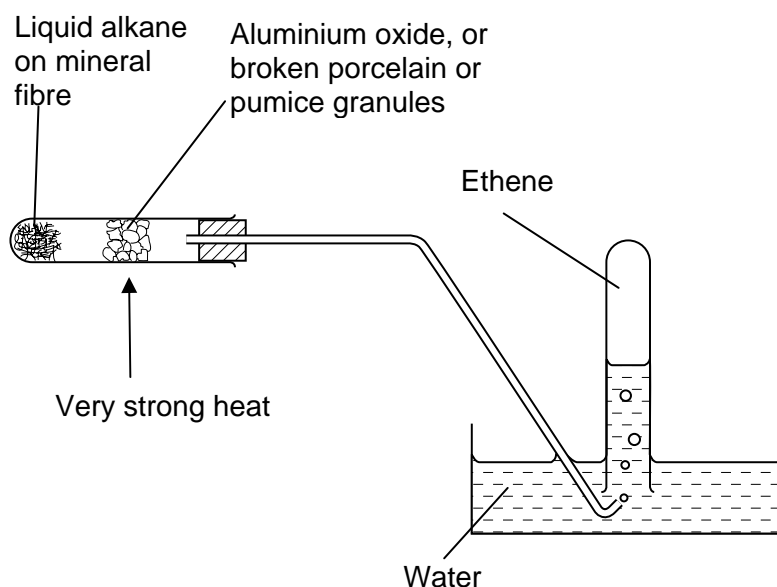

Figure 25.1

3. Heat the aluminium oxide (or broken porcelain/pumice granules) strongly for a few minutes, but be careful not to melt the rubber bung. Just flick the Bunsen flame onto the mineral fibre to ensure you collect a steady stream of bubbles.
4. Discard the first test tube of gas collected, then fill three test tubes with the gas coming off and stopper them.
5. As soon as the number of bubbles slows down, remove the apparatus from the water to avoid water being sucked up the delivery tube and cracking the hot test tube.
6. Carry out the following tests and record your results:
 - (a) What does the gas look like?
 - (b) What does the gas smell like?
 - (c) Use a lighted spill to see if the gas burns.
 - (d) Add two or three drops of dilute, aqueous bromine (the colour should be pale yellow) and shake. What do you observe?
 - (e) Add two drops of very dilute (pale pink), acidified potassium manganate(VII). Note the change of colour.

Questions

- 1 Why do you need to discard the first test tube of gas collected?
- 2 Does the gaseous alkene product have the same properties as alkanes?

25. Cracking hydrocarbons – Teachers' Notes

This experiment introduces students to the industrially important cracking of hydrocarbons to produce smaller alkanes and alkenes.

Learning outcomes

These are printed on the Student Sheet.

A suggested approach

Explain that crude oil is a mixture of many hydrocarbons. The gasoline fraction is used for petrol but the gasoline fraction on its own is not enough. Typically about 40% of the output of a distillation column may be required as petrol and this is why heavier fractions containing larger hydrocarbon molecules are cracked.

Students do not require foreknowledge of the properties of alkenes and this is a good linking experiment to the properties of alkanes.

Technical information

Requirements per student/group:

Liquid paraffin or decane

Bromine water (0.04 mol dm^{-3})* (**harmful and irritant**)

Very dilute, acidified potassium manganate(VII) solution – $\text{KMnO}_4(\text{aq})$ $0.001 \text{ mol dm}^{-3**}$
(**harmful and oxidising**)

Aluminium oxide granules, or broken porcelain chips or pumice granules

Hard glass test tube or hard glass boiling tube

Delivery tube with bung, preferably fitted with a Bunsen valve (see below)

Three test tubes to collect the gas

Trough or bowl

*The concentration does not have to be accurate but the solution should be a pale yellow colour.

** The concentration does not have to be accurate but the solution should be a pale pink colour.

Safety

The main points are included on the Student Sheet but it is the teacher's responsibility to ensure that a full risk assessment is carried out prior to the practical session. MSDS sheets should be consulted so that the correct action can be taken in event of a spillage and/or accident.

A Bunsen valve can be fitted onto the end of the delivery tube (Fig. 25.2).

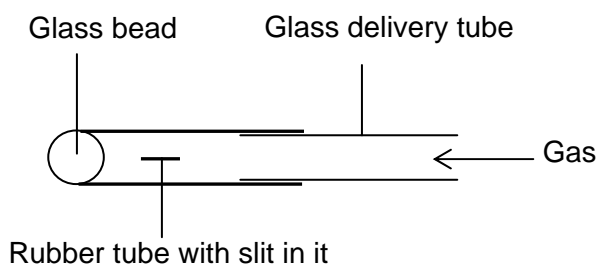

Figure 25.2 A Bunsen valve

Gas passes through the slit from the inside into the collection tube, but if the pressure drops inside the delivery tube, the sides of the slit are pushed together so water cannot enter. However, even with a Bunsen valve fitted, suck-back can still occur so always warn students to remove the delivery tube from the water if the rate of production of bubbles slows.

Keep checking that melted bungs do not block the delivery tube as an explosion could occur.

Answers to questions on the Student Sheet

- 1 The first test tube will contain mostly air.
- 2 The appearance is a colourless gas but the reaction with bromine water is an instant decolourisation due to the presence of the double bond.

28. Some reactions of alcohols – Student Sheet













In these experiments you will be introduced to some of the reactions of the alcohol functional group.

Intended lesson outcomes

By the end of this practical you should be able to recall the:

- combustion reaction of alcohols;
- reaction of alcohols with sodium;
- oxidation of ethanol to ethanal and ethanoic acid;
- dehydration of alcohols to alkenes;
- reaction of alcohols with carboxylic acids to form esters.

Safety

	You must wear eye protection throughout these experiments.
	Alcohols are highly flammable .
	Sodium is corrosive ,
	highly flammable , and undergoes a violent reaction with water .
	Fumes from burning sodium are highly irritant .
	Sodium dichromate(VI) is highly toxic
	and irritant .
	Dilute sulphuric acid (1 mol dm^{-3}) is irritant . Bromine water is harmful and irritant .
	Dilute, acidified aqueous potassium manganate(VII) is harmful
	and oxidising
	and dangerous to the environment
	Concentrated sulphuric acid and glacial ethanoic acid are corrosive .

Experiment 1. Combustion

Place about 1 cm³ of ethanol on a watch glass and ignite with a lighted spill. Record your observations.

Question

- 1 Write an equation for this reaction.

Experiment 2. Reaction with sodium

Put 1 cm³ of ethanol in an evaporating basin. Add to this a very small piece of sodium, the size of a rice grain. Record what you observe. Take great care not to allow sodium to come into contact with any water. Ensure all the sodium has reacted before you wash out the evaporating basin.

Questions

- 2 (a) The gas that comes off from this reaction is hydrogen and the other product is sodium ethoxide (C₂H₅O⁻Na⁺). Write a balanced equation for the reaction of sodium with ethanol.
(b) Write an equation for the reaction of sodium with water.

Experiment 3. Oxidation of ethanol

Put 3 cm³ of dilute sulphuric acid in a boiling tube and add a few drops of sodium dichromate(VI) solution. Add five drops of ethanol. Heat the mixture very gently until it just boils. Cautiously note the smell. Also record any colour change.

The experiment can be repeated with propan-2-ol and 2-methylpropan-2-ol.

Questions

- 3 (a) What does the colour of the solution suggest about what has happened to the dichromate(VI) ion?
(b) The new organic compound produced by heating ethanol is ethanal. The ethanal can be oxidised further to ethanoic acid. In the experiment you have done, this did not happen because the ethanal boiled off as soon as it was produced. What apparatus could be used to ensure the ethanal stays in contact with the oxidising agent?

Experiment 4. Dehydration of ethanol

1. Put ethanol in a test tube to a depth of 2 cm.
2. Use a stirring rod to push in some ceramic fibre, so as to soak up the ethanol.
3. Add aluminium oxide granules to the middle of the tube.
4. Heat the aluminium oxide strongly. Very occasionally, flick the flame onto the ceramic fibre, but only enough to ensure a steady stream of bubbles (figure 28.2).

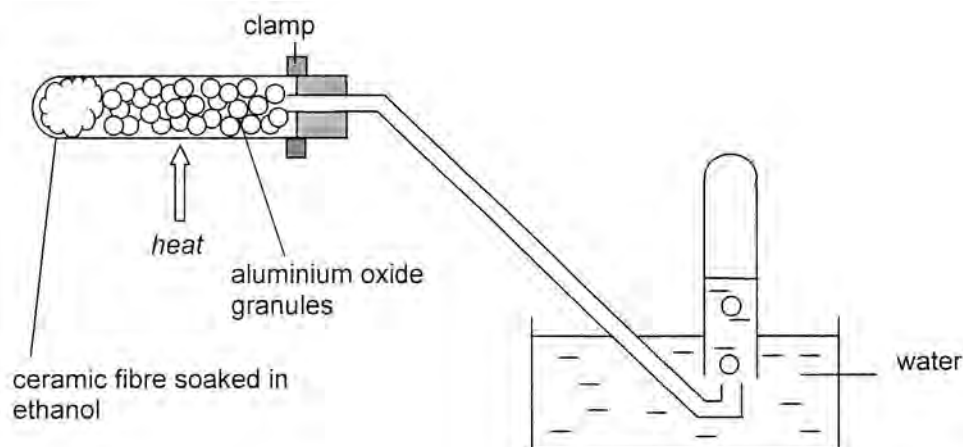

Figure 28.2

5. Discard the first test tube of gas collected and then collect three tubes of gas. Seal each with a bung.
6. Lift the whole apparatus out of the water to avoid suck-back as soon as you stop heating.
7. Light one tube of gas and record your observation.
8. Add two drops of dilute (pale yellow) bromine water to the second tube and shake gently. Record what you see.
9. Add two drops of very dilute (pale pink), acidified potassium manganate(VII). Note the change of colour.

Questions

- 4 (a) Why is the first test tube of gas discarded?
- (b) What is the identity of the gas tested?
- (c) Write an equation for the dehydration of ethanol.

Experiment 5. Ester formation

In a test tube, make a mixture of 10 drops of ethanol, 5 drops of glacial ethanoic acid and 3 drops of concentrated sulphuric acid. Put hot (recently boiled) water into a 250 cm³ beaker and warm the mixture for 5 minutes. Pour the liquid into about 20 cm³ of sodium carbonate solution. This will neutralise any remaining acid and allow you to smell the sweet aroma produced by the ester.

Question

- 5 The ester produced is ethyl ethanoate (CH₃COOC₂H₅) and the formula for ethanoic acid is CH₃COOH. Write a balanced equation for this esterification reaction.

28. Some reactions of alcohols – Teachers' Notes

These experiments introduce students to some reactions of the alcohol functional group.

Learning outcomes

These are printed on the Student Sheet.

A suggested approach

Ensure at the outset that students understand that they are going to do five experiments that are potentially hazardous. Take them through the various hazards associated with each of the compounds they are going to use. The experiments are perfectly safe if instructions are followed carefully and if students stick to the volumes suggested.

The questions on the Student Sheet are designed to make students consider the reactions that they observe. The practical session could be followed by a theory lesson explaining what they have observed.

Technical information

Requirements per student/group:

Ethanol

Sodium (the size of a rice grain)

Sodium dichromate(VI) 0.1 mol dm^{-3}

Dilute sulphuric acid (1 mol dm^{-3})

If desired, propan-2-ol and 2-methylpropan-2-ol

Aluminium oxide granules – 10 g

Ceramic fibre

Bromine water (0.04 mol dm^{-3})*

Very dilute, acidified potassium manganate(VII) solution – $\text{KMnO}_4(\text{aq})$ $0.001 \text{ mol dm}^{-3**}$

(harmful and oxidising)

Concentrated sulphuric acid

Glacial ethanoic acid

Sodium carbonate solution – a spatula measure in 20 cm^3 water

Supply of hot (recently boiled) water for water baths

Evaporating basin

Dropper pipettes

250 cm^3 beaker

100 cm^3 beaker

10 cm^3 measuring cylinders

Hard glass test tubes

Hard glass boiling tubes

Test-tube rack

Delivery tube with bung, preferably fitted with a Bunsen valve (see below)

*The concentration does not have to be accurate but the solution should be a pale yellow colour.

** The concentration does not have to be accurate but the solution should be a pale pink colour.

Safety

The main points are included on the Student Sheet but it is the teacher's responsibility to ensure that a full risk assessment is carried out prior to the practical session. As for practical 25, using a Bunsen valve minimises the risk of suck-back.

However, this can still occur, so always warn students to remove the delivery tube from the water if the rate of production of bubbles slows. Keep checking that melted bungs do not block the delivery tube as an explosion could occur. MSDS sheets should be consulted so that the correct action can be taken in event of a spillage and/or accident.

Answers to questions on the Student Sheet

- 1 $\text{C}_2\text{H}_5\text{OH}(\text{l}) + 3\text{O}_2(\text{g}) \rightarrow 2\text{CO}_2(\text{g}) + 3\text{H}_2\text{O}(\text{l})$
- 2 (a) $2\text{C}_2\text{H}_5\text{OH} + 2\text{Na} \rightarrow \text{C}_2\text{H}_5\text{O}^-\text{Na}^+ + \text{H}_2(\text{g})$
(b) $2\text{Na}(\text{s}) + 2\text{H}_2\text{O}(\text{l}) \rightarrow 2\text{NaOH}(\text{aq}) + \text{H}_2(\text{g})$
- 3 (a) The dichromate(VI) ion has been reduced from $\text{Cr}_2\text{O}_7^{2-}(\text{aq})$ (orange) to $\text{Cr}^{3+}(\text{aq})$ (green/blue).
(b) Reflux apparatus, i.e. a condenser fitted to a pear-shaped flask, could be used.
- 4 (a) The first test-tube of gas contains mostly air.
(b) Ethene.
(c) $\text{C}_2\text{H}_5\text{OH} \rightarrow \text{C}_2\text{H}_4 + \text{H}_2\text{O}$
- 5 $\text{CH}_3\text{COOH} + \text{C}_2\text{H}_5\text{OH} \rightarrow \text{CH}_3\text{COOC}_2\text{H}_5 + \text{H}_2\text{O}$

University of Cambridge International Examinations
1 Hills Road, Cambridge, CB1 2EU, United Kingdom
Tel: +44 1223 553554 Fax: +44 1223 553558 E-mail: international@cie.org.uk Website: www.cie.org.uk

© University of Cambridge International Examinations 2005
PSAS9701 0501