

Surname	Centre Number	Candidate Number
Other Names		2



GCE A level

1144/01



S15-1144-01

ELECTRONICS – ET4

P.M. TUESDAY, 9 June 2015

1 hour

For Examiner's use only		
Question	Maximum Mark	Mark Awarded
1.	4	
2.	8	
3.	9	
4.	8	
5.	6	
6.	11	
7.	4	
Total	50	

ADDITIONAL MATERIALS

In addition to this examination paper, you will need a calculator.

INSTRUCTIONS TO CANDIDATES

Use black ink or black ball-point pen.

Write your name, centre number and candidate number in the spaces at the top of this page.

Answer **all** questions.

Write your answers in the spaces provided in this booklet.

INFORMATION FOR CANDIDATES

The total number of marks available for this paper is 50.

The number of marks is given in brackets at the end of each question or part-question.

You are reminded of the necessity for good English and orderly presentation in your answers.

You are reminded to show all working. Credit is given for correct working even when the final answer given is incorrect.

INFORMATION FOR THE USE OF CANDIDATES

Preferred Values for resistors

The figures shown below and their decade multiples and sub-multiples are the E24 series of preferred values.

10, 11, 12, 13, 15, 16, 18, 20, 22, 24, 27, 30, 33, 36, 39, 43, 47, 51, 56, 62, 68, 75, 82, 91.

Standard Multipliers:

Prefix	Multiplier
T	$\times 10^{12}$
G	$\times 10^9$
M	$\times 10^6$
k	$\times 10^3$

Prefix	Multiplier
m	$\times 10^{-3}$
μ	$\times 10^{-6}$
n	$\times 10^{-9}$
p	$\times 10^{-12}$

Filters

$$f_b = \frac{1}{2\pi RC}$$

Break frequency for high pass and low pass filters

$$X_C = \frac{1}{2\pi fC}$$

Capacitive reactance

$$X_L = 2\pi fL$$

Inductive reactance

$$Z = \sqrt{R^2 + X_C^2}$$

For a series RC circuit

$$f_0 = \frac{1}{2\pi\sqrt{LC}}$$

Resonant frequency

$$R_D = \frac{L}{r_L C}$$

Dynamic resistance

$$Q = \frac{2\pi f_0 L}{r_L}$$

$$Q = \frac{f_0}{B}$$

Modulation

$$m = \frac{(V_{\max} - V_{\min})}{(V_{\max} + V_{\min})} \times 100\%$$

Depth of modulation

$$\beta = \frac{\Delta f_c}{f_i}$$

Modulation index

$$\text{resolution} = \frac{\text{i/p voltage range}}{2^n}$$

PCM

$$\text{Bandwidth} = 2(\Delta f_c + f_i)$$

$$\text{Bandwidth} = 2(1+\beta)f_i$$

Transmitted FM Bandwidth

Radio receivers

$$C = \frac{1}{4\pi^2 f_0^2 L}$$

BLANK PAGE

Answer all questions.

1. The input signal and output signal for a Schmitt trigger circuit are shown below.

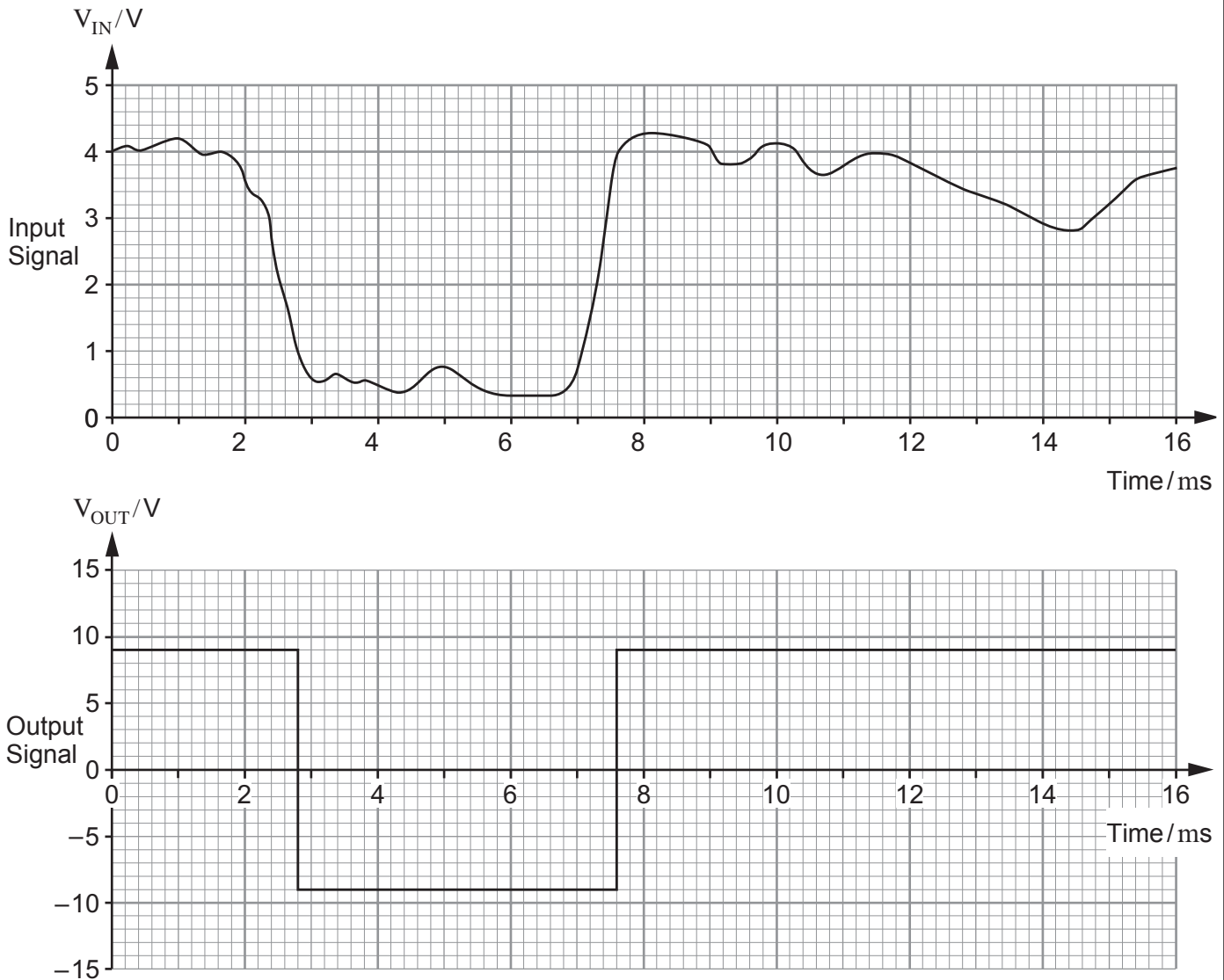

- (a) What type of Schmitt trigger would be required to produce this output?

[1]

.....

(b) Draw the switching characteristic for this Schmitt trigger.

[3] Examiner only

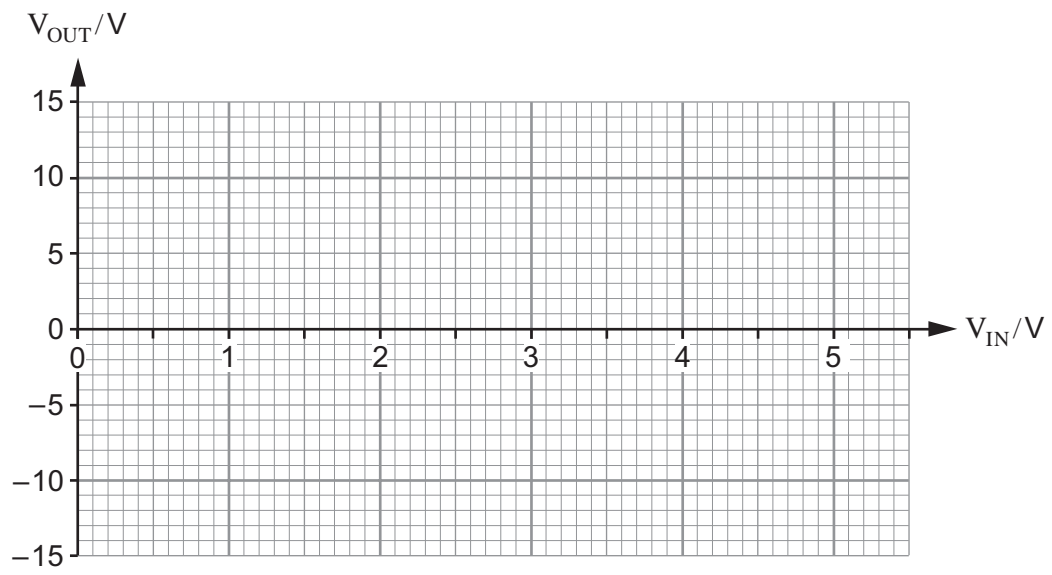

2. (a) A 18 kHz sinusoidal wave is amplitude modulated onto a 300 kHz carrier wave. On the axes below, draw the frequency spectrum of the transmitted wave. Label **all** significant frequencies. [3]

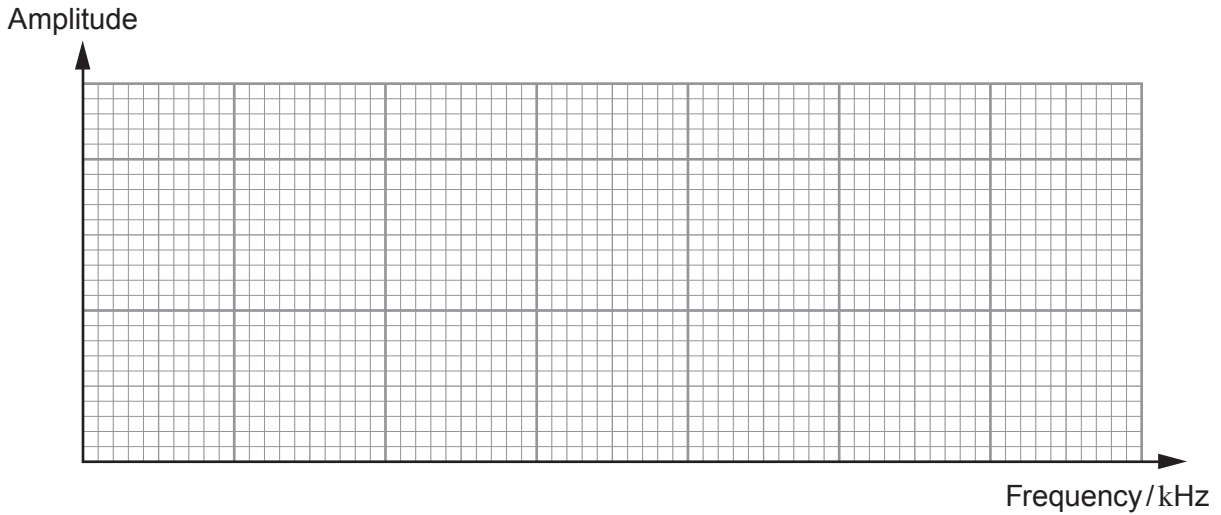

- (b) The 18 kHz sinusoidal wave is now replaced with an audio signal containing frequencies in the range 250 Hz – 18 kHz. The carrier signal frequency remains at 300 kHz.

- (i) On the axes below, draw the frequency spectrum of the transmitted wave. [1]

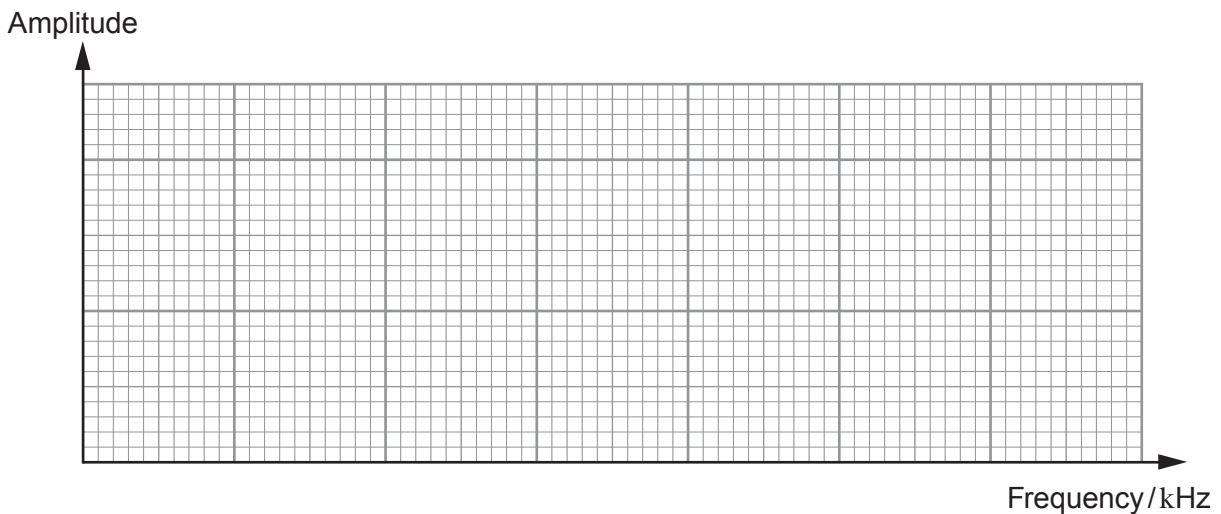

- (ii) What is the broadcast bandwidth of the signal? [1]

.....

(c) The following diagram shows a **different** Amplitude Modulated signal.

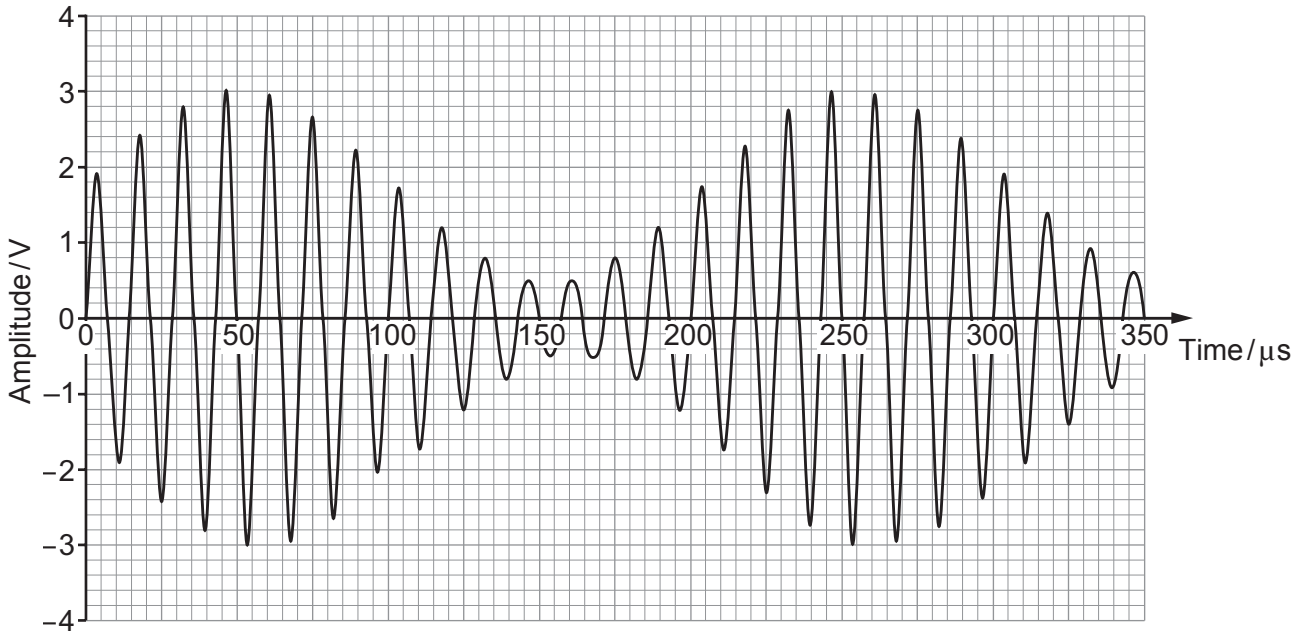

Determine:

(i) the carrier frequency; [1]

.....

.....

(ii) the frequency of the sinusoidal signal used to modulate the carrier; [1]

.....

.....

(iii) the depth of modulation. [1]

.....

.....

3. (a) The circuit diagram for a simple radio receiver is shown below.

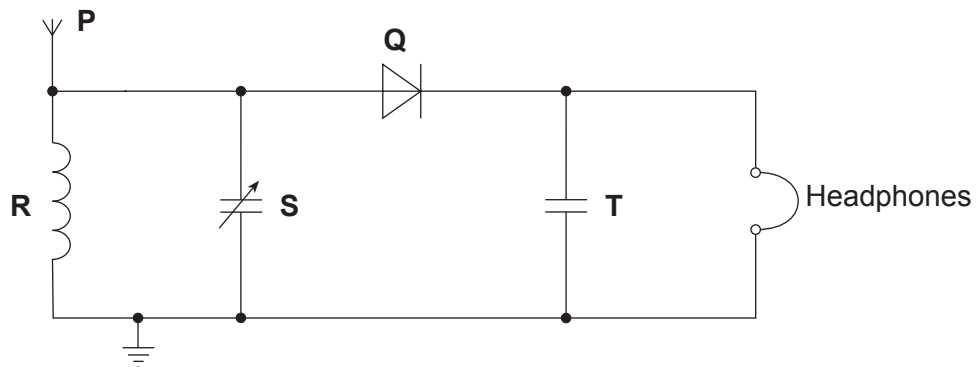

Use the letters **P – T** to answer the following questions.

- (i) Which component removes the RF carrier to leave the audio signal? [1]
- (ii) Which component changes the RF signal to give a non-zero average signal? [1]
- (iii) Which components select the required RF signal? [1]
- (iv) Name a component that carries many RF signals at all times. [1]

(b) The simple radio receiver has two significant weaknesses, namely *poor selectivity* and *poor sensitivity*. Explain what you understand by the terms:

- (i) *poor selectivity*; [1]

.....

.....

.....

.....

- (ii) *poor sensitivity*. [1]

.....

.....

.....

.....

- (c) The superheterodyne radio receiver offers considerable improvement compared to the simple radio receiver. **Part** of the superheterodyne receiver is shown below:

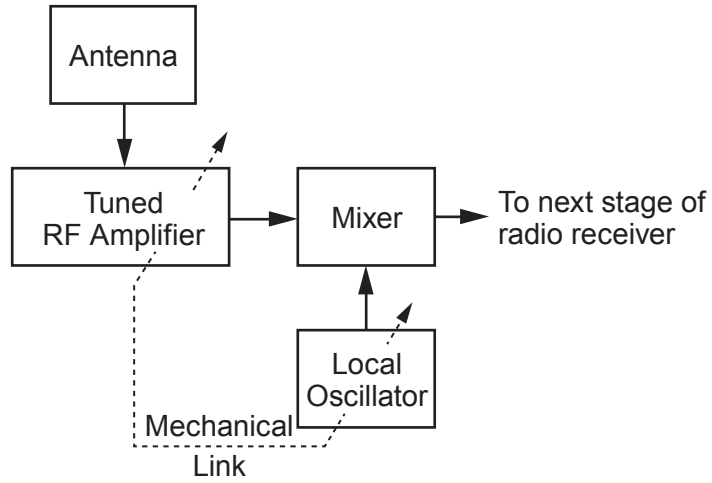

- (i) The tuned RF amplifier has been tuned to a frequency of 1.680 MHz. The local oscillator output is measured at 2.145 MHz. What **four** frequency signals will be present at the output of the mixer?
- I.
 - II.
 - III.
 - IV.
- [2]
- (ii) Which of these frequencies is the intermediate frequency?
-
- [1]

4. The ASCII code is an internationally agreed method of coding alphanumeric characters in computer systems.

The following table gives the ASCII code for some characters.

Character	ASCII Code
m	1101101
p	1110000
U	1110101
W	1010111
Y	1011001

- (a) The diagram below shows the transmitted signal for one of these characters using **even** parity.

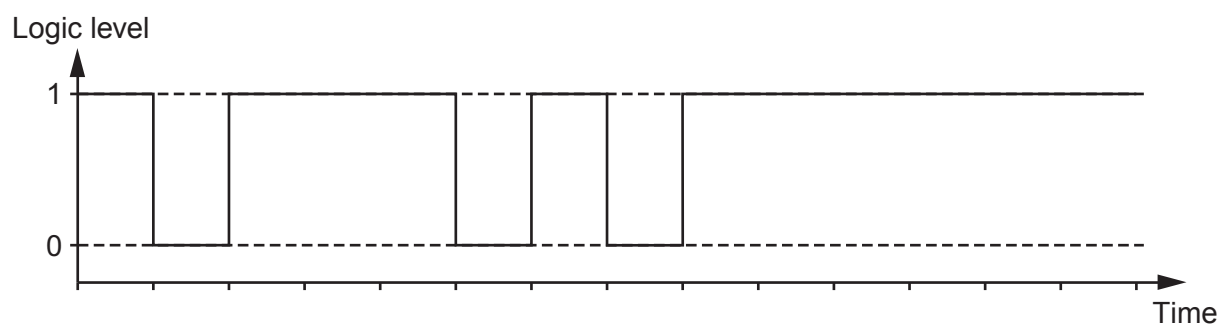

- (i) **Label** the start, stop and parity bits. [3]

- (ii) Identify the transmitted **character**.

Character = [1]

(b) An asynchronous data transmission system uses a five bit parity system, with the parity bits assigned to the data bits as shown in the following table.

D ₇	D ₆	D ₅	D ₄	D ₃	D ₂	D ₁	D ₀	P ₄	P ₃	P ₂	P ₁	P ₀
				x	x	x	x					x
x	x	x	x								x	
		x	x			x	x			x		
	x	x			x	x			x			
x	x			x	x			x				

(i) The following data is transmitted.

D ₇	D ₆	D ₅	D ₄	D ₃	D ₂	D ₁	D ₀	P ₄	P ₃	P ₂	P ₁	P ₀
1	1	0	1	0	0	1	0					

Complete the table with the values of the parity bits P₄ – P₀ for an **odd** parity system. [2]

(ii) The following data and parity bits are received from the system using **odd** parity.

D ₇	D ₆	D ₅	D ₄	D ₃	D ₂	D ₁	D ₀	P ₄	P ₃	P ₂	P ₁	P ₀
0	1	1	0	1	1	0	0	1	0	0	1	0

There is a **single** error.

I. Which parity bit(s) fail the parity test? [1]

II. Locate the error and write down the corrected data and parity bits. [1]

D ₇	D ₆	D ₅	D ₄	D ₃	D ₂	D ₁	D ₀	P ₄	P ₃	P ₂	P ₁	P ₀

5. Pulse Position Modulation (PPM), Pulse Width Modulation (PWM) and Pulse Code Modulation (PCM) are three methods of modulating information.

(a) On each of the following graphs, illustrate what would happen to the unmodulated clock pulse train (shown by the dotted lines) if the signal below was transmitted using:

- (i) PPM;
- (ii) PWM.

[4]

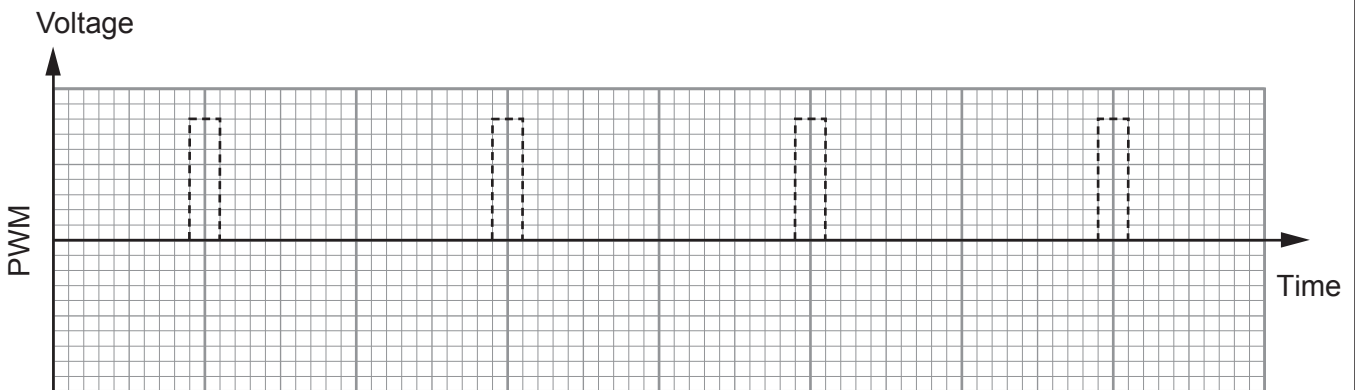
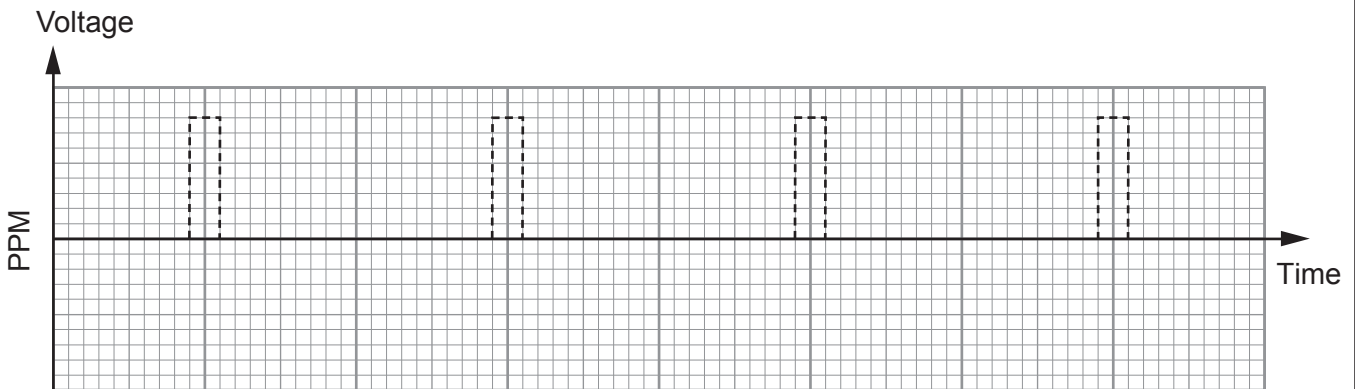
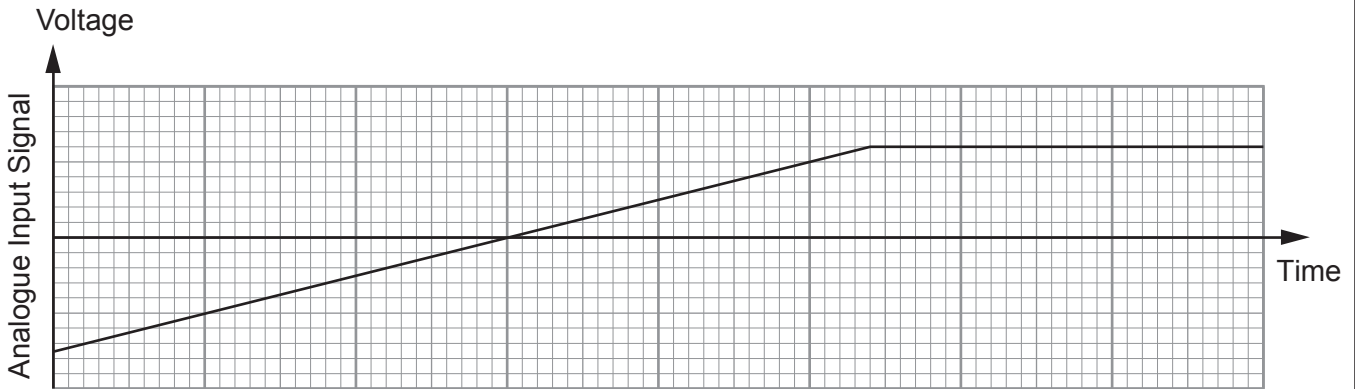

- (b) A PCM transmitter requires an ADC with a **minimum** resolution of $500\mu\text{V}$. The input voltage range is 5V.

What is the minimum number of bits needed for the ADC output to provide this resolution?
[2]

.....

.....

.....

Examiner
only

6. The following circuit diagram shows the IF filter from a Superhet receiver connected to a signal generator.

- The inductor has a resistance r_L of 2.5Ω .
- The frequency is varied to find the maximum value of V_{OUT} .
- The amplitude of V_{IN} remains at $10V$ throughout.

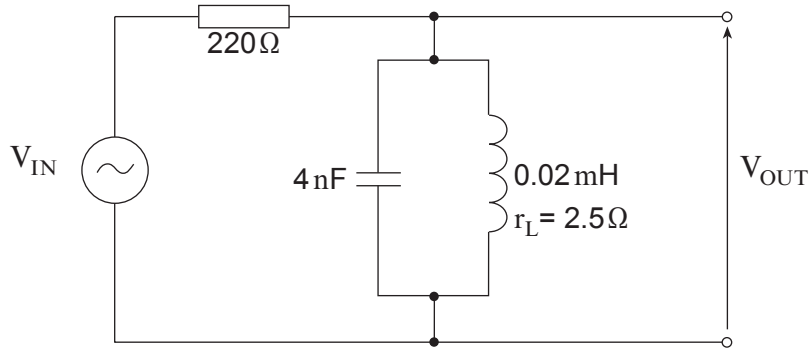

(a) Calculate the frequency at which V_{OUT} is a maximum. [2]

.....

.....

.....

(b) Calculate the Dynamic Resistance, R_D of the filter. [2]

.....

.....

.....

(c) Use your answer to part (b) to determine the maximum value of the voltage V_{OUT} with V_{IN} set to $10V$. [2]

.....

.....

.....

(d) Determine the 'Q factor' of this circuit. [1]

.....

.....

.....

(e) Determine the bandwidth of this filter.

[1]

.....

.....

.....

(f) Sketch the frequency response of the filter using the axes below.

Label, with **numerical values** the:

- (i) peak output voltage;
- (ii) resonant frequency;
- (iii) bandwidth.

[3]

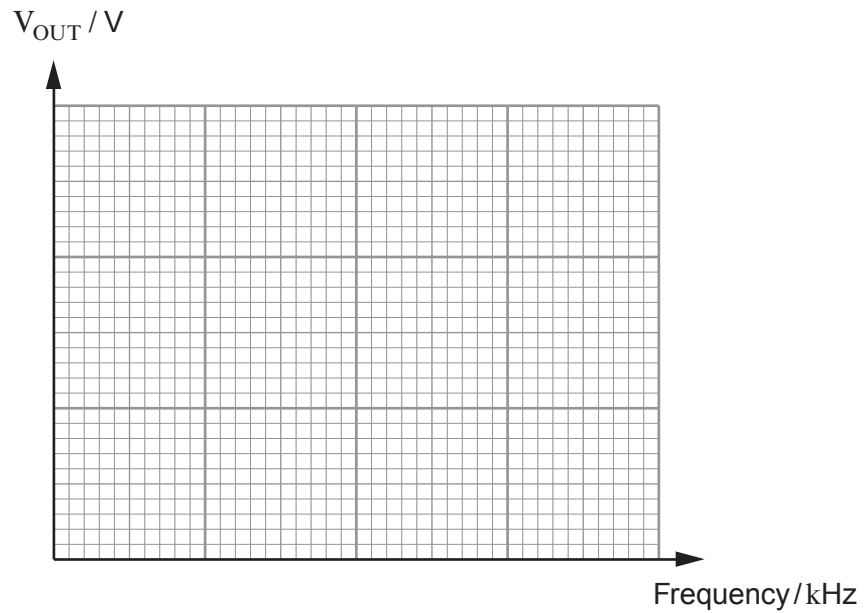

TURN OVER FOR THE LAST QUESTION

7. In the following Schmitt trigger circuit the op-amp saturates at $\pm 12\text{V}$.

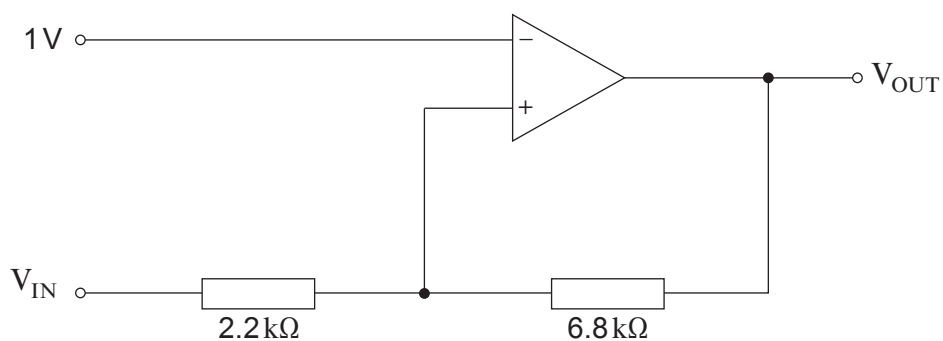

- (a) Calculate the value of V_{IN} which causes V_{OUT} to change from $+12\text{V}$ to -12V . [2]

.....

.....

.....

.....

.....

.....

.....

- (b) Calculate the value of V_{IN} which causes V_{OUT} to change from -12V to $+12\text{V}$. [2]

.....

.....

.....

.....

.....

.....

.....

END OF PAPER