

**PLEASE NOTE**  
 THESE NOTES ARE STILL  
 BEING DEVELOPED  
 The colour changes are  
 only approximate

# COBALT

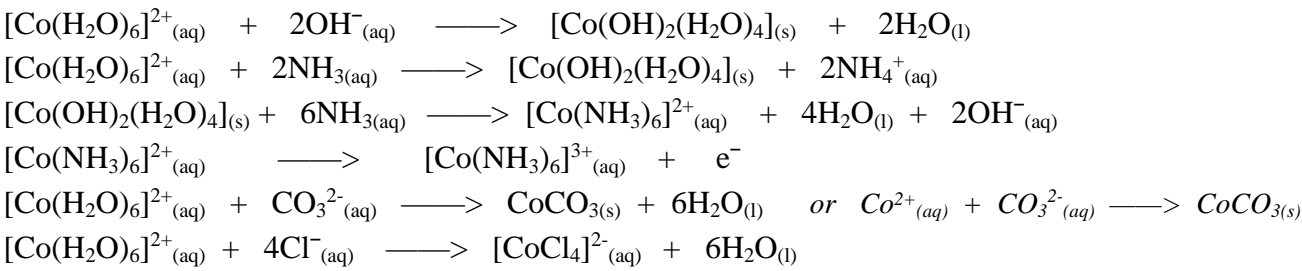

# COPPER

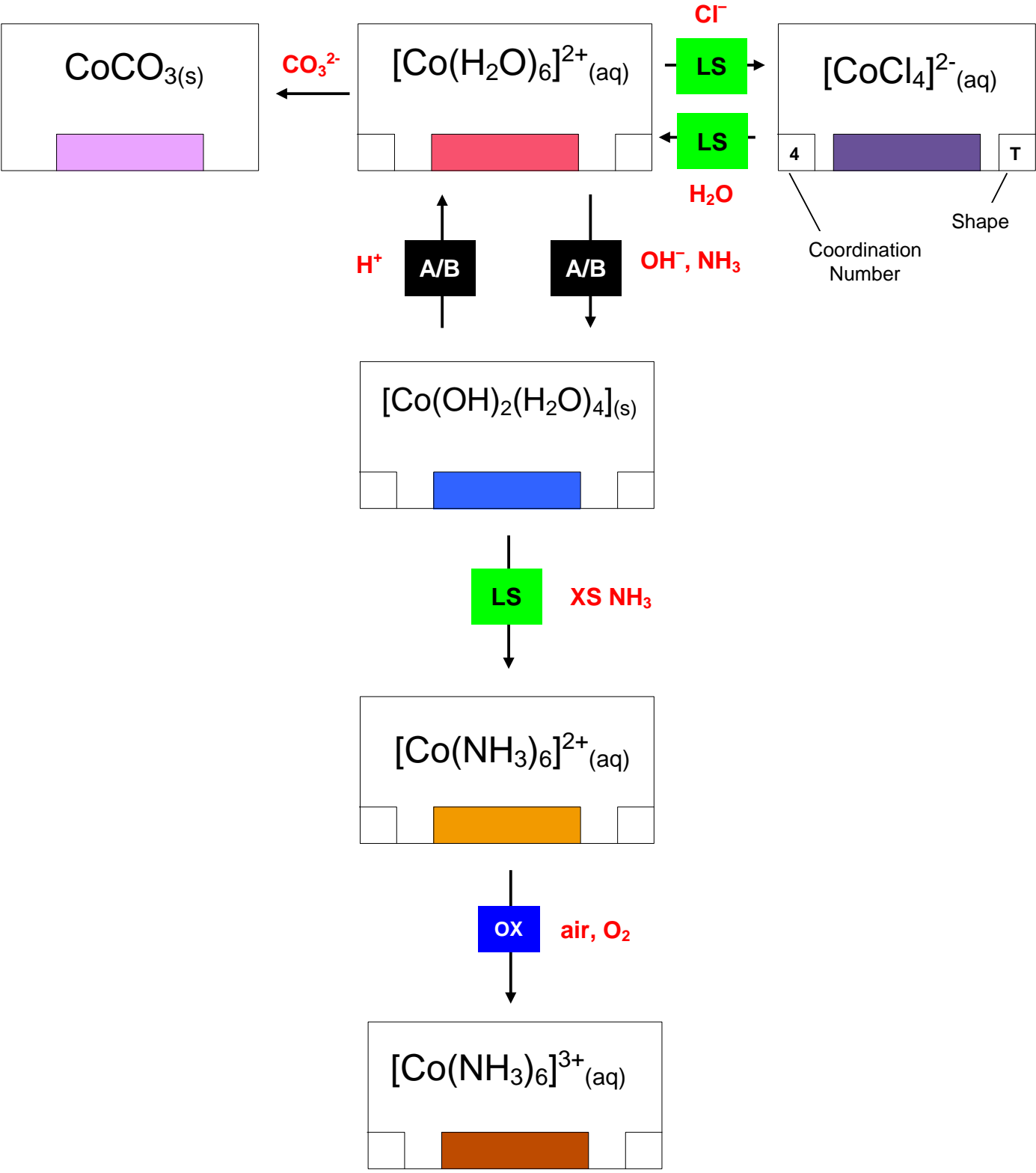
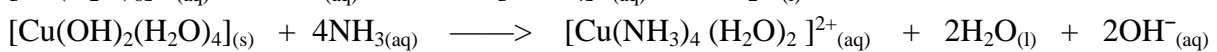
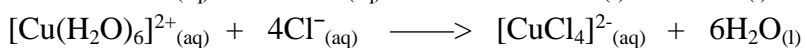
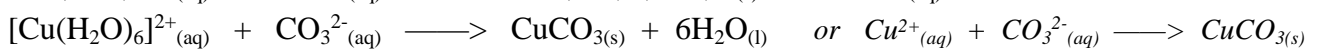
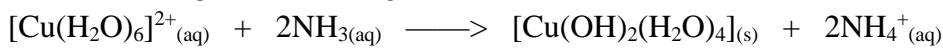
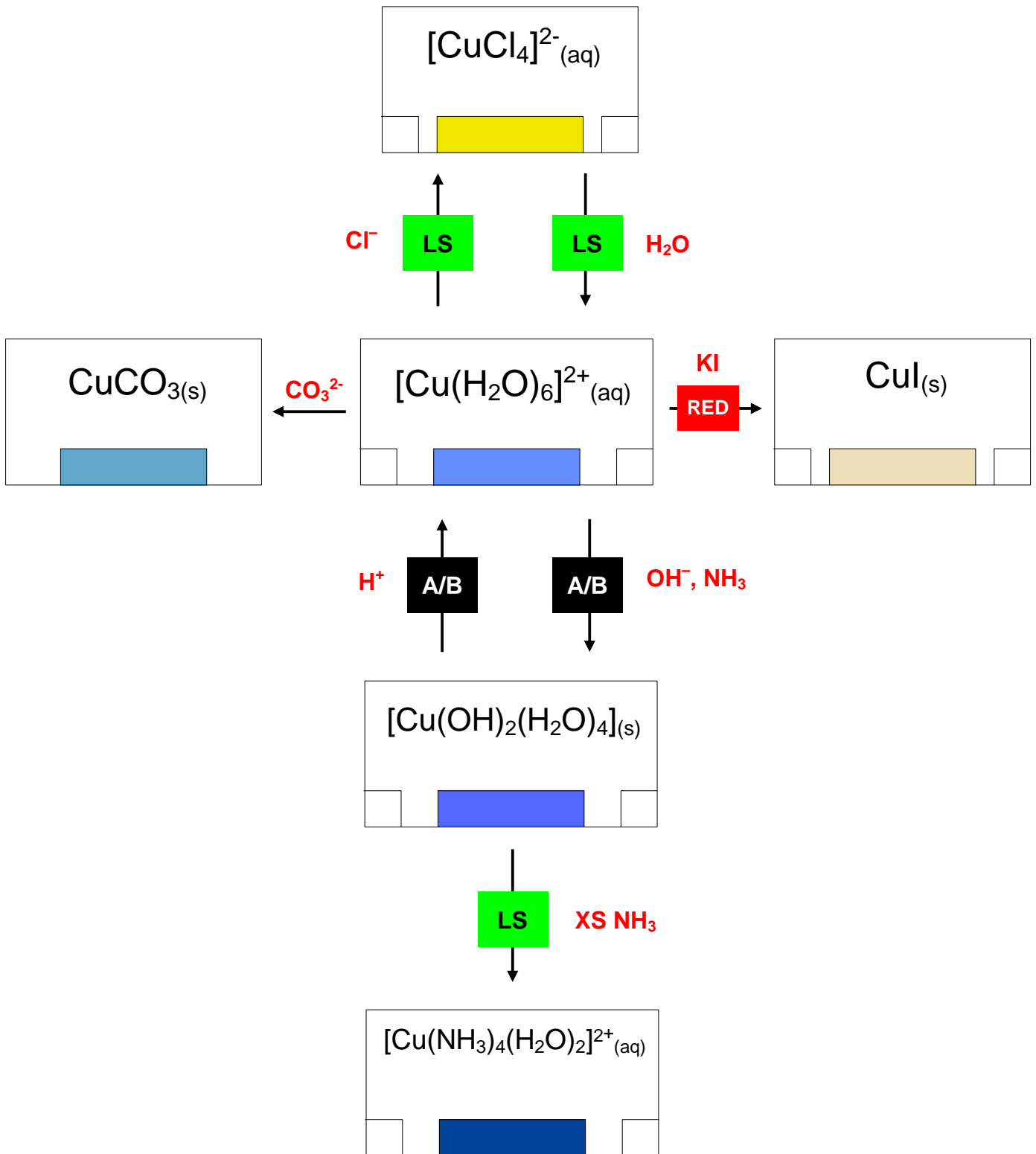

# IRON

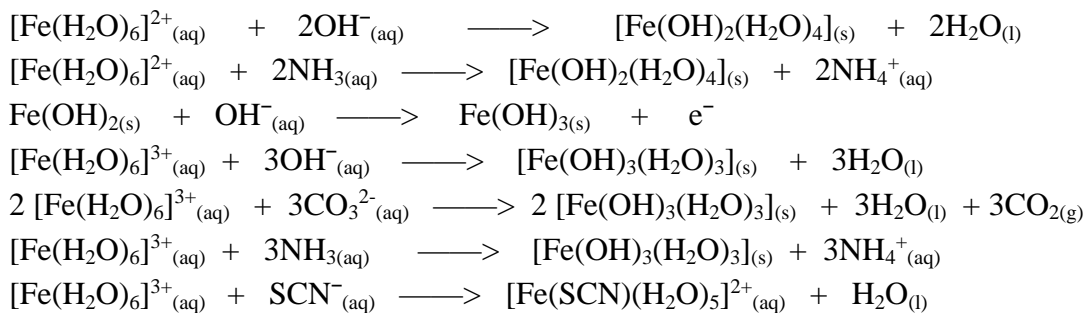
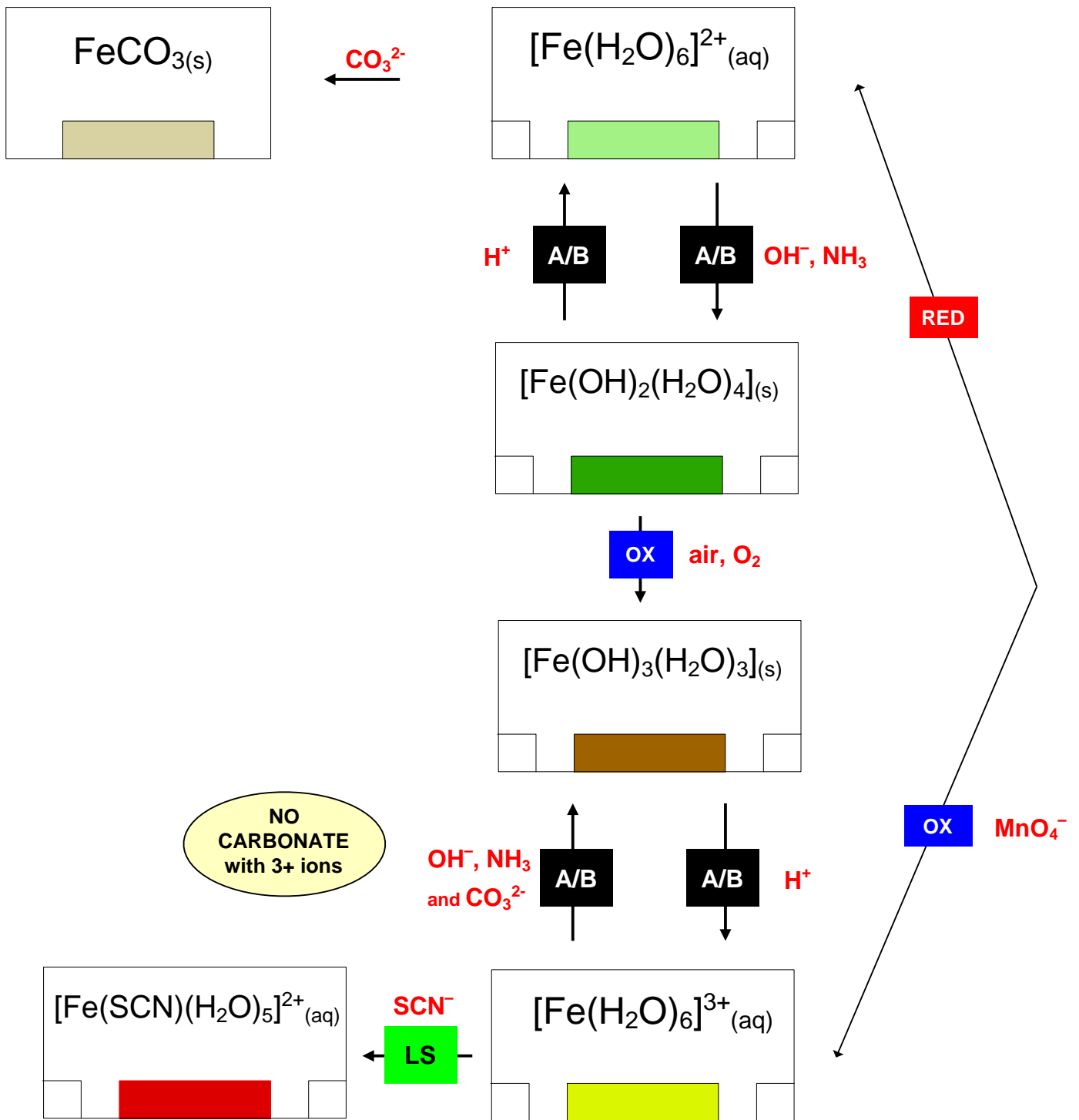

# CHROMIUM

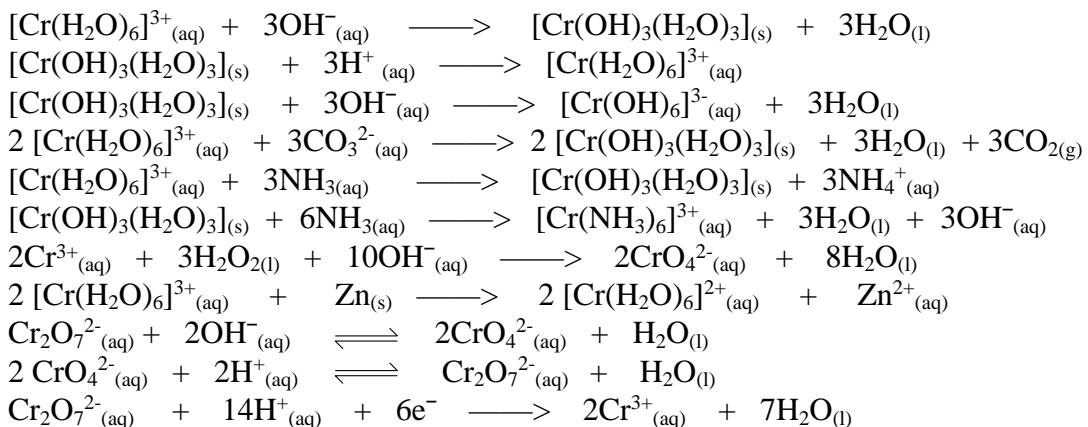
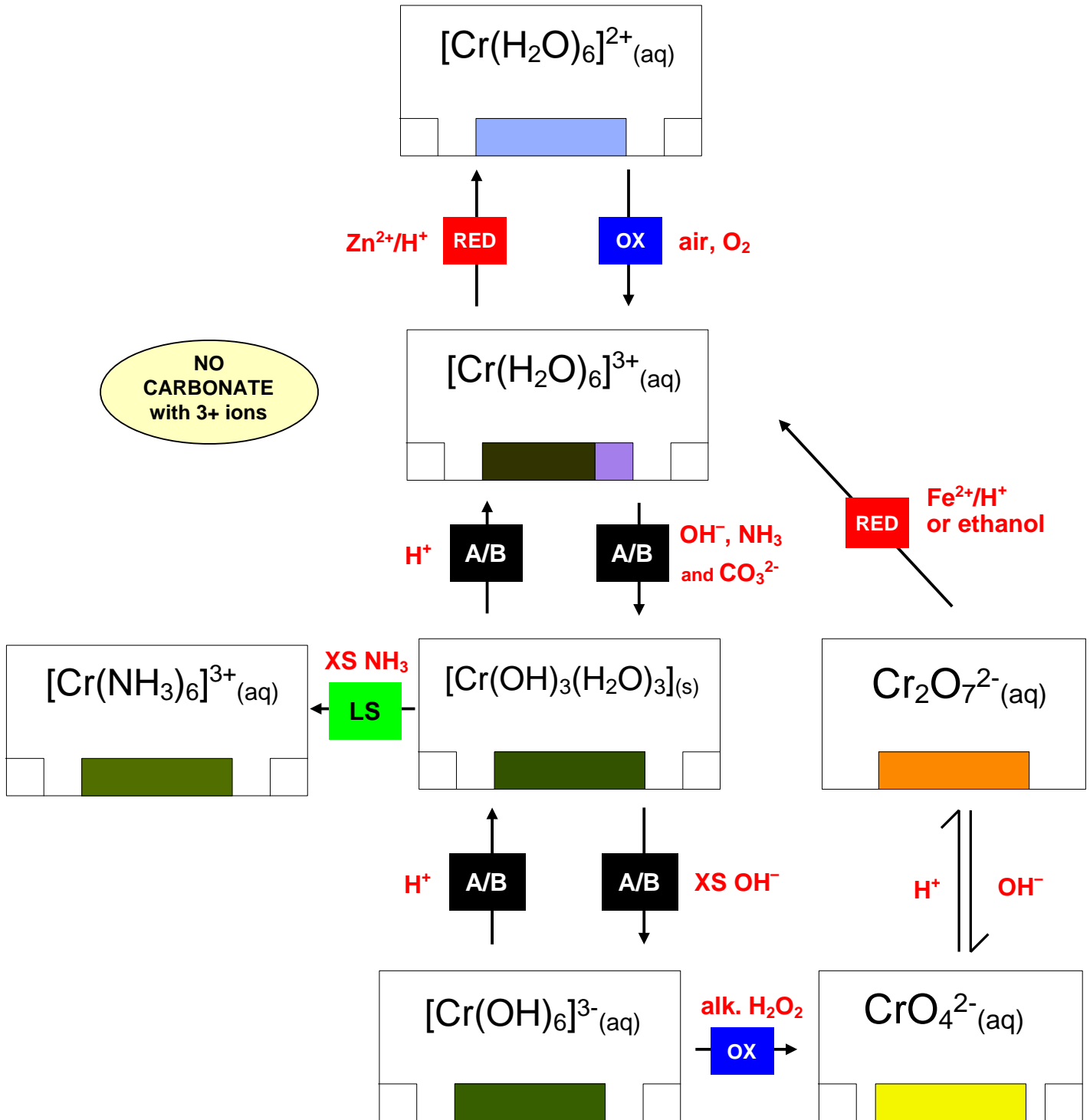

# ALUMINIUM

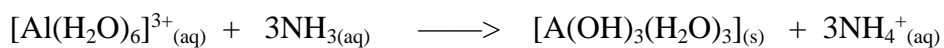
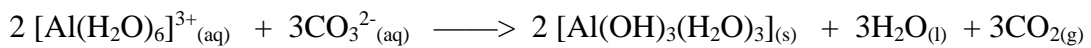
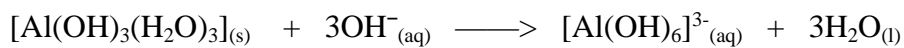
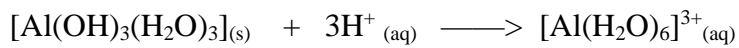
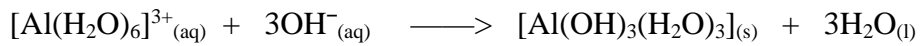
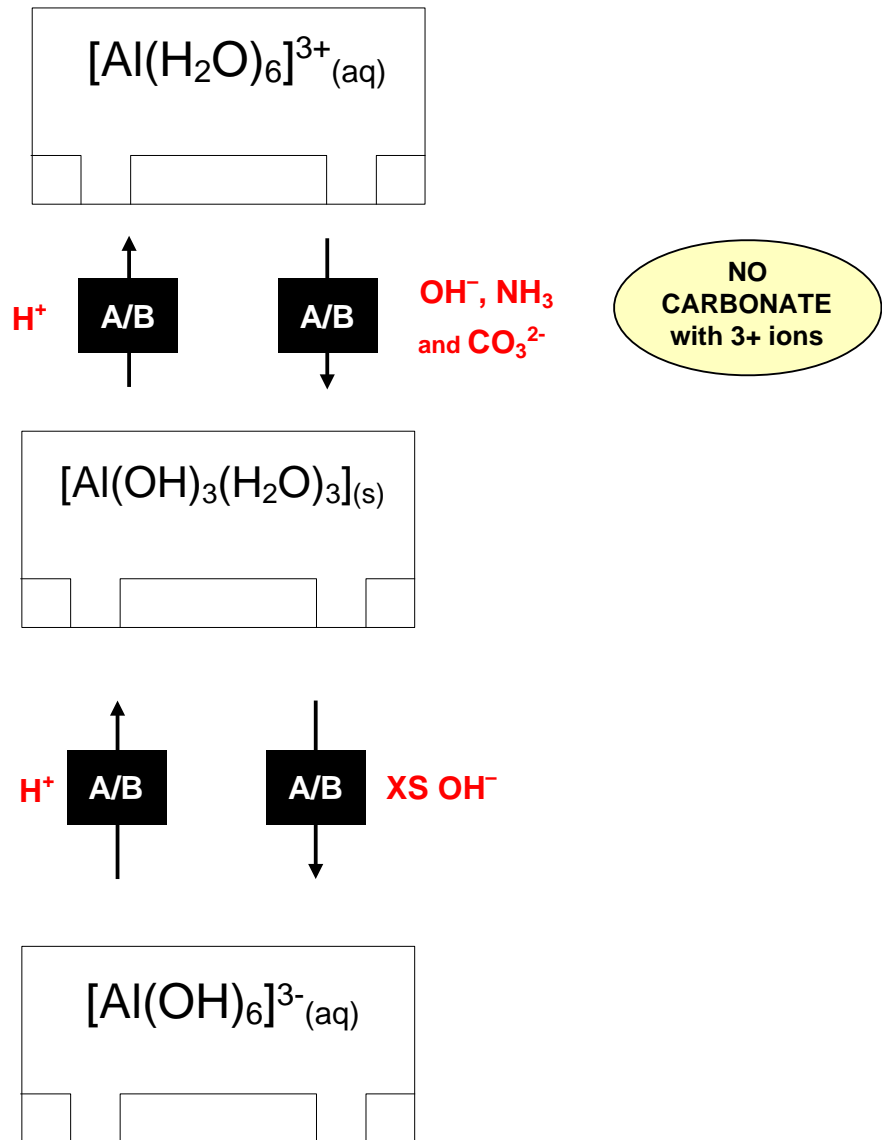

**PLEASE NOTE**  
 THESE NOTES ARE STILL  
 BEING DEVELOPED

Colour in the rectangles and  
 add the shape / CNo.

# COBALT

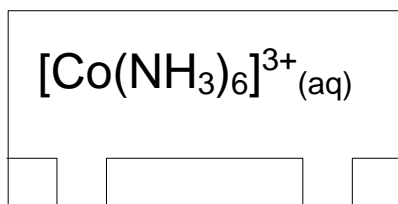
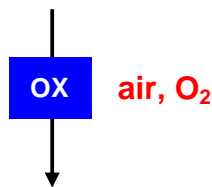
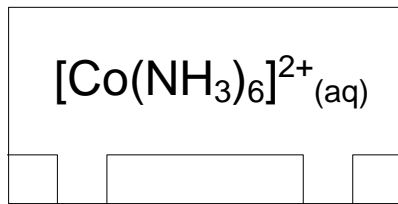
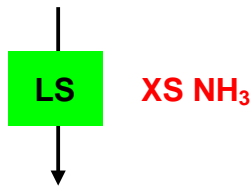
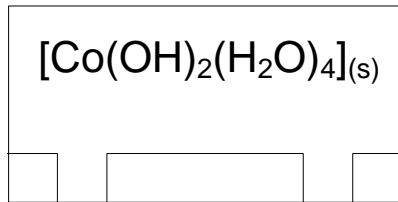
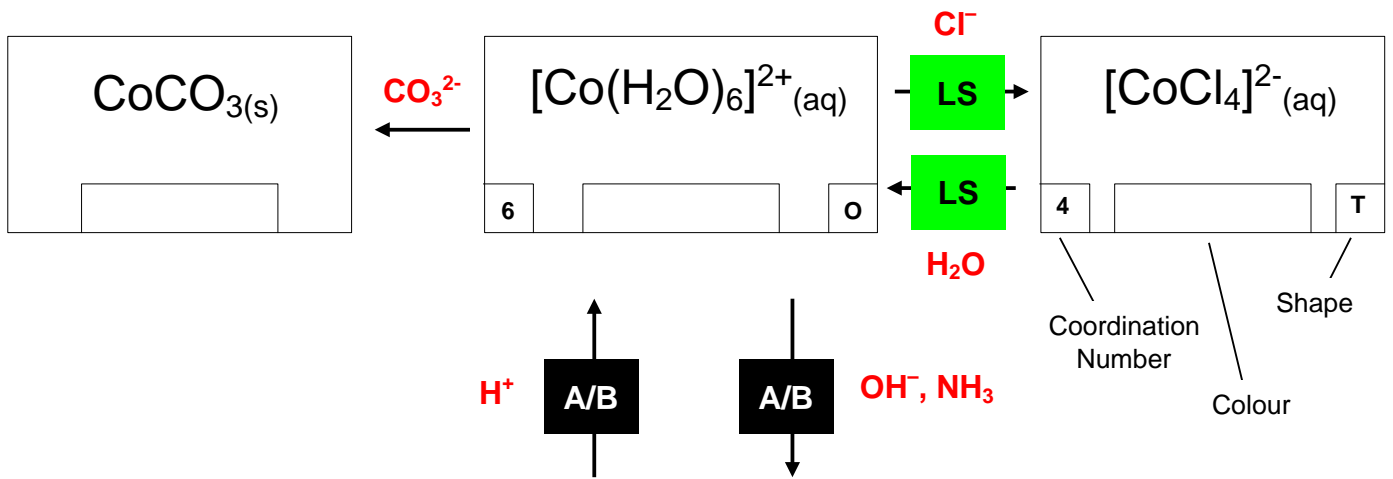

# COPPER

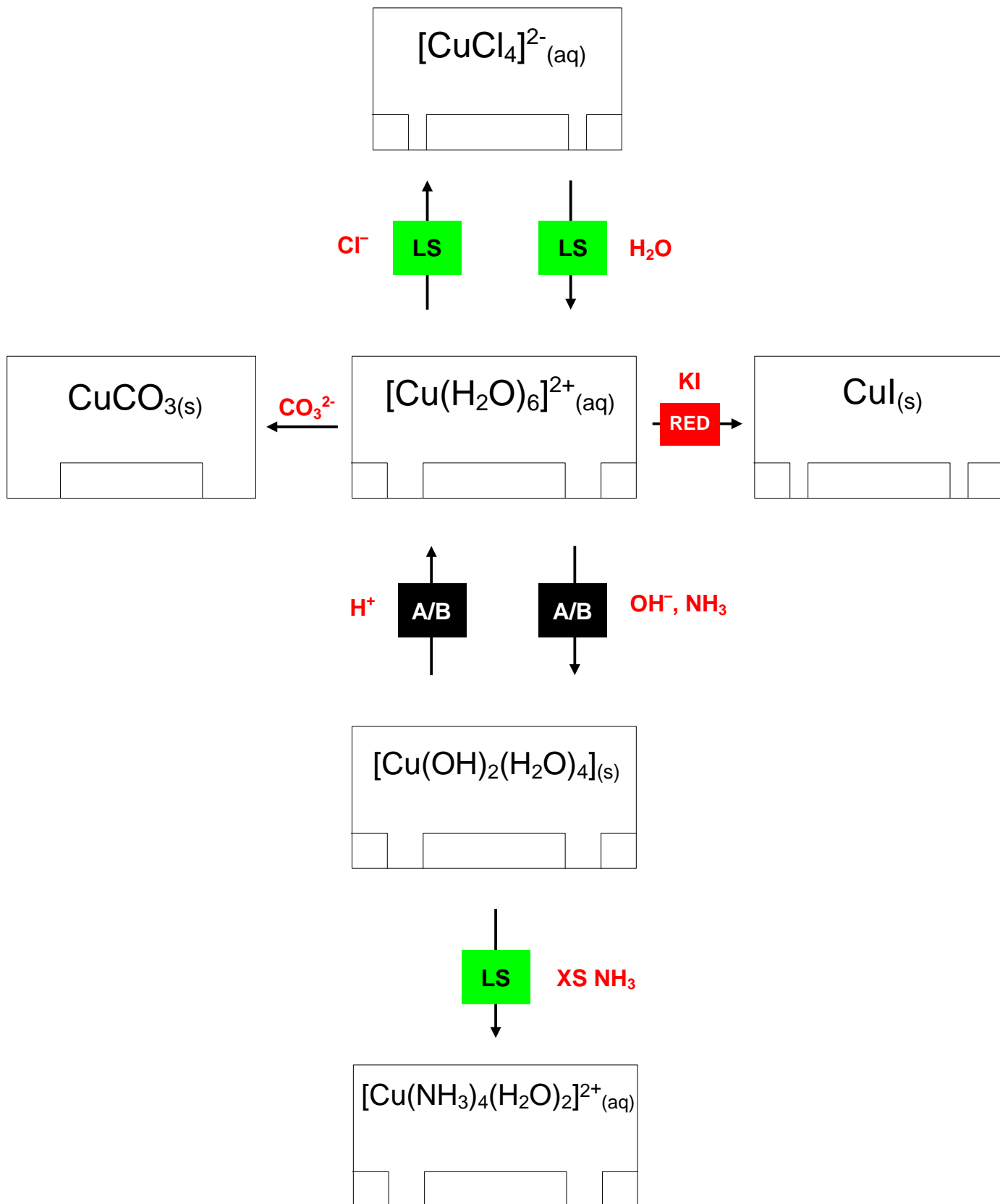

# IRON

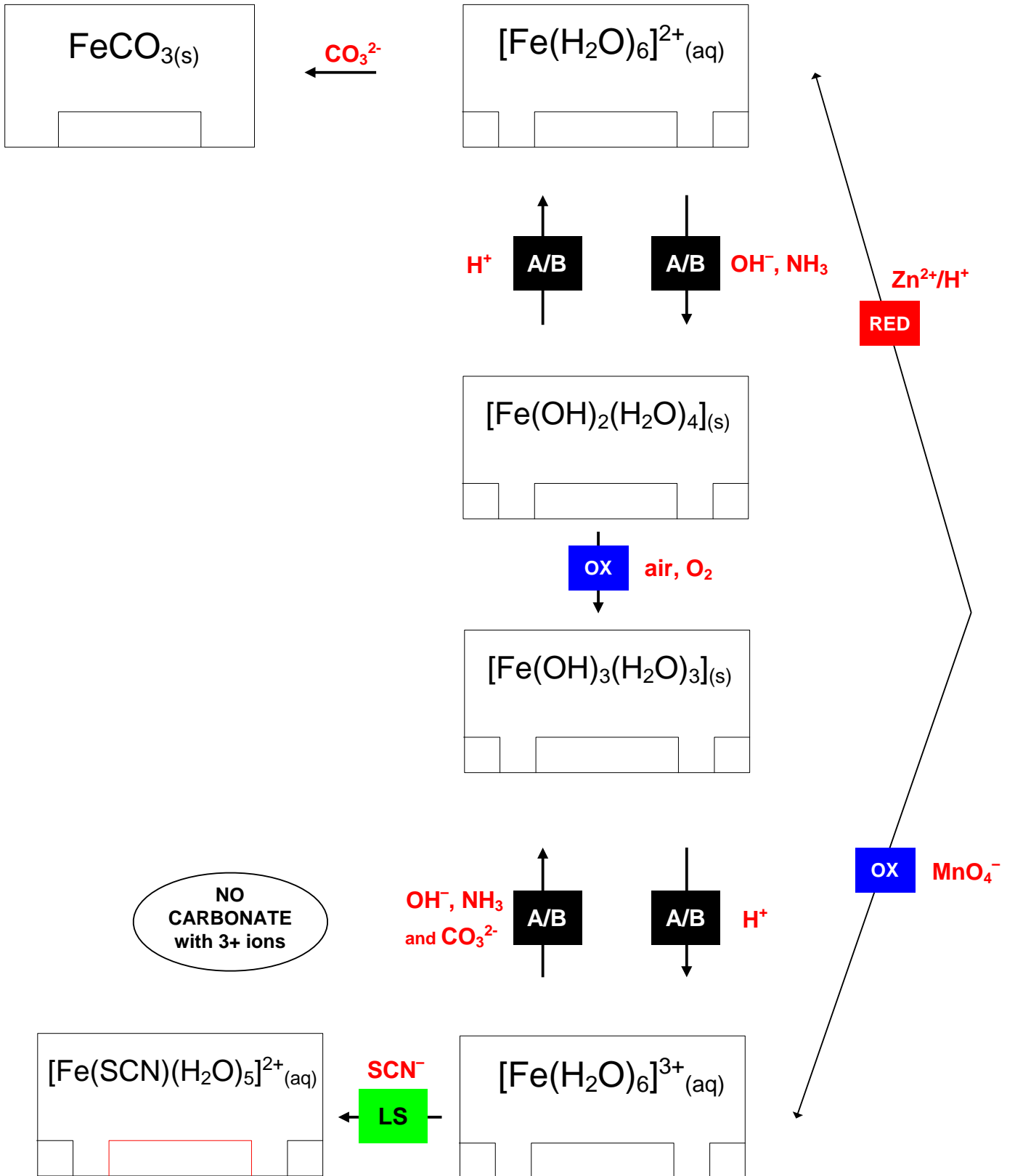



# CHROMIUM

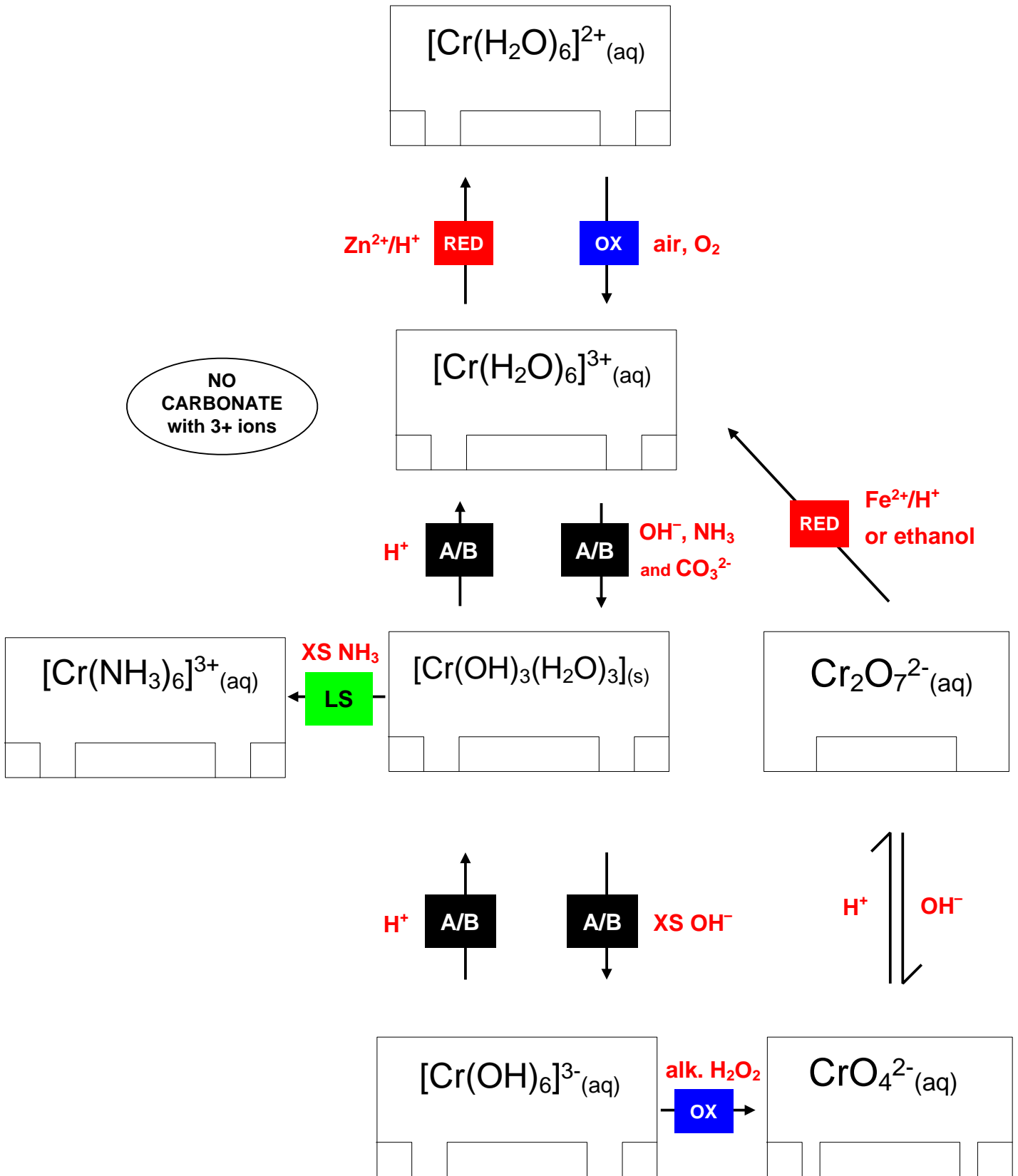

# ALUMINIUM

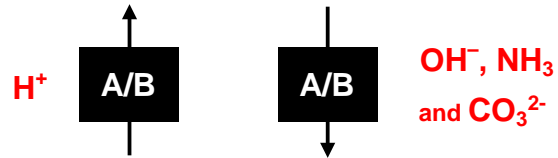
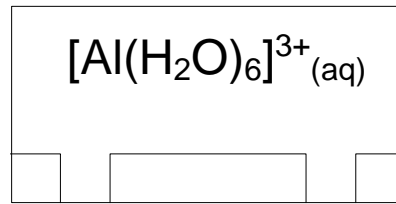

NO  
CARBONATE  
with 3+ ions

