

Centre Number						Candidate Number				
Surname										
Other Names										
Candidate Signature										

For Examiner's Use	
Examiner's Initials	
Question	Mark
1	
2	
3	
4	
5	
6	
7	
8	
9	
10	
TOTAL	



General Certificate of Education
Advanced Subsidiary Examination
January 2010

Biology

BIOL2

Unit 2 The variety of living organisms

Tuesday 19 January 2010 1.30 pm to 3.15 pm

For this paper you must have:

- a ruler with millimetre measurements.
- a calculator.

Time allowed

- 1 hour 45 minutes

Instructions

- Use black ink or black ball-point pen.
- Fill in the boxes at the top of this page.
- Answer **all** questions.
- You must answer the questions in the spaces provided. Answers written in margins or on blank pages will not be marked.
- You may ask for extra paper. Extra paper must be secured to this booklet.
- Do all rough work in this book. Cross through any work you do not want to be marked.

Information

- The marks for questions are shown in brackets.
- The maximum mark for this paper is 85.
- You will be marked on your ability to:
 - use good English
 - organise information clearly
 - use scientific terminology accurately.



J A N 1 0 B I O L 2 0 1

Answer **all** questions in the spaces provided.

- 1 (a) Name the process in which cells become adapted for different functions.

.....
(1 mark)

- 1 (b) Palisade cells are found in leaves. The diagram shows a palisade cell.

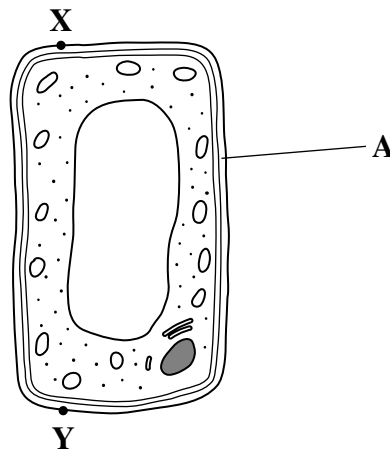

- 1 (b) (i) Name structure A.

.....
(1 mark)

- 1 (b) (ii) The real length of this cell between X and Y is 20 micrometres (μm). By how many times has it been magnified? Show your working.

Answer
(2 marks)

- 1 (b) (iii) Explain **one** way in which this cell is adapted for photosynthesis.

.....
.....
(1 mark)



2 In 2002, biologists identified a new group of insects. They called these insects gladiators.

2 (a) (i) *Mantophasma zephyra* is one species of gladiator. Complete the table to show how this species is classified.

Kingdom	Animalia
	Arthropoda
	Insecta
	Notoptera
Family	Mantophasmatodae
Species	

(2 marks)

2 (a) (ii) This system of classification consists of a hierarchy. Explain what is meant by a hierarchy.

.....

.....

.....

.....

(2 marks)

2 (b) In 2002, very few gladiators were available for identification. Scientists around the world used photographs to establish the relationship of gladiators to other insects. Explain how.

.....

.....

(1 mark)

5

Turn over ►



3 **Figure 1** shows a short section of a DNA molecule.

Figure 1

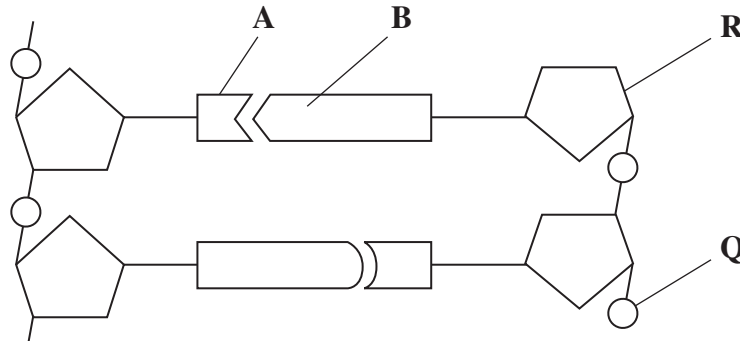

3 (a) Name parts **R** and **Q**.

3 (a) (i) **R**

3 (a) (ii) **Q**

(2 marks)

3 (b) Name the bonds that join **A** and **B**.

.....
(1 mark)

3 (c) Ribonuclease is an enzyme. It is 127 amino acids long.

What is the minimum number of DNA bases needed to code for ribonuclease?

(1 mark)



4 (a) An increase in respiration in the tissues of a mammal affects the oxygen dissociation curve of haemoglobin. Describe and explain how.

.....
.....
.....
.....

(2 marks)

4 (b) There is less oxygen at high altitudes than at sea level.

4 (b) (i) People living at high altitudes have more red blood cells than people living at sea level. Explain the advantage of this to people living at high altitude.

.....
.....
.....
.....

(2 marks)

4 (b) (ii) The graph shows oxygen dissociation curves for people living at high altitude and for people living at sea level.

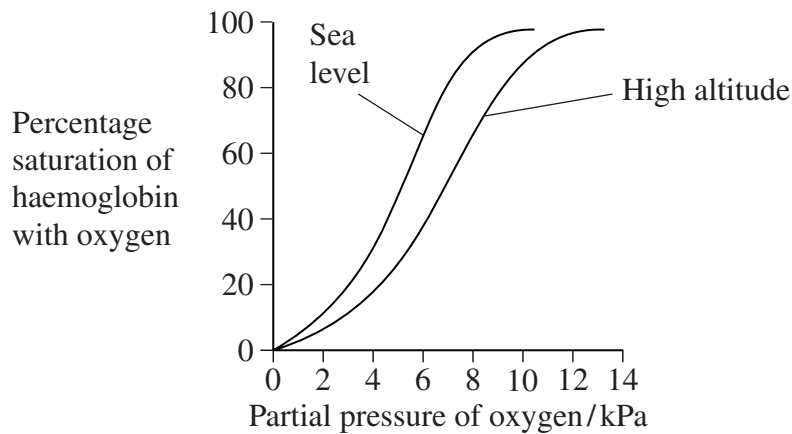

Explain the advantage to people living at high altitude of having the oxygen dissociation curve shown in the graph.

.....
.....
.....
.....

(2 marks)



5 A student found the number of stomata per cm² on the lower surface of a daffodil leaf. He removed a small, thin piece of lower epidermis and mounted it on a microscope slide. He examined the slide using an optical microscope.

5 (a) Explain why it was important that the piece of the epidermis that the student removed was thin.

.....
.....
.....
.....

(2 marks)

5 (b) Suggest how the student could have used his slide to find the number of stomata per cm².

.....
.....
.....
.....
.....
.....
.....

(3 marks)

(Extra space)

.....
.....

5 (c) The stomata on the leaves of pine trees are found in pits below the leaf surface. Explain how this helps to reduce water loss.

.....
.....
.....
.....

(2 marks)

Turn over ►



6 The diagram shows tissue fluid and cells surrounding a capillary.

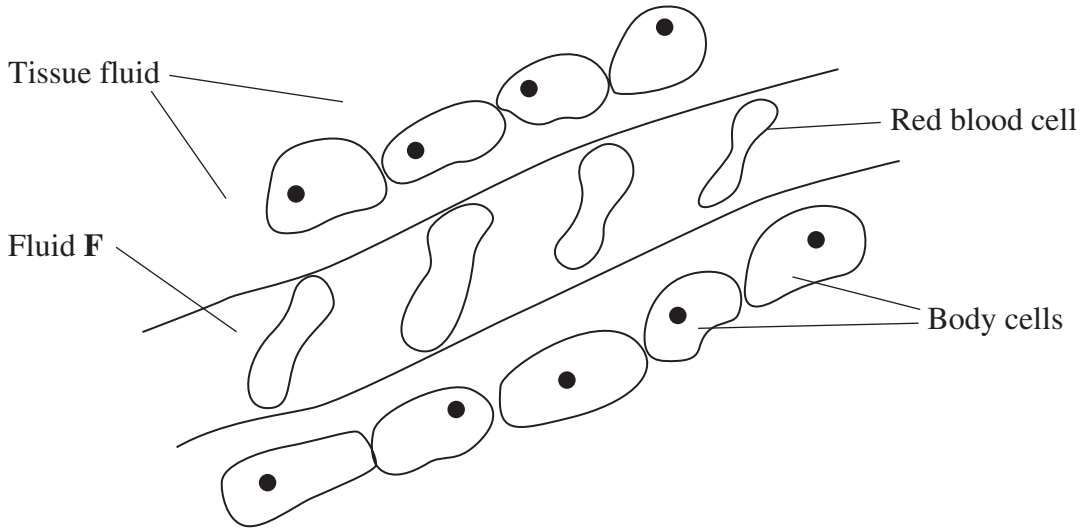

6 (a) Name fluid **F**.

.....
(1 mark)

6 (b) Give **one** way in which fluid **F** is different from tissue fluid.

.....
(1 mark)

6 (c) (i) The blood pressure is high at the start of the capillary. Explain how the left ventricle causes the blood to be at high pressure.

.....
.....
(1 mark)

6 (c) (ii) The blood pressure decreases along the length of the capillary. What causes this decrease in pressure?

.....
.....
(1 mark)



6 (d) In children, some diets may result in a low concentration of protein in fluid **F**. This can cause the accumulation of tissue fluid. Explain the link between a low concentration of protein in fluid **F** and the accumulation of tissue fluid.

.....

.....

.....

.....

.....

.....

(3 marks)

(Extra space)

.....

.....

7

Turn over for the next question

Turn over ►



- 7 (a) Heath is a community of plants and animals. A student investigated the species diversity of plants in this community. The table shows her results.

Plant species	Number of plants per m ²
Heath rush	1
Bilberry	1
Sheep's sorrel	5
Ling	2
Bell heather	1
Heath bedstraw	8
Mat-grass	11

- 7 (a) (i) The index of diversity can be calculated from the formula

$$d = \frac{N(N-1)}{\sum n(n-1)}$$

where

d = index of diversity

N = total number of organisms of all species

n = total number of organisms of each species.

Use this formula to calculate the index of diversity for the plants on the heath. Show your working.

Answer
(2 marks)



7 (a) (ii) Explain why it may be more useful to calculate the index of diversity than to record only the number of species present.

.....
.....
.....
.....

(2 marks)

7 (b) The demand for increased food production has led to areas of heath being used to grow wheat. Explain the effect of this on

7 (b) (i) the species diversity of plants

.....
.....
.....
.....
.....

(2 marks)

7 (b) (ii) the species diversity of animals.

.....
.....
.....
.....
.....

(2 marks)



8 (a) Gas exchange in fish takes place in gills. Explain how **two** features of gills allow efficient gas exchange.

1
.....
2
.....

(2 marks)

8 (b) A zoologist investigated the relationship between body mass and rate of oxygen uptake in four species of mammal. The results are shown in the graph.

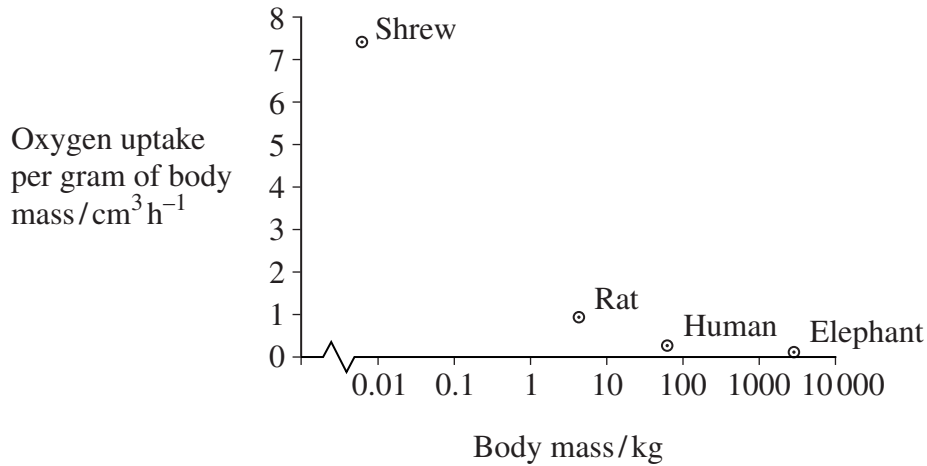

8 (b) (i) The scale for plotting body mass is a logarithmic scale. Explain why a logarithmic scale was used to plot body mass.

.....
.....

(1 mark)

8 (b) (ii) Describe the relationship between body mass and oxygen uptake.

.....
.....

(1 mark)



8 (b) (iii) The zoologist measured oxygen uptake per gram of body mass. Explain why he measured oxygen uptake per gram of body mass.

.....
.....
.....
.....

(2 marks)

8 (b) (iv) Heat from respiration helps mammals to maintain a constant body temperature. Use this information to explain the relationship between body mass and oxygen uptake shown in the graph.

.....
.....
.....
.....
.....
.....

(3 marks)

(Extra space)

.....
.....

9

Turn over ►



9 Taxol is a drug used to treat cancer. Research scientists investigated the effect of injecting taxol on the growth of tumours in mice. Some of the results are shown in **Figure 3**.

Figure 3

Number of days of treatment	Mean volume of tumour / mm ³	
	Control group	Group injected with taxol in saline
1	1	1
10	7	2
20	21	11
30	43	20
40	114	48
50	372	87

9 (a) Suggest how the scientists should have treated the control group.

.....

.....

.....

.....

(2 marks)

9 (b) Suggest and explain **two** factors which should be considered when deciding the number of mice to be used in this investigation.

1

.....

2

.....

(2 marks)



9 (c) The scientists measured the volume of the tumours. Explain the advantage of using volume rather than length to measure the growth of tumours.

.....
.....

(1 mark)

9 (d) The scientists concluded that taxol was effective in reducing the growth rate of the tumours over the 50 days of treatment. Use suitable calculations to support this conclusion.

(2 marks)

9 (e) In cells, taxol disrupts spindle activity. Use this information to explain the results in the group that has been treated with taxol.

.....
.....
.....
.....
.....
.....

(3 marks)

(Extra space)
.....
.....

Question 9 continues on the next page

Turn over ►



- 9 (f) The research scientists then investigated the effect of a drug called OGF on the growth of tumours in mice. OGF and taxol were injected into different mice as separate treatments or as a combined treatment. **Figure 4** and **Figure 5** show the results from this second investigation.

Figure 4

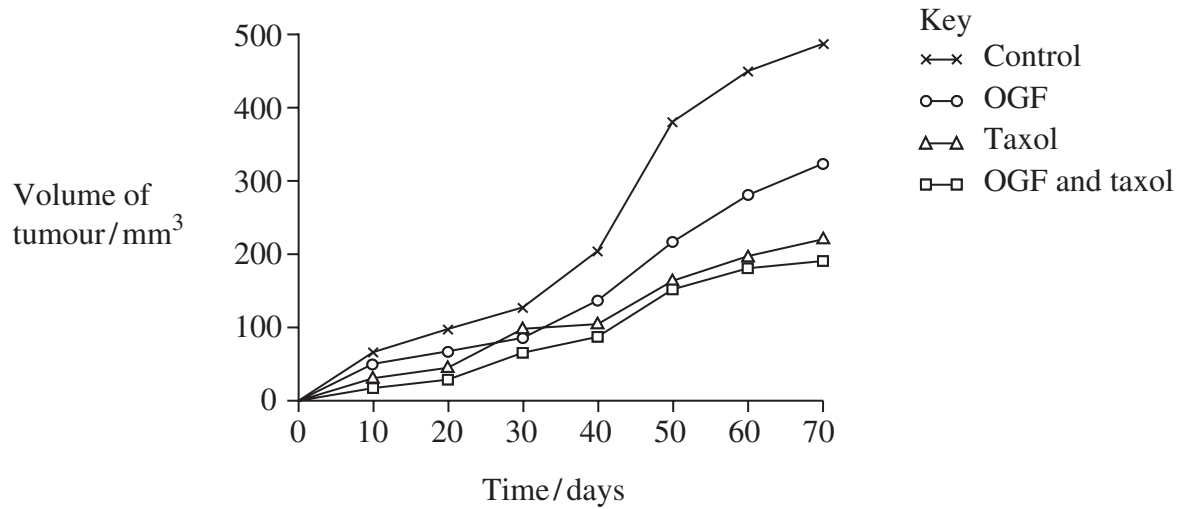

Figure 5

Treatment	Mean volume of tumour following 70 days treatment /mm ³ (± standard deviation)
OGF	322 (± 28.3)
Taxol	207 (± 22.5)
OGF and taxol	190 (± 25.7)
Control	488 (± 32.4)



9 (f) (i) What information does standard deviation give about the volume of the tumours in this investigation?

.....
.....

(1 mark)

9 (f) (ii) Use **Figure 4** and **Figure 5** to evaluate the effectiveness of the two drugs when they are used separately and as a combined treatment.

.....
.....
.....
.....
.....
.....
.....
.....
.....

(4 marks)

(Extra space)

.....
.....
.....

15

Turn over ►



10 The diagram shows a seahorse. A seahorse is a fish. Mating in seahorses begins with courtship behaviour. After this, the female transfers her unfertilised eggs to the male's pouch.

Most male fish fertilise eggs that have been released into the sea. However, a male seahorse fertilises the eggs while they are inside his pouch. The fertilised eggs stay in the pouch where they develop into young seahorses.

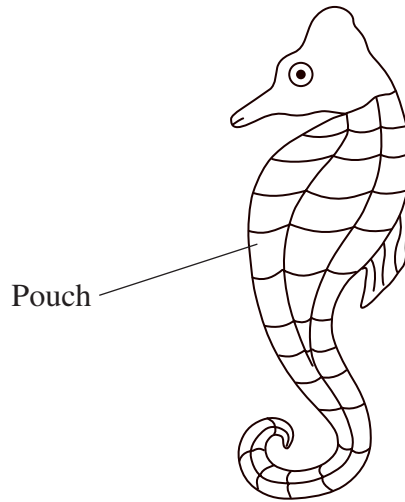

10 (a) Give **two** ways in which courtship behaviour increases the probability of successful mating.

1

2

(2 marks)

10 (b) Give **one** way in which reproduction in seahorses increases the probability of

10 (b) (i) fertilisation

.....
.....

(1 mark)

10 (b) (ii) survival of young seahorses.

.....
.....

(1 mark)



Scientists investigated the effect of total body length on the selection of a mate in one Australian species of seahorse. The scientists used head length as a measure of total body length.

- 10 (c) (i) Use the diagram to suggest why the scientists measured head length rather than total body length.

.....

 (1 mark)

- 10 (c) (ii) Suggest why the scientists were able to use head length as a measure of total body length.

.....

 (1 mark)

The scientists measured the head lengths of the female and male of a number of pairs. The results are shown in the graph.

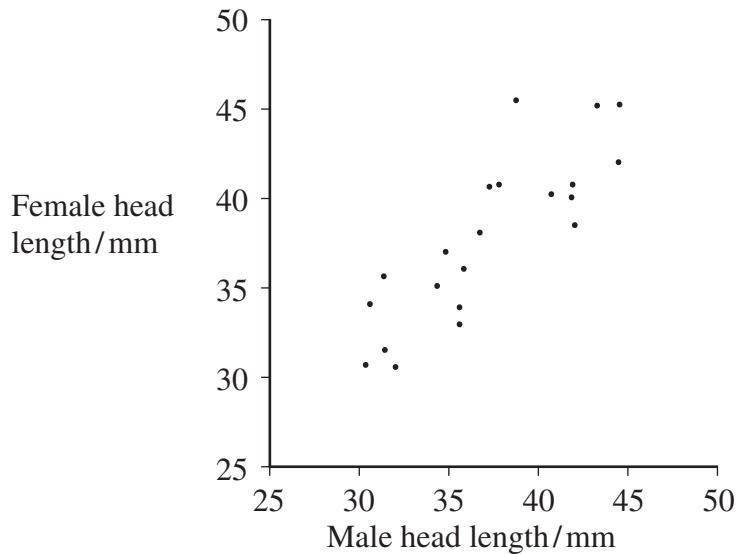

- 10 (d) The scientists concluded that total body length affects the selection of a mate. Explain how the results support this conclusion.

.....

 (1 mark)

Question 9 continues on the next page

Turn over ►



